

PREFACE

In a bid to standardise higher education in the country, the University Grants Commission (UGC) has introduced Choice Based Credit System (CBCS) based on five types of courses: core, generic discipline specific elective, and ability/ skill enhancement for graduate students of all programmes at Elective/ Honours level. This brings in the semester pattern, which finds efficacy in tandem with credit system, credit transfer, comprehensive and continuous assessments and a graded pattern of evaluation. The objective is to offer learners ample flexibility to choose from a wide gamut of courses, as also to provide them lateral mobility between various educational institutions in the country where they can carry acquired credits. I am happy to note that the University has been recently accredited by National Assessment and Accreditation Council of India (NAAC) with grade “A”.

UGC (Open and Distance Learning programmes and Online Programmes) Regulations, 2020 have mandated compliance with CBCS for all the HEIs in this mode. Welcoming this paradigm shift in higher education, Netaji Subhas Open University (NSOU) has resolved to adopt CBCS from the academic session 2021-22 at the Under Graduate Degree Programme level. The present syllabus, framed in the spirit of syllabi recommended by UGC, lays due stress on all aspects envisaged in the curricular framework of the apex body on higher education. It will be imparted to learners over the six semesters of the Programme.

Self Learning Materials (SLMs) are the mainstay of Student Support Services (SSS) of an Open University. From a logistic point of view, NSOU has embarked upon CBCS presently with SLMs in English. Eventually, these will be translated into Bengali too, for the benefit of learners. As always, we have requisitioned the services of the best academics in each domain for the preparation of new SLMs, and I am sure they will be of commendable academic support. We look forward to proactive feedback from all stake-holders who will participate in the teaching-learning of these study materials. It has been a very challenging task well executed, and I congratulate all concerned in the preparation of these SLMs.

I wish the venture a grand success.

Professor (Dr.) Subha Sankar Sarkar
Vice-Chancellor

Under Graduate Degree Programme
Choice Based Credit System (CBCS)
Subject: Honours in Geography (HGR)
Geomorphology and Climatology Laboratory (Practical)
Course Code : CC-GR-02

First Print : July, 2021

**Under Graduate Degree Programme
Choice Based Credit System (CBCS)
Subject: Honours in Geography (HGR)**

**Geomorphology and Climatology Laboratory (Practical)
Course Code : CC-GR-02**

**: Board of Studies :
Members**

Professor Kajal De

*(Chairperson)
Director, School of Sciences, NSOU*

Professor Apurba Rabi Ghosh

*Retd. Professor of Geography
University of Calcutta*

Dr. Biraj Kanti Mondal

Assistant Professor of Geography, NSOU

Professor Kanan Chatterjee

*Retd. Professor of Geography
University of Calcutta*

Ms. Tinki Kar Bhattacharya

Assistant Professor of Geography NSOU

Dr. Sriparna Basu

*Associate Professor of Geography
Sibnath Sastri College*

Dr. Asitendu Roy Chowdhury

*Retd. Associate Professor of Geography
Bhairab Ganguly College*

Dr. Jayanta Deb Biswas

*Retd. Associate Professor of Geography
Asutosh College*

: Course Writer :

Dr. Biraj Kanti Mondal

*Assistant Professor of Geography
Netaji Subhas Open University*

: Course Editor :

Dr. Jayanta Deb Biswas

*Retd. Associate Professor of Geography
Asutosh College*

: Format Editor :

Dr. Biraj Kanti Mondal

Notification

All rights reserved. No part of this book may be reproduced in any form without the written permission from Netaji Subhas Open University.

Kishore Sengupta
Registrar



**GEOMORPHOLOGY AND CLIMATOLOGY LABORATORY
[CC-GR-02]**

Module 1 : Geotectonics and Geomorphology Laboratory

Unit 1	<input type="checkbox"/> Interpretation of Indian Topographical Sheets	9-45
Unit 2	<input type="checkbox"/> Relative Relief map, Slope map (Wentworth)	46-53
Unit 3	<input type="checkbox"/> Correlation between physical and cultural features from topographical map	54-97
Unit 4	<input type="checkbox"/> Delineation of Drainage Basin and Construction of Hypsometric Curve	98-109
Unit 5	<input type="checkbox"/> Megascopic Identification of Minerals and Rocks	110-135
Unit 6	<input type="checkbox"/> Measurement of dip and strike using Clinometer	136-138
Unit 7	<input type="checkbox"/> Preparation and Interpretation of Simple Geological Map	139-163

Module 2 : Climatology Laboratory

Unit 1	<input type="checkbox"/> Measurement of Weather Elements using Analogue Instruments: Mean daily temperature, Air pressure	167-180
Unit 2	<input type="checkbox"/> Interpretation of a Daily Weather Map of India	181-209
Unit 3	<input type="checkbox"/> Construction and Interpretation of Climograph	210-214
Unit 4	<input type="checkbox"/> Construction and Interpretation of Wind Rose	215-216
Unit 5	<input type="checkbox"/> Construction and Interpretation of Climatic Chart	217-221
Unit 6	<input type="checkbox"/> Construction and Interpretation of Ombrothermic Chart	222-227

Module-1

Geotectonics and Geomorphology Laboratory

Learning Objectives

- 1) To study the Indian topographical maps in detail.
- 2) To extract geomorphic information from Survey of India topographical maps.
- 3) Construction and interpretation of relief profiles (superimposed, projected and composite).
- 4) To calculate and draw the morphometric maps, like Relative Relief map, Slope map (Wentworth).
- 5) To correlate between physical and cultural features from topographical maps using transect chart.
- 6) To delineate a Drainage basin from topographical maps and find out its properties.
- 7) To construct a Hypsometric curve from topographical maps.
- 8) To identify the rocks and minerals by observing their salient features.
- 9) To learn the use of clinometers to measure dip and strike.
- 10) To study different geological maps and learn to interpret by understanding the Horizontal, Uniclinal and Simple Anticlinal & Synclinal Fold Structure.

Unit-1 □ Interpretation of Indian Topographical Maps/ Sheets

Structure

1. Interpretation of Indian Topographical Sheets

1.1 Concept

1.2 Introduction

1.3 Extraction and Interpretation of geomorphic information from topographical maps/survey of India maps—

1.3.1 Map reading

1.3.2 Numbering of Topographical maps of India

1.4 Conventional Signs for Topographical maps of survey of India

1.4.1 Description

1.4.1.1 Villages, Buildings etc.

1.4.1.2 Water features

1.4.1.3 Telegraph lines

1.4.1.4 Railway and Bridges

1.4.1.5 Road and Bridges

1.4.1.6 Embankments

1.4.1.7 Boundaries, limits and Gardens

1.4.1.8 Ornamentation and Trees

1.4.1.9 High Mountain Features

1.4.1.10 Hill and Mountain Features

1.4.1.11 Heights, Trigonometrical Symbols

1.4.1.12 Coastal Symbols

1.4.2 Scientific Study of Topographical Maps

1.5 Key Features of Topographical Maps

1.5.1 Layout and Scale of Survey of India Topographical Sheets

1.5.1.1 Old Series Maps

1.5.1.2 Open Series Maps

1.5.2 Dimentions

1.6 Methods of Interpretation

1.6.1 Indentified Physical Features

1.6.2 (A) Miniature Map

(B) Broad Physiographic Divisions

1.6.3 Longitudinal Profiles

1.6.4 Serial Profiles

1.6.5 Superimposed, Projected and Composite Profile

1.1 Concept

Map interpretation is the systematic action of explaining the meaning, understanding, reading and execution of map. In it, a special attention given to the study of physical and cultural aspects potrayed on topographical maps or topo maps. It also gives emphasis on the relationship between the environmental setting and human activities, transportation, settlement and land use.

The topographical map shows the surface of the earth in detail. It covers small area but shows much greater detail of natural features such as relief, drainage, vegetation etc. and man-made features such as roads, railways, villages, towns, canals etc. Thus, a topographical map is a multipurpose map and serves as a guide to geographers especially for studing the regional geography of the area depicted on the map.

The topo-sheets or Topographical survey sheets are known *storehouse of information*. The study of any topographical sheet sharts with introduction of the marginal information which is generally given under the following heads.

i) The number of the sheet ii) Name of the state or district iii) The year of survey, publication of the map. iv) Magnetic variation from true north and its annual variation	→ Given on the upper margin of the sheet
v) Scale of the map vi) contour interval vii) Index to sheets viii) Administrative index ix) Grid reference	→ Given in the lower margin of the sheet
x) Longitudinal extent xi) Latitudinal extent xii) Height conversion table	→ Given on the side margins

Thus, the name of the state or district mentioned in the topo-sheets not only provide information on the location of the area, but also lights on the geologic structure, past climatological as well as other physical information along with the evolution of that particular area.

The account of a topographical map is generally written under the following headings:

1. Introduction
2. Relief feature
3. Drainage
4. Vegetation
5. Settlement
6. Transport and communication
7. Irrigation and Occupation
8. Other Features.

1.2 Introduction

Introduction of the map is given after physical and cultural elements are discussed and their possible interrelation is established. The information of topographic features from the map can be tabulated below:

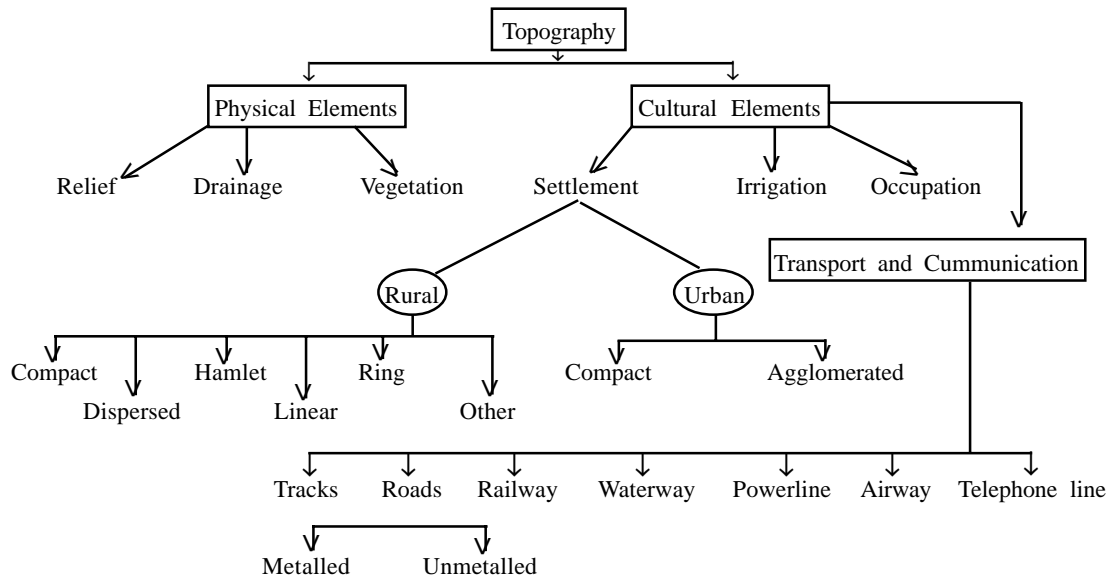

Relief is the actual configuration of land which includes its altitude and slope. On a topo-sheet, the study of relief includes a description of mountains, plateaus, plains, and the slope of the land. All the other physical features are mostly influenced by the relief. The relief features can be identified with the help of contours which are drawn in brown colors on the topo-sheet.

The mountains may be of different types, like Folded, Block, Dome, Volcanic, Erosional. The plateau may be of two types, Dissected and Volcanic. Moreover, the plateau may be further classified into six types, like— Diastrophic, Intermountainian, Border, Dome, Volcanic, Erosional. Thus, the plains may be of two types—Alluvial plains and Flood plains. Furthermore, the plains can be understood in a different way like,—(a) rolling, (b) alluvial, (c) dissected, (d) plains with knol, (e) plains with low hills of different shapes and sizes, (f) plains with plateau, (g) plains with plateau and hills, (h) plains with adjoining foot hills.

The entire area can make a general layout and the mountain, hills, valleys, plateaus, plains. After noting the broad features look carefully into the details of each one of them and mention the landforms like, peaks, ridges, hills, valleys, spurs, waterfalls, cliffs, knolls, saddles, cols, escarpment, gorges, watersheds, cirques, morrainic deposits etc. A number of profiles along important line should be drawn to indicate the nature of relief to identify different types of landforms.

The study and deep understanding of colours in the topo-sheets helps a lot to describe the physical features especially relief of the area. If there is sufficient number of contours, they follow irregular path and their value varies from 200 to 100 metres (600 to 3000 ft.), it is a plateau area. In such area we find waterfall, ridges, knolls, escarpments and undulating slope. Moreover, if however, the contours are larger in number, they are closer together, and their value exceeds 1000 metres (3000ft.), it is a mountain area. Such contour pattern shows steep slopes, v-shaped valleys, gorges, waterfalls, water divides etc.

The drawing of relief features, either by drawing perpendiculars or by paper strip, the description of the landforms undergoes by its interpretation.

Example:

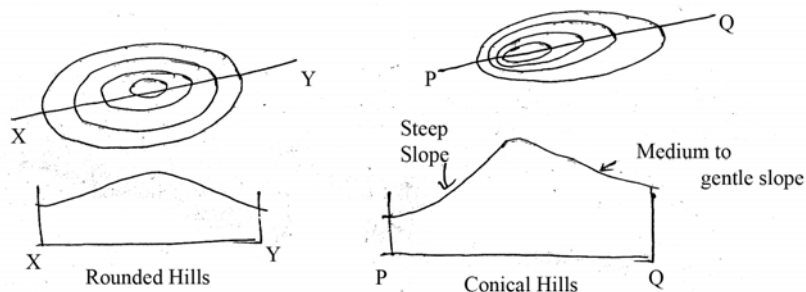

Fig:1 (A & B)

Here, the formation of rounded and conical hills must be described and then interpretation of the relief features can be done. In this regard, the two dimensional features of the topo map can be visualized and represented by its three-dimensional view.

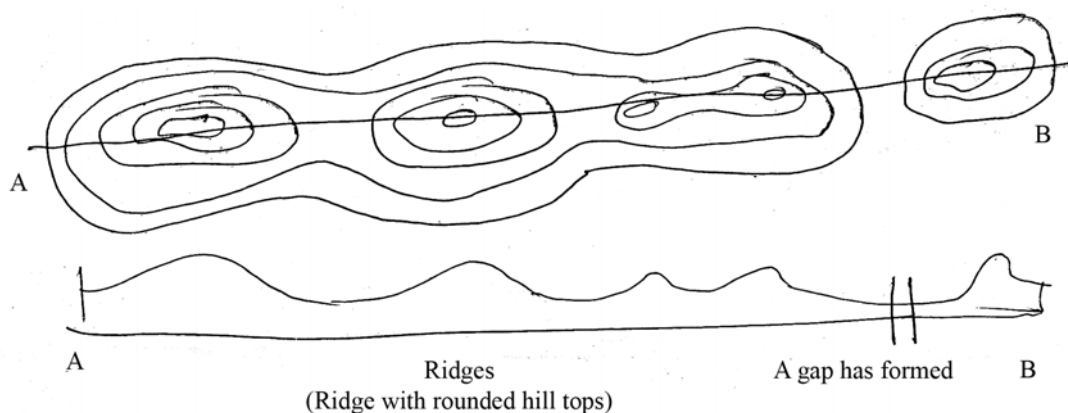

Fig.: 2

In this case, if you have a clear knowledge about geological as well as evolutionary history of the area, then in that case, probable cause for the formation of the ‘gap’ can be illustrated, though ‘filled imagination’ will give a much more precise information.

1.3 Extraction and Interpretation of Geomorphic Information from Topographical Maps/Survey of India Maps

1.3.1 Map Reading:

Map reading, in actuality, denotes the formation of a visual picture of the ground depicted on a map. Undoubtedly a map is a good guide but it requires some art to follow the direction and information given by it. It is not always easy to grasp the general appearance of the land at the first glance over the map, because various details may be recorded by a complex set of conventional signs on it. It requires a good deal of practice, and only a well-trained mind in this art can visualise the correct picture of the country represented by it. In fact, all types of map do not present the same difficulties in their reading as the *topographic survey map* in which the topographic forms are very well expressed by different symbols or signs in a complex manner. The best way to be familiar with the topography of a region is to compare the survey map of the region at the spot in the field. But before proceeding to the actual field, the students must be trained in the laboratory in consulting the map. Moreover, it is not

possible for a student even in his life-time to collect direct information from the field all over the earth; but one can easily manage to know of the different parts of the earth-surface from the topographical sheets thereof.

Though a map is the tool of a geographer, it is consulted by other people also. A traveller may, simply need to know about the location of his destination and the route followed; while in military strategy one may require to detect all possible routes along which to march or, which may be followed by the enemy. Thus, there are two methods of approach to a map. *Firstly*, a simple approach with some particular end in view, and *secondly*, a scientific approach. The simple approach points out to the mere consultations of the map; whereas a scientific study of map requires a critical outlook; it requires, at first, the collection of facts, their systematic arrangements and then deduction of suitable inferences. The first type of study is simple and it may be made even by a layman, but the second method is more elaborate and requires a comprehensive knowledge of physical geography as well as of human responses to natural environment, without which erroneous conclusions may be drawn. Obviously, this type of study is very useful to a student of geography in having a proper grasp of the regional geography of an area. A good practice in this type of practical work enables the student to write a systematic geographical account of any area.

1.3.2 Numbering of Topographical Maps of India :

The Survey of India was started over hundred years ago. Many great British surveyors received their training here. Due to their great effort our country is mapped on scales of 1, 2, 4 miles to the inch. But the most important are 1 : 1,000,000 scale maps, published in two series— (i) India and Adjacent Countries Series and (ii) the International Series of La carte. Internationale du Monde. The former also extends into the contiguous lands of Afghanistan, Tibet and China. These sheets are of 4×4 degrees. The whole country is planned to be divided in 4×4 degree sheets, each being numbered as 39, 40, 41, etc. Sometimes the sheet is named after the most important town of the area covered by it. For instance, sheet Nos. 43 and 53 are also known as Srinagar and Delhi sheets respectively. In these sheets lettering is done in black, water in blue, contours in brown, and roads and town sites in red colours. These sheets have been published in two editions. (i) Political edition with

administrative boundaries in colour, and (ii) Layered edition with graduated layers of colours to show altitudes. The publication of the latter has been stopped and in its place maps of International Series are being published. These sheets are also known as 1/M sheets or one-in-million maps. The maps of International Series are being prepared according to the scheme adopted by the International Map Committee held in London in 1909, for the whole world. In this Series elevation is shown in metres. Besides, some maps as “Southern Asia Series” have also been published on 1:2,000,000 or 2M scale by reducing one-in-million maps to half the scale. The colour scheme is the same as in 1/M maps. The one-in-million sheet has been further sub-divided into 16 equal sheets, each of one degree dimension as shown in Fig. 3. Each sheet is known as degree sheet as it represents only one degree extent. In Fig. 3 A, B, C, D, E, F, G, H, I, J, K, L, M, N, O and P are 16 degree sheets. They may be separately numbered as 63A, 63B, 63C etc., because they are parts

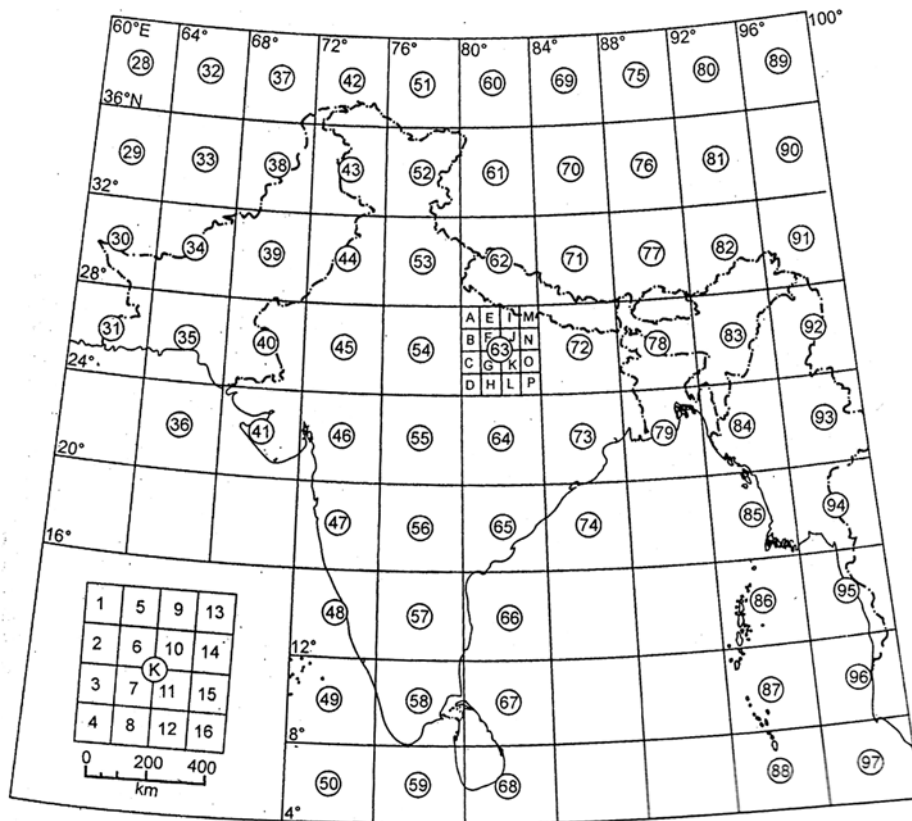

Fig.: 3

of the one-in-million map No. 63. They are also sometimes called quarter inch maps as they show a scale of 4 miles to the inch. The contour interval is generally 250°. The degree sheets have been again sub-divided into 16 equal sheets, each representing an extent of 15' (See the square 63 K in Fig. 3). These smaller sheets are one inch maps as they show a scale of one inch to a mile. Sheets showing an extent of 30' are known as half inch maps because they represent a scale of half inch to one mile. One inch maps are numbered as 63 K/1, 63 K/2, 63 K/3, 63 K/4 etc., while the half inch maps are numbered as 63 K/NW, 63 K/NE, 63 K/SE, and 63 K/SW, because they are in the corresponding directions from the centre of the 63 K degree sheet.

In selecting sheets for study, in the beginning simple sheets should be taken in which contours are not complicated but instead, they may be easily marked. For instance, a sheet representing a plain or plateau with low hills and ranges and clear drainage pattern may be selected. The sheets No. 63 K/12 may provide such simple features; a coloured sheet may be preferred because on coloured sheet vegetation and other features are very distinctly marked.

1.4 Conventional Signs for Topographical Maps of Survey of India

1.4.1 Description

1.4.1.1 Villages, Buildings, etc. :

(1) **Village**, as surveyed: (a) open (b) walled (2) **Ruined village** as surveyed. (3) **Scattered buildings and huts**: (a) permanently occupied, (b) temporarily occupied. (4) **Deserted site**. (5) **Mound** (6) **Sati** (7) **Factory Chimney** (8) **Cave** (when not antiquity): (a) inhabited, (b) uninhabited (9) **Picket or Post** (10) **Church** (11) **Temple** (12) **Tomb** (13) **Pagoda** (14) **Mosque** (15) **Idgah** (16) **Fort**: (a) surveyed (the thickness of line should be increased for large forts according to size and importance), (b) conventional (17) **Watchtower** (18) **Chhatra or way side temple** (19) **Battlefield** (with name and year) (20) (a) **Burial ground**, as surveyed. (b) **Graves**, (21) **Oilwell** (21A) **Oil-tank** (22) **Mine-shaft** (23) **Boundary pillar**: (a) Surveyed, (b) not found at time of survey. (24) **Rifle-range**, (as surveyed) (25) **Aerodrome**: (a) as surveyed, (b) conventional (26) **Landing ground**:

(a) as surveyed (b) conventional **(27) Air bombing (or firing) range**, as surveyed. **(28) Air bombing target (29) Air firing target (30) Air mooring or Tall telegraph mast. (31A) Seaplane alighting area. (31B) Seaplane station. (31C) Trijunction pillars:** (a) when village boundary is shown, (b) when village boundary is not shown.

1.4.1.2 Water Features :

(32) Well: (a) lined or in rock, (b) unlined **(33) Spring (34) Karez** (with) depth of shaft in feet) (a) in use, (b) disused. **(35) Pipe line:** (a) water, (b) oil, **(36) Swamp or marsh**, with cultivation. **(37) Reeds** in perennial water. **(38) Lake or tank**, as surveyed: (a) with defined limit of perennial water, (b) with fluctuating, limit of perennial water, (c) with embankment under 10 ft. (d) with embankment 10ft or over, (e) with very steep embankment. **(39) Excavated tank**, as surveyed: (a) perennial, (b) non-perennial, (c) perennial with high embankment **(40) Tank**, conventional: (a) perennial, (b) non-perennial, **(41) Quarry**, with greatest depth, **(42) Singleline stream:** (a) perennial, (b) non-perennial, (c) approximate or undefined, (d) indicating change from non-perennial to perennial. **(43) Stream bank**, north bank shows continuous, unbroken, steep or precipitous bank from 1' to 100' or over, in height, and south bank shows the same, but broken, as surveyed, heights corresponding with those on the north bank: (a), (b) and (c) show treatment of side stream junctions in accordance with the extent to which the river-bank is broken, (d) breaks in banks that extend to river bed level, (e) small breaks that have not been eroded down to river bed level, (f), (g) and (h) types of gorges or narrow rivers with high banks. **(44) Dry nala:** (a) with broken ground along bank (as surveyed), (b) ravines (as surveyed) **(45) Double-line stream** (width 1/20 inch or more on published sheet): (a) perennial, with narrow showing direction of flow, (b) dry with sandy bed. **(46) Waterfall** with height (perennial and non-perennial). **(47) Rapids. (48) Sluice. (49) Perennial canal** with distance stone: (a) single-line (thickness according to importance), (b) double-line according to width and with embankment shown be relative height. **(50) Non-perennial canals** with distance stone. **(51) Disused canals. (52) Canal:** (a) with navigation lock, (b) with lock or weir carrying— (i) road, (ii) foot-path, (c) aqueduct or (if printed in black or red) viaduct **(53) Dam:** (a) masonry, (b) earth work. **(54) Weir** (Anicut in Madras): on single-line and narrow double line streams, the sluice symbol should be used with the word 'Weir' typed alongside. **(55) Canal tunnel**, with or without cutting, surveyed. **(56) Siphon** in perennial canal (black in case of non-perennial canal).

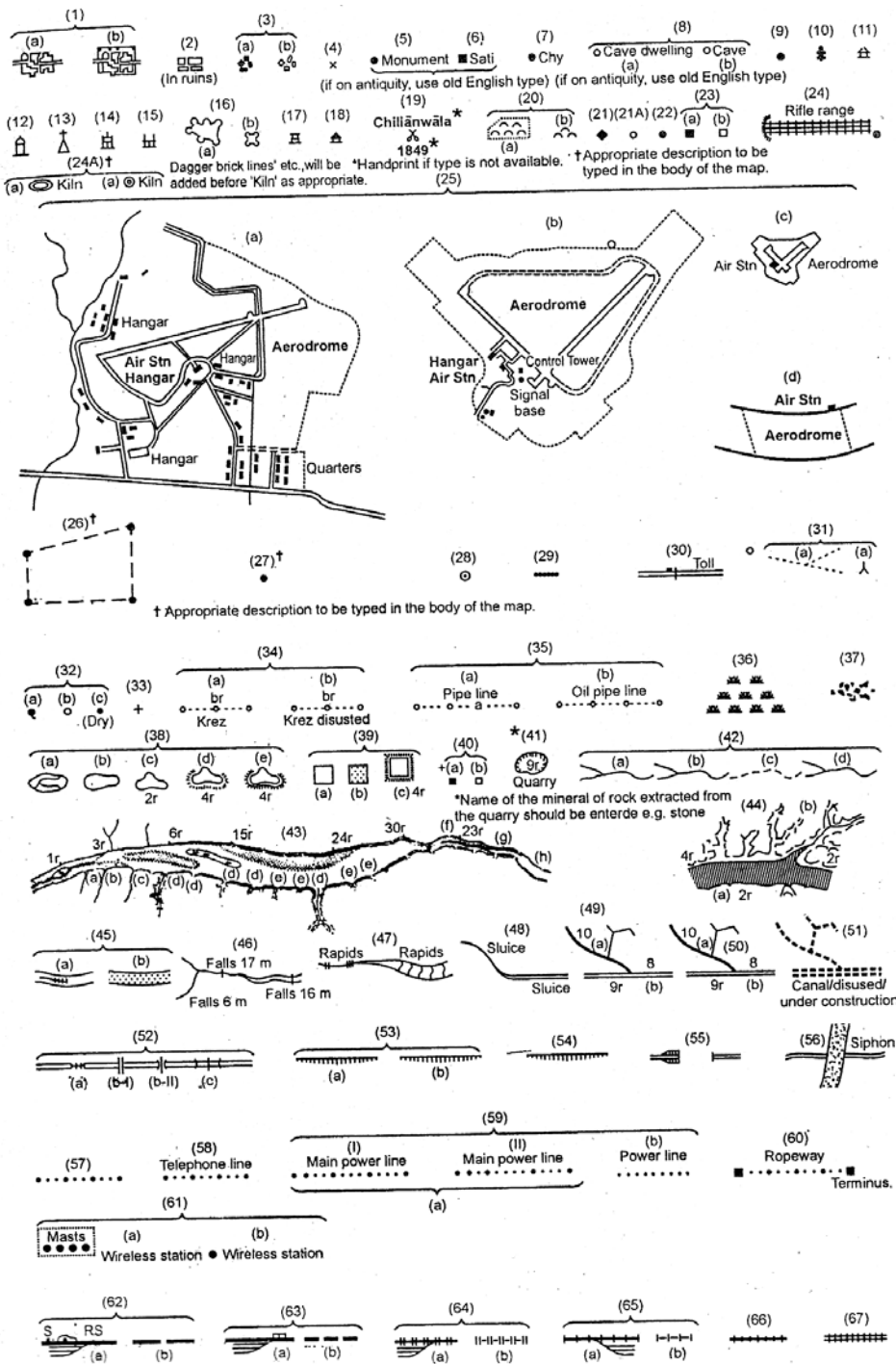

Fig.: 4

1.4.1.3 Telegraph lines :

(57) Telegraph line. (58) Telephone line. (59) Electric Power line: (a) main transmission line (i) conventional on all scales, (ii) where spans vary largely the position of pylons should be as surveys when suitable to the scale, (b) local distribution line (conventional): for lines of intermediate importance the size of the large dots will be graduated between symbols (a) as surveyed, (b) conventional.

1.4.1.4 Railway and bridges:

(Gauge, if other than 5'-6', should always be stated)

(62) Railway, 5'-6' gauge double-line: (a) open with sidings, mile stone and station with enclosure (as surveyed), (b) under construction **(63) Railway, 6'-6" gauge single-line:** (a) open with sidings, and station and enclosure (conventional): (b) under construction. **(64) Railway, other gauges double-line:** (a) open with sidings, (b) under construction. **(65) Railway, other gauges single-line:** (a) open with sidings, (b) under construction, [In symbols (62) to (65) the sidings may be drawn narrower when space is limited]. **(66) Mineral line or tramway. (67) Level crossing. (68) Road over railway. (69) Road (or railway) under railway. (70) Railway tunnel,** with or without cutting, as surveyed. **(71) Bridge carrying railway. (72) Bridge carrying:** (a) railway over road, (b) road over railway (the descriptive wording should be omitted only where there is no room). **(73) Bridge carrying road and railway of:** (a) 5'-6" gauge, (b) other gauges.

1.4.1.5 Roads and bridges:

(74) Roads of 1st importance: (a) metalled, and important bridge with piers over river (the normal distance between the piers should be 1/8" on scale of drawing, varying slightly to permit of equal spacing between piers), (b) unmetalled **(75) Roads of 2nd importance:** (a) metalled, (b) unmetalled **(76) Other roads:** (a) metalled, also mile stone, bridge and Irish bridge or causeway, and avenue of trees, (b) unmetalled (c) motor transport turning point on roads. **(77) Cart-track with bridge. (78) Pack-track with bridge culvert. (79) Pack-track with pass and height. (80) Foot-path with bridge, culvert.** In symbols (77 to 80) the heavier symbols should be used in afforested or contoured areas, or where emphasis is required in open areas. Symbols may be still heavier if required to give emphasis in afforested or contoured areas, **(81) Road**

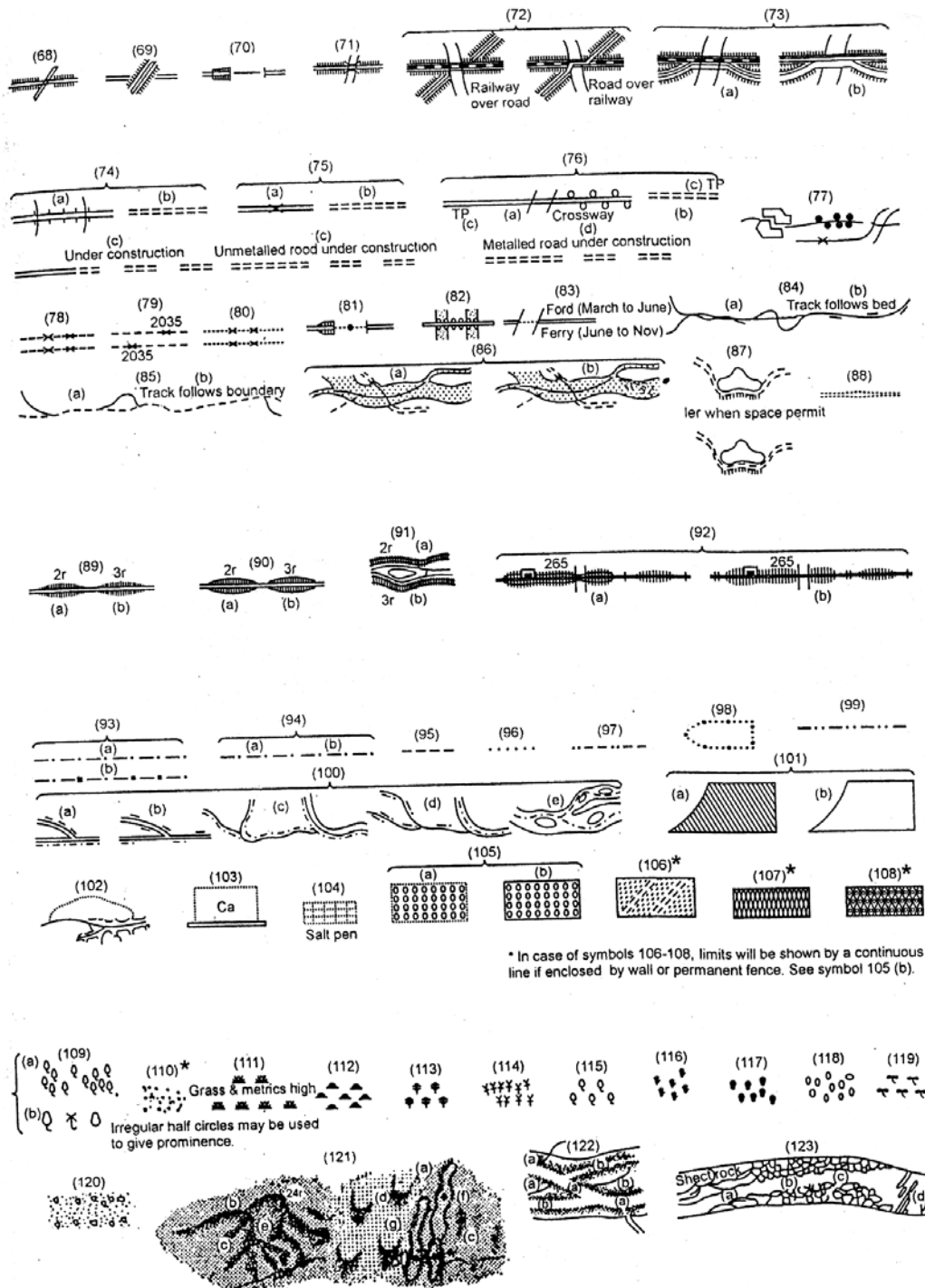

Fig.: 5

tunnel, with or without cutting, as surveyed.

(82) Bridge or boats or pontoon bridge (explanatory words to be typed against the symbol). **(83) Ferry or ford.** **(84) Track or path coincident with bed of stream:** (a) for short distance, (b) long distance. **(85) Track or path following notified boundary:** (a) short distance, (b) long distance. **(86) Roads in dry river bed:** (a) with steep river banks, (b) with shelving river banks. **(87) Unmetalled road along tank bund.** **(88) Forest fire-line**, not in regular use as line of communication, race-course track and similar special cases (explanatory words to appear along the symbol but when in regular use as line of communication the appropriate road symbol is to be used.

1.4.1.6 Embankments:

(89) Road or railway embankment: (a) 5ft to 9ft high, (b) 10ft high or over and steep with sharp edge at top. **(90) Road or railway cutting:** (a) 5 to 9 ft deep, (b) 10ft deep or more and steep, with sharp edge at top. **(91) Protective embankment:** (a) 5ft to 9ft high, (b) 10ft high or over steep, with sharp edge at top **(92) Embankments, cuttings and bridges with narrow gauge railway** (Sleepers omitted) (a) along single-line, (b) along double-line (**Note:** (“Single line” or “Double line” may be typed along the line, if necessary)

1.4.1.7 Boundaries, limits and Gardens:

(93) International: (a) demarcated, (b) undemarcated. **(94) Province or State:** (a) demarcated, (b) undemarcated **(95) District or Tribal (96) Sub-division, Township, Taluk, Tahsil, Zamindari or similar partition. (97) Pargana in U.P. (98) Reserved, Protected or State Forest** (green riband with appear along the external boundaries and along those between forests of different ownerships. **(99) Village with trijunction pillar:** In symbols 93 to 99 boundary pillars should be drawn first, fitting in the boundary symbol afterwards, even if the length of bars does not agree. **(100) Boundaries along:** (a) one side of road, track or path, (b) center of road, track or path (when it is recognised boundary), (c) one side of river, (d) centre of river (e) bed of river as surveyed. **(101) Wooded area** (a) not enclosed, (b) enclosed by wall or permanent fence. **(102) Limits of cultivation**, open and along stream or ravine. **(103) Demarcated limits camping ground. (104) Salt pan. (105) Orchard garden:** (a) not enclosed, (b) enclosed by a wall permanent fence. **(106) Tea garden**, as survey **(107) Betel or vine** on trellis. **(108) Vegetable garden.**

1.4.1.8 Ornamentation and Trees:

(109) Scattered trees. (110) Scrub and undergrowth. (111) Grass: high (112) Cane-brake (113) Pine, fir, etc. (114) Palm. (115) Palmayrs (116) Betelnut (117) Bamboo. (118) Aloes or cactus. (119) Other trees. (120) Plantain trees.

Symbols (109) to (120) can be varied slight by size. Trees surveyed individually will appear in black, grass and all other tres will appear in green. Authorised symbols will be used where suitable, a wooded areas small circles and half circles representing tres of uncertain nature, and representing scrub, under-growth or tea bushes, may be mixed with actual symbols which should very with the character of the vegetation. Symbols should not be drawn with elaborate care except when isolated.

(121) Stony waste, (122) Sand features: (a) sand hills and dunes, shape as surveyed, (b) shifting sand, (c) confused sand hills (conventional), (d) fla sandy areas, Loose free sand should be indicated by closer spacing of dots. **(123) Sandy river bed** showing: (a) perennial channels, (b) non-perennial channels. **(124) River bed** showing: (a) sheet rocks, (b) rounded rocks, (c) edged rocks, and (d) rock ribs.

1.4.1.9 High Mountain Features:

(125) Snow, ice and rock forms: (a) Medial moraine, (b) Lateral moraine, (c) Terminal morain, (d) Hanging glacier, (e) Ice fall, (f) Crevasses due to uneven bed, (g) Crevasses due to movement of ice stream, (h) Ice pinnacles, (i) Bergschrunds, (j) Permanent snow (ne ve), (k) Ice wall, (l) Glaciere stream and lake, (m) Ice cave, (n) Ice couloir, (o) Rock couloir (p) Scree (q) Rock fall (large rocks) (r) Recognised route over glacier, with pass, (s) Snow cornice.

1.4.1.10 Hill and Mountain Features

(126) Contours, with form-lines showing sub-features and contour value. **(127) Depressions or Devil's cauldrons. (128) Broken or rocky ground. (129) Sheet rock on mountain side, with rock pinnacles. (130) Scarp or cliff; high. (131) Scarp or cliff: medium (about 20' to 50'). (132) Scarp or cliff: low. (133) Earth or gravel slide. (134) Isolated rock masses (shape as surveyed). (135) Rock outcrops with and without scattered boulders. (136) Sheet rock. (137) Terraced scarps. (138) Rocky knobs. (140A) Mud Volcanoes, etc.:** as surveyed— (a) Crater, (b) Pinnacles. (c) Mud vent, (d) Mud flow: conventional, (e) Pinnacles, (f) Crater.

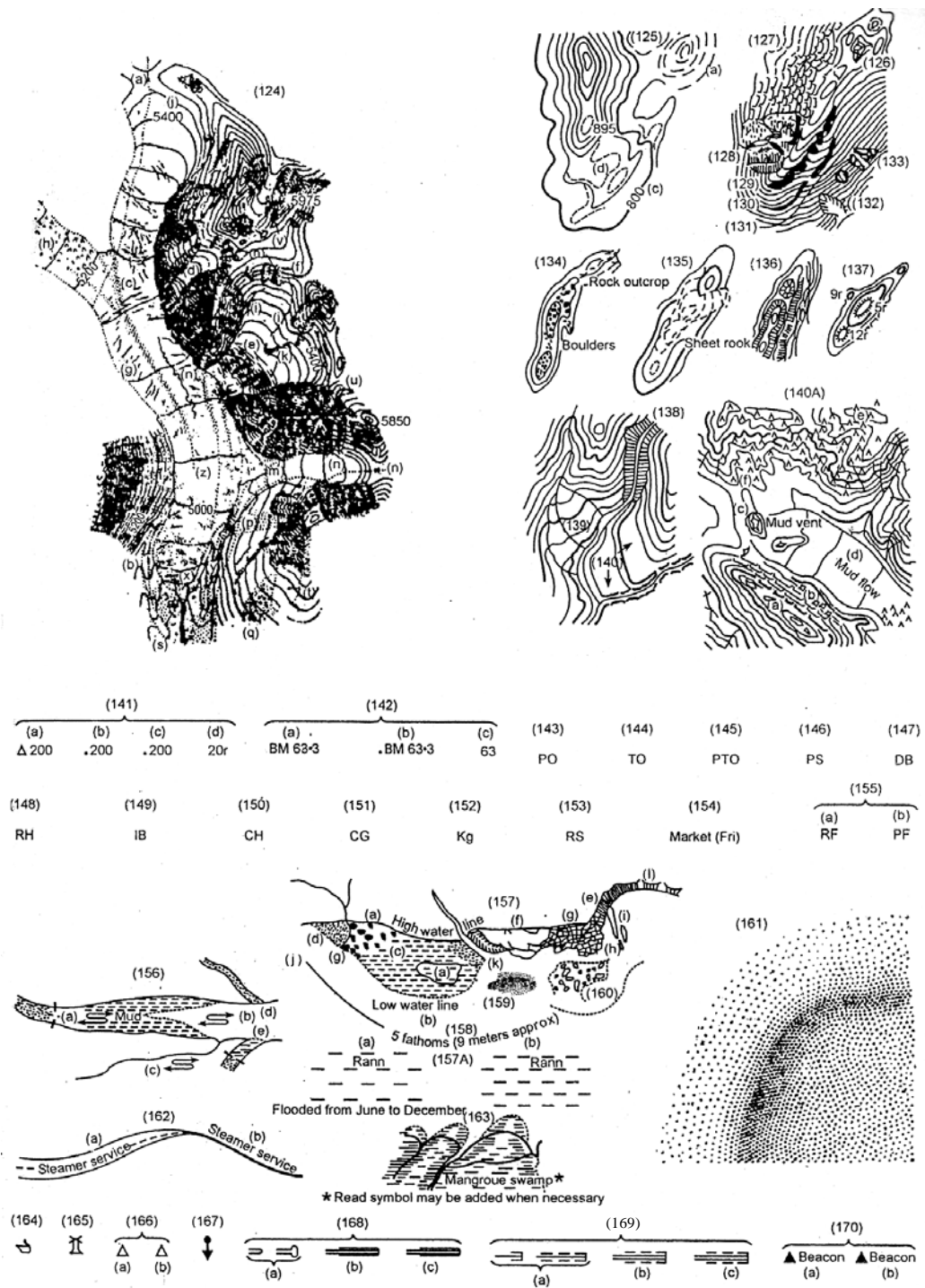

Fig.: 6

Note : The rock forms depicted in symbols (125) and (128) to (138) are shown in their most usual surroundings; they are not, however, to be confined to the type of country shown in the specimens but should be drawn illustrated whenever they occur. The list of feature is not exhaustive.

1.4.1.11 Heights, Trigonometrical Symbols

(141) Heights: (a) Triangulation station, (b) Triangulation interested point or permanent traverse station or intersected point, with ground level accurately fixed or measured, (c) (vi), (d) approximate, (e) relative, **(142) Bench-mark**, with height to the nearest foot: (a) geodetic, (b) canal, (c) others. **(143) Post Office. (144) Telegraph Office. (145) Combined post and telegraph office. (146) Police station.**

(147) Dak bungalow, (148) Rest-house. (149) Travellers bungalow. (150) Inspection bungalow (151) Circuit house. (152) Camping-ground. (152) Buddhist kyaung. (153) Railway station. (154) Market or bazar with day. (155) Forest: (a) Reserved, (b) Protected, (e) State, (d) Zamindari.

1.4.1.12 Coastal Symbols:

(156) Tidal water: (a) with limit in double line dry stream, (b) in double-line perennial stream (c) in single-line stream, (d) with definite bank in the junction with a double-line dry stream, (e) without definite bank at the junction.

(157) Coast-line as surveyed, showing: (a) high water line, (b) low water line, (c) tidal flat with mud, (d) shingle and sand, (e) cliff, (f) sheet rock, (g) rounded rocks with sand, (h) edged rocks (i) rock ribs, (j) single-line stream in foreshore. **(158) Fathom-line. (160) Submerged sand. (161) Submerged rocks with danger line. (162) Steamer service:** (a) in double-line river, (b) in single-line river.

(163) Mangrove swamp. (164) Lightship. (165) Light-house. (166) Buoy: (a) lighted, (b) unlighted. **(167) Anchorage. (168) Pier or jetty** (masonry): (a) conventional, (b) carrying railway as surveyed **(169) Pier or jetty** (open. framework or piles): (a) conventional, (b) carrying, road as surveyed, (c) carrying railway as surveyed. **(170) Beacon, steamer signal, navigation mark, etc.** of a fairly permanent character (with appropriate lettering typed against the symbol): (a) lighted, (b) unlighted.

1.4.2 Scientific Study of Topographical Maps

1. Preliminary information: (a) Note the nature, number and scale of the sheet, (b) measure the area of the sheet into square miles by the scale; (c) find out the districts represented by the sheet and also the adjoining districts with reference to the index below the sheet; (d) note down the latitudinal and longitudinal extent of the area depicted on the sheet.

2. Observation of the topography : Topography is the expression of the interaction of physical and cultural environments, and as such it includes physical as well as cultural (man-made) elements which are charted below.

As already indicated in the foregoing, these features are marked over the sheet by some definite symbols—*conventional signs* and colours which are generally used to aid legibility in the map. Maps may be both coloured and uncoloured. Generally seven colours have been used in coloured maps. Hills are shown by brown contours or hachures and grey shades, water-courses are blue, forest are green, cultivated areas are yellow, railways are black and roads, towns and villages are red. These are shown on the “Characteristic sheet of the conventional signs and writing” used for British Ordinance Survey maps and some are also given on the margins of the map. Every country follows, more or less, the same conventional signs, with a few additions or a little alterations. In the topographical survey maps of India. British symbols have been adopted. In some maps more symbols are required, while in others only a few will do; for instance, in one inch maps less symbols are used than in *cadastral maps*, whereas quarter inch maps and 1/ m maps require less symbols than one inch maps. The student should, however, be familiar with these symbols to be able to identify various features on the map. For convenience the conventional signs are given earlier.

3. Picturing the sheet as a whole: Ignoring the details for the time, picture the map as a whole. Do not look too closely at the map but try to have an idea of the most outstanding features of the landscape depicted on it. In the first place you should identify whether the area exhibits one type of physical feature— plain or plateau or hill, etc. If it includes more than one type, try to divide the area into sub-regions so that appropriate and systematic description may be given. For this purpose observe carefully the main river valleys and main contours indicating high and low lands which will enable you to divide the area into different units. In this

connection it may be noted that the nature of rocks is not legible on such maps, so only by the character of drainage it may merely be hinted whether it is a limestone region of any other region.

4. Observing the relief: After recognising the major units of relief, primary landforms—peaks, ridges, hills, spurs, escarpments, knolls, cols, etc. should be noted as identified. For this trace out important contours on a piece of paper and along suitable lines across them draw one or more profile sections which will give a clear conception of landforms. Drawing of sections to identify landforms is necessary only in the beginning. After a good deal of training and practice, the relief features can be marked only by eye-observation of the map. The profile sections will enable you to use appropriate adjectives to typical features, just as for ridge: long, narrow or board, steep-sided or with gentle slopes—closely spaced contours expressing steep slopes and widely spaced contours indicating gentle slopes; for hills: rounded.

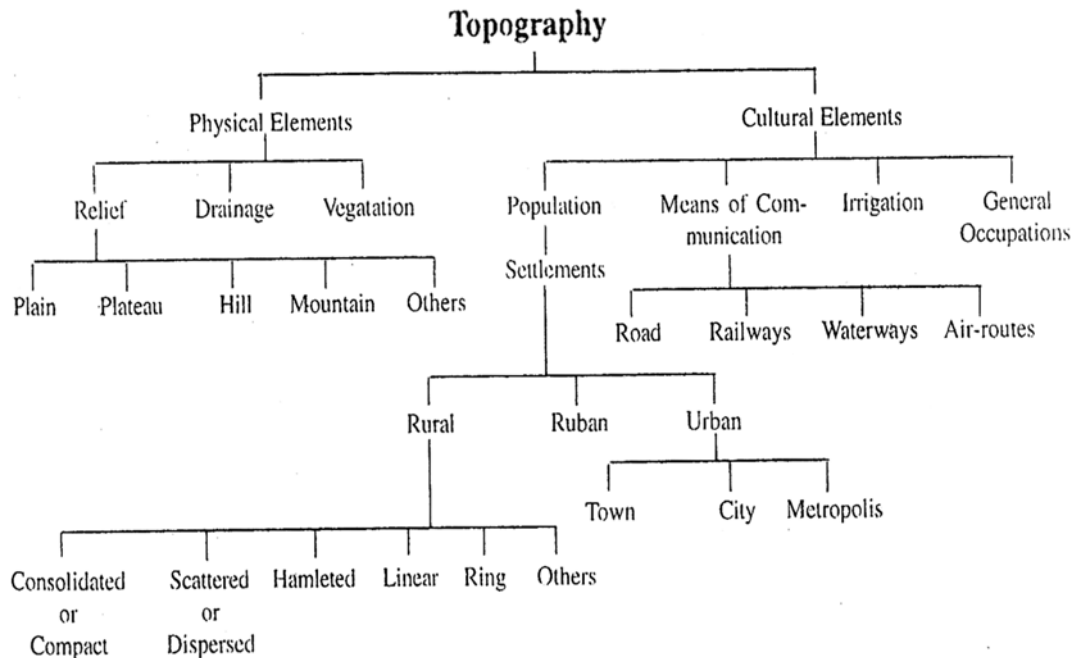

1.5 Key Features of Topographical Map

A *topographical map* or a *tipomap* or a *toposheet*, as it is generally called, shows the surface features of the earth as it exists during the period of survey in as much detail as the scale allows by means of *cartographic* and *conventional symbols*. As it presents the ground in great detail, it is a *storehouse* of all information necessary to understand and comprehend both the physical and human geography of an area. Thus it forms the most important *practical tool* of a geographer. The ability to interpret a topographical map is fundamental to the understanding of the geography of an area. For this, it is necessary to study the map in detail through three distinct tasks—*first*, identifying the geographical features shown by conventional symbols (point, line, area, letter, colour); *second*, measuring their attributes and spatial patterns; and *third*, comprehending their occurrence and origin. Mapcraft is a special skill by which a mental picture of the ground is constructed from a map and is basic to map reading and interpretation.

1.5.1 Layout and Scale of Survey of Indian (SOI) Topographical Sheets

The survey of India (SOI), the National Survey and Mapping Organisation of India under the Department of Science & Technology, is the oldest scientific department of the Government of India. With headquarters at Dehradun, Uttaranchal, it was set up in 1767 and has evolved rich traditions over the years. The tapestry of the Indian terrain was completed by the painstaking and pioneering efforts of a distinguished line of British surveyors led by Mr. Lambton and Sir George Everest.

The then British surveyors mapped the area of land between (44°E, 4°N) and (104°E, 40°N) covering the whole of the then Indian subcontinent and a vast portion of Asia (**Table-1**). In this layout, the above area was first divided into 106 uniform rectangles of (4°×4°) dimension and were designated by *numerals*, 1–106 (**Fig. 7**). These were drawn on a 1 inch to 16 miles scale (1:1,000,000) and are known as *million sheets* or 1M Sheets. Each 1M sheet contains 16 degree sheets of (1°×1°) dimension drawn on a 1 inch to 4 miles scale (1:250,000) and are designated by *alphabets* A–P. A degree sheet is then further divided in two ways. *Firstly*, each such sheet contains 4 *quadrant sheets* of (30'×30') dimension drawn on a 1 inch to 2 miles scale and designated by NW, NE, SW and SE and *secondly*, each degree sheet contains 16 *inch sheets* of (15'×15') dimension drawn on a 1 inch to a mile scale and are designated by *numerals* 1–16.

1.5.1.1 Old Series Maps—

Table 1: Layout of Indian Topographical Maps on the Old Scale

Name	Scale	Extension	Contour Interval (ft.)	Reference No. (example)
Million Sheet or 1M Sheet	1 inch to 16 miles	4°×4°	500	72
Degree Sheet or Quarter-inch Sheet	1 inch to 4 miles	1°×1°	250	72F
Half-inch or Half-degree or Quadrant Sheet	1 inch to 2 miles	30'×30'	100	72 F/NE
Inch Sheet or 15' Sheet	1 inch to 1 mile	15'×15'	50	72 F/10

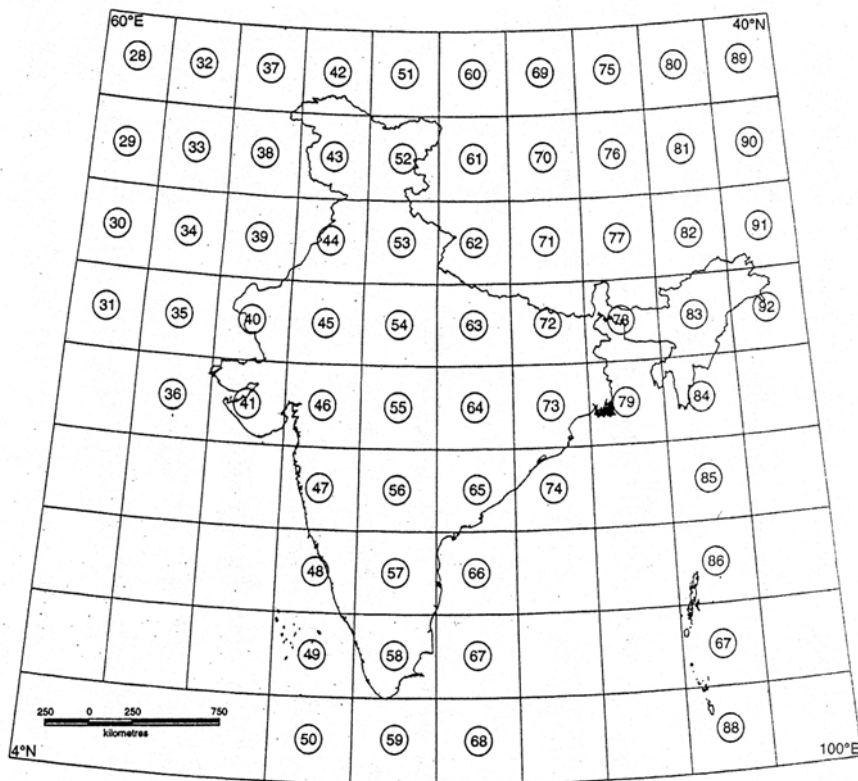

Fig 7: Layout of Million Sheets Conveing the Indian Subcontinent

In the late 1970s, topographical maps were redrawn on metric scales using updated information from both ground and aerial surveying (**Table 2**). More detailed maps were drawn on 1:25000 and referenced in two ways. *Firstly*, some of the 1:50000 sheets have been printed off on old layouts, i.e., each 1:50000 sheet contains six 1:25000 sheets on (7'30"×5') dimension and are designated by *numerals* 1–6 and *secondly*, each 1:50000 sheet contains four 1:25000 sheets of (7'30"×7'30") dimension, designated as NW, NE, SW and SE.

Table 2: Layout of Indian Topographical Maps on a Metric Scale

Name	Scale	Extension	Contour Interval (ft.)	Reference No. (example)
Million Sheet or 1M Sheet	1:1000,000	4°×4°	500	72
Degree Sheet or Quarter-inch Sheet	1:250,000	1°×1°	100	72F
Quadrant or Half-degree or Half-inch Sheet	1:100,000	30'×30'	50	72 F/NE
15' Sheet	1:50,000	15'×15'	20	72 F/10
Special Sheets	1:25,000	5'×7.30" 7.30'×7.30'	10 10	72 F/10/5@ 72 F/10NE#

Note: @—Old Layout before 1990; #—New Layout since 1990.

1.5.1.2 Open Series Maps

Table 3: Layout of OSMs (NMP 2005, Projection-UTM, Datum-WGS 84)

Name	Scale	Extension	Reference No. (example)
Million Sheet	1:1000,000	6°×4°	F45
Degree Sheet	1:250,000	1°×1°	F45 D
15' Sheet	1:50,000	15'×15'	F45 D 08
Quadrant Sheet	1:25,000	7.30'×7.30'	F45 D 08 NW
3' Sheet	1:10,000	3'×3'	F45 D 08 U
LS Sheet	1:2,000	36'×36'	F45 D 08 U 13

The scientific principles of surveying have since been enhanced by the latest technology (RS and GIS) to meet the multidisciplinary needs of national security,

1.5.2 Dimensions

Fig. 8 Indian Topographical Map: Dimension and Scale

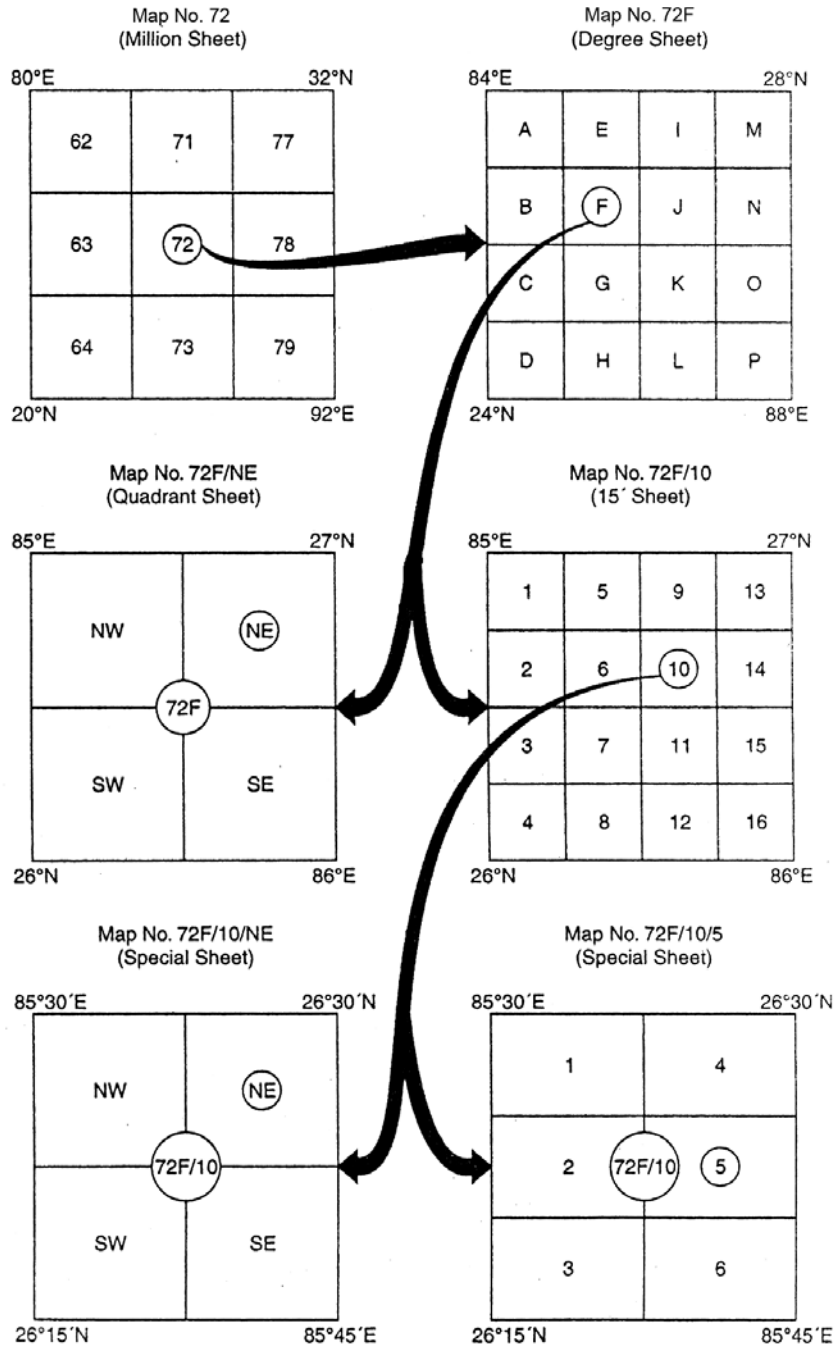

sustainable national development, and new information markets. The SOI has taken a leadership role in providing the user focused, cost effective, reliable and quality geospatial data, information and quality geospatial data, information and intelligence by introducing a new national map policy (NMP) on 19 May 2005 that reshapes altogether the long existing frame of mapping layout, scheme of map referencing, scale and dimension of mapping, nature of map product and finally, their mode of access. The SOI promotes an active exchange of information, ideas and technological innovations among the data producers and users across the globe, who get access to such data of the highest possible resolution at an affordable cost in the real-time environment. It will produce two different series of maps, such as, *Defence Series Maps* (DSMs) and *Open Series Maps* (OSMs).

The DSMs are topographical maps (on Everest/WGS-84 Datum and Polyconic/UTM Projection) on various scales (with heights, contours and full content without dilution of accuracy) to cater only for defence and national security requirements. The OSMs, on the other hand, are primarily for supporting development activities in the country. These are drawn on UTM Projection on WGS-84 datum. Each of these OSMs (in both hard copy and digital form) with complete topographical database will become “unrestricted” after obtaining a one-time clearance from the Ministry of Defence. The SOI will ensure that no civil and military vulnerable areas and vulnerable points (Vas/VPs) are shown on the OSMs.

In this layout, India is covered by 32 UTM zones of ($6^{\circ} \times 4^{\circ}$) dimension (i.e, B46, C42, C43, C44, C46, D42, D43, D44, D46, E43, E44, E45, F42, F43, F44, F45,, F46, G42, G43, G44, G45, G46, G47, H42, H43, H44, H45, H46, H47, I43, I44, and J43). These are drawn on 1:1,000,000 scale and are called *million sheets*. Each million sheet contains 34 *degree sheets* on 1:250,000 scale and are designated by *alphabets*, A-X. Each degree sheet contains 16 sheets of ($15' \times 15'$) dimension on 1:50,000 scale and are designated by *numerals* 01–16. A 15' sheet is then divided in *two ways*. *Firstly*, each sheet contains 4 *quadrant sheets* of dimension ($7'30'' \times 7'30''$) on 1:25,000 scale and are designated as NW, NE, SE and SW, *Secondly*, each sheet contains 25 sheets of dimension ($3' \times 3'$) on 1:10000 scale and are designated again by alphabets, A–Y. Each 3' Sheet contains 25 sheets of ($36'' \times 36''$) dimension on 1:2000 scale and are designated again by numerals, 01–25. These are the largest scale maps published by the SOI (even larger than the existing cadastral maps on 1:4000) and are called LS sheets.

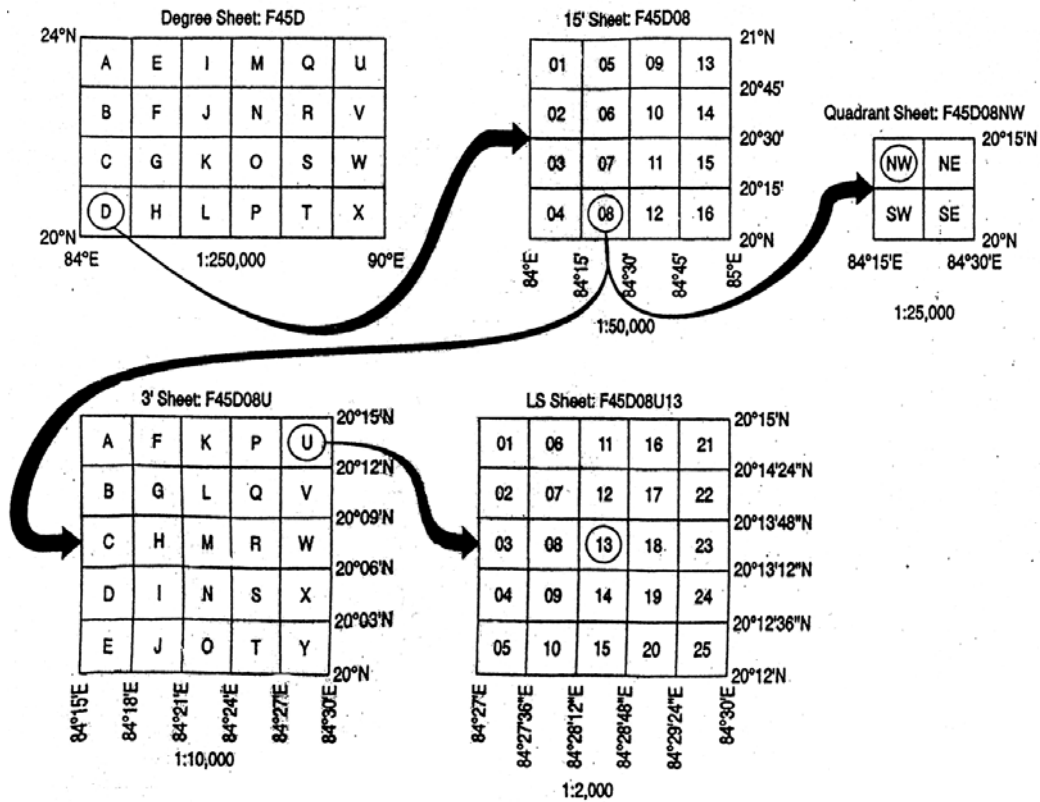

Fig 9: Open Scales Map: Dimension and Scale

1.6 Methods of Interpretation

After the identity of the toposheet is established, its interpretation follows. It requires a careful study of the marginal information and the body of the map. A preconceived textbook knowledge about the characteristics origin, patterns and associated processes of the major map elements (i.e., geology, geomorphology, phytogeography, settlement geography, cultural geography, economic geography, etc.) as well as sound idea of the region portrayed in the map is required. Toposheet interpretation is a 3-step process by which features of the elements are first identified, followed by a recognition of the patterns produced by the features and finally an explanation of the patterns in terms of the processes involved (**Table 4**).

Table 4: Identification of Features on Topographical Sheets

Elements	Symbols/Criteria	Features
Relief	Contour pattern, spacing and values Conventional symbols Letter symbols	Hills of various elevation, shape and size; valleys of various shape, size, length and gradient; ridges of various geometric outline; basin; col; saddle; spur; cliff; escarpment; gorge; slope form; water divide; different types of pataeus and plains; etc. Dune; etc. Rock outcrop; stony waste; rock; etc.
Drainage	Line symbols and associated pattern Conventional symbols Letter symbols Understanding the associated features	Drainage patterns (dendritic, pinnate, parallel, rectangular, radial, annular, angulate, barbed, deranged, contoured, etc); channel patterns (straight, sinuous, meandering, anabranching, braided, etc); perennial and non-perennial channels; dry bed; canal; abandoned channel; crevasse splay; meander scroll; cut off; etc. Shoal; island; sand deposit; rocky bed; boulder bed; gully erosion; waterfall; swamp; etc. Barrage; reservoir; ford; ferry; seasonally inundated areas; etc. Terrace; river capture; meander core; paleo channel; Alluvial fan; hydrological aspects; etc.
Vegetation	Letter and conventional symbols Understanding the associated features	Reserve forest; protected forest; scrubland; grassland; jungle type; specials type; species density; plantations; orchards and groves; horticulture; silviculture; etc. Afforestation; deforestation; etc.
Settlement	Conventional symbols Spatial distributrion Geometry of shape	Deserted village; fort; walled settlement; tribal settlement; etc. Hamlet; isolated pattern; dispersed pattern; clustered pattern; random pattern Square; rectangular; circular; semi-

Elements	Symbols/Criteria	Features
	Judging sites	circular; liner; A, L, T, Y shaped settlement; amorphous; etc. River bank; wet point; dry point; piedmont; confluence; forest fringe; gap; summit; leaves; etc.
	Judging symbols (letter and conventional) and associated features	Rural settlement; urban centre; planned town; agricultural, mining, industrial, administrative, religious places or settlements; new settlement; colony; etc.
Transport and Communication	Line-symbols	Road (metalled, unmetalled and village), highway (state and national); railway (narrow, broad or metre gauge, division, etc.); mineral line; telegraph line; power line; etc.
	Letter symbols	Waterway; ford; ferry; etc.
	Conventional symbols	Aerodrome or airport, bridge etc.

1.6.1 Identified Physical Feature

Some mentionable physical features identified from the given topographical sheet no.73^A/₁ are:

Conical Hill : A very common physical features is conical hills which can be easily identified by contours which are circular in pattern with high values towards the centres. These conical hills are associated with radial drainage pattern. A prominent example occurs in the eastern part in Grid near Betla Reserve Forest, the Palamou Pahar. Other examples are Banila Pahar, Chindal Pahar in B₂ Grid. These conical hills are formed from elongated ridges after going through fluvial dissection and these hills are around 300m in elevation.

Ridge: Another prominent physical features is elongated ridge. Such elongated ridge can be found in the western part in A₂ grid near the protected part the Begh Pahari Region. It acts as a water divide. These ridges are well dissected and nearly above 400m and are parabolic in nature with a number of ridges in between.

Cliff: Dissection of river has produced some typical landform like cliffs eg. in the south-central part in B₃ grid.

Falls: We can also find some falls in the map. There are many falls of average 10m height. This is a kind of geomorphic feature is found at the upper course of any river.

Identified Physical Feature

[Related to the Activities of Rivers]

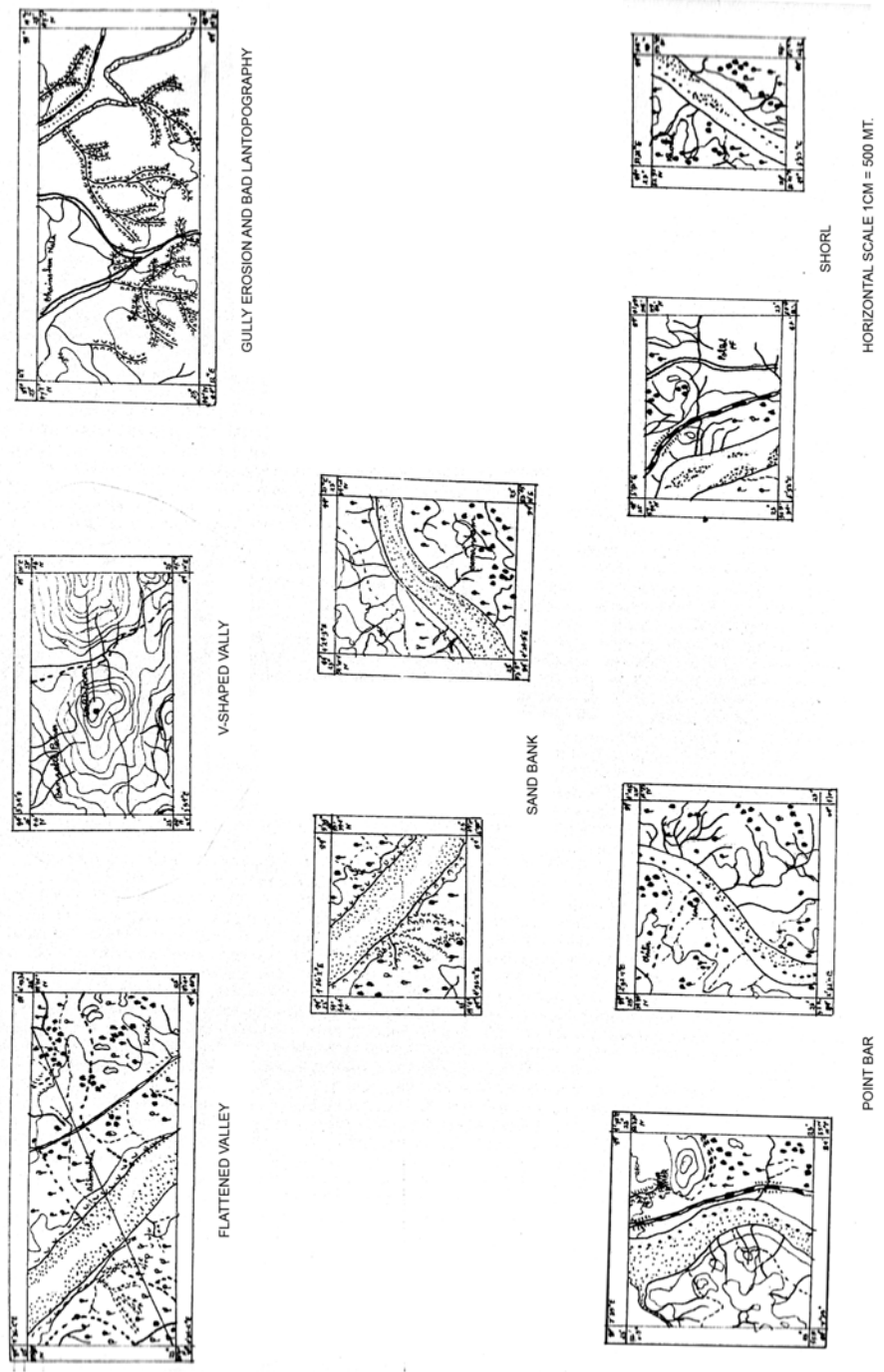

Fig.: 10

1.6.2(A) Miniature map

MINIATURE MAP BIHAR

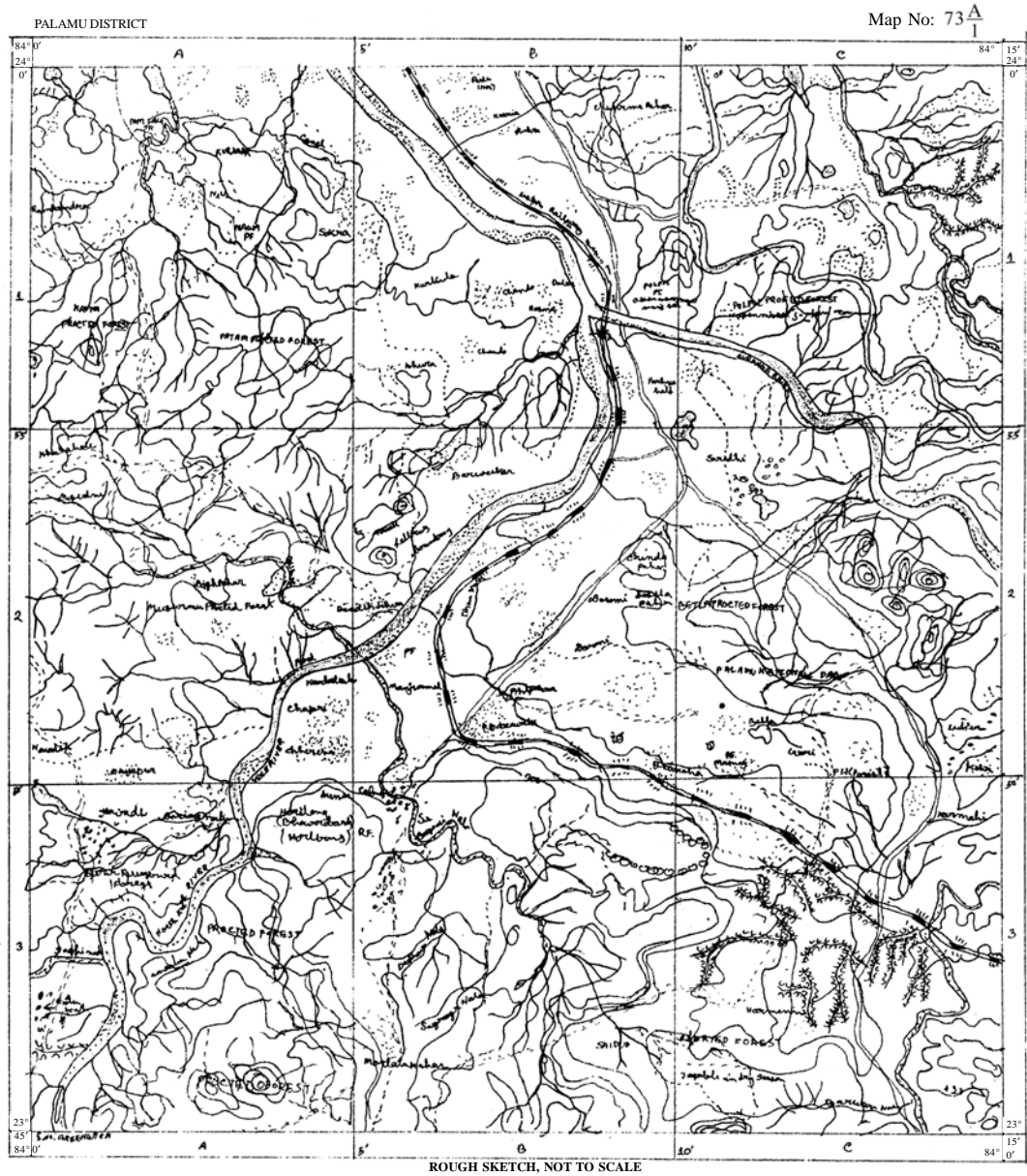
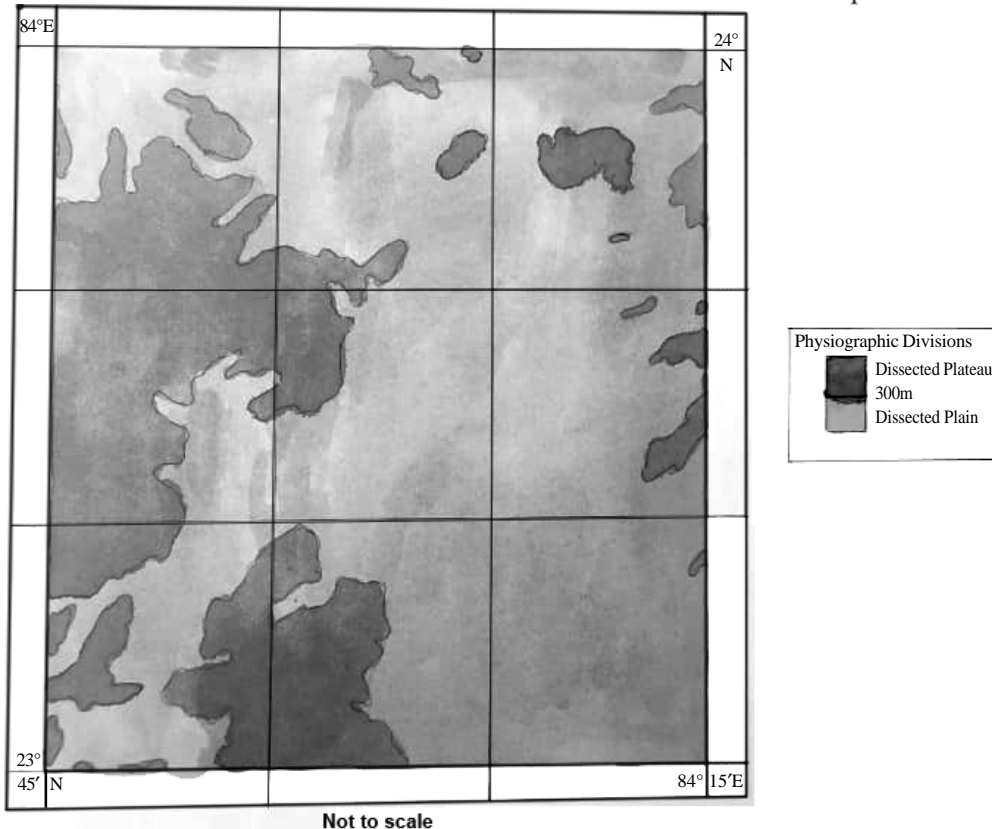

Fig.: 11

BROAD PHYSIOGRAPHIC DIVISIONS
BROAD PHYSIOGRAPHIC DIVISION
(BIHAR)

Palamu District

Map No: 73 ^A/₁



Introduction : The sheet no of the topographical map is 73^A/₁. It represents part of Palamu district of Bihar. The scale of the map is 1:50,000 that is 20m on the map represents 1 km on ground. The contour interval is 20m. The map is surveyed in 1979-1980. The region extends from 23°45' N to 24' and 84°E & 84°15' E.

Physiographic Divisions : The region is dissected plateau area by North Koel river and its tributaries with isolated ridges and conical hills. The ridges are elongated and flat topped. The elevation varies between 240m to 500m. Obvesing the flowing direction of the main river North Koel, it can be said that its general slope of the region is from south-west towards north.

The region can be divided in two broad physiographic divisions.

Dissected Plateau: The first physiographic division or zone is the dissected higher plateau region which is above 300 m. This zone can be seen in western, south-western and partly in eastern part of the map. The highest elevation is 500 m near Baduentani. Many Pahars are also around 500 m like Lahara Pahar (498 m), Ranimai Pahar (464 m), Budhubean Pahar (587 m) etc. The hills are separated by valleys. The region is generally inaccessible occupied by the dense mixed jungle, reserved forest, mainly sal.

Dissected plain: The second physiographic zone is dissected plain region with elevation below 300 mt. It is found in the rest part of the map along with the main river. Mainly norther, north-eastern and central part of the region and also in isolated patches in south-eastern part. The physiographic unit is confined along the large valley of North Koel river and Anunaga river and the interflares of Jungle, Khuli, Denis, Crobours Nala. We can also find a badland in extreme southern region.

Slope of Physiographic Division:

First Zone : The average slope is more than 15° and the relative relief of this zone varies between 150 m to above 200 m.

Second Zone: The average slope varies between 5° - 15° , where this zone borders the high dissected regions the slope angle relatively higher. The relative relief various between 50 m to 150 m.

Third Zone: The last physiographic division has an elevation between 140 m to 200 m and this zone is observed adjoining the river and located on the south-eastern, northern, western part of the area. The lower part of the Khalkalia Nala, Champal Nadi and Karandi ghar fall in this physiographic divisions. This zone is having gently undulating almost flat terrain with relative relief below 50 m. The average slope is below 5° . This areas shows widely spaced contour and relatively large 3rd or 4th order streams. This area's probably flat undulating nature due to fluvial planation.

Some typical physiographic feature were identified from the given topographical sheet. The most permanent occurrence to steep sided escarp can be seen in the south-eastern corner of the area near Jal Reserved Forest, here the ridge gently ascends from the northern part but descends towards the south with almost vertical fall. Similar ridges with lesser magnitude can be seen in number of other areas mostly in the north-western part of the region near Landakat Reserved Forest area. Such steep sided ridges are the characteristics of the rightly dissected elevated region, The ridges are mostly seen about above 300m.

Another very common physical features is the conical hill which can be easily identified by the occurrence of concentric contours with higher value to the centre. In this conical hill, radial drainage pattern is very prominent example occurred in the W-N-W. Another such conical hill is located in the south-eastern corner of Angrid near Rampur Reserved Forest. However, it is observed that there are the elongated ridges have undergone fluvial dissection, they have remained as isolated conical hill which are more than 80-100m in elevation. The steep sides elongated ridges are located in the northern and eastern part of the region. These ridges are narrow created, highly dissected by large number of 1st order stream with very high slope and this act as water divide in between drainage basins. Isolated hills mostly conical are observed adjoining the river and mostly in the second physiographic zone. This is occur probably by the result of fluvial direction. The concave valley slope with clearly spaced contours at higher elevation and widely spaced contours at lower elevation are noted on the western part of the region. A cross section is drawn along line AB in the typical features clearly shows the nature of the slope. Such slope characters are seen in another part of the area where the steep ridges gradually dissend towards the meander rivers. The small tributaries joining the main stream shows a very steep profile in the upper part and a gently slope in the lower part as they join the main stream. In such plain-plateau margine, concave slope is a common pattern.

1.6.3 Representative Profile or Longitudinal Profile

Representative profile is used to identify breaks in slopes, summit levels, general nature of the dissections and also to understand the fluvial morphology.

In the topographical sheet no. 73A/1, a longitudinal profile / representative profile has been drawn on the line AB. It is in grid C3. The location of the point A is $23^{\circ}45'4''$ N and $84^{\circ}10'38''$ E and the location of point B is $25^{\circ}48'26''$ N and $84^{\circ}13'20''$.

The highest elevation is 580 m and the lowest elevation is 240 m. Scale has been considered as vertical scale $1\text{ cm} \cong 100\text{ m}$ and horizontal scale $1\text{ cm} \cong 500\text{ m}$.

REPRESENTATIVE PROFILE OR LONGITUDINAL PROFILE

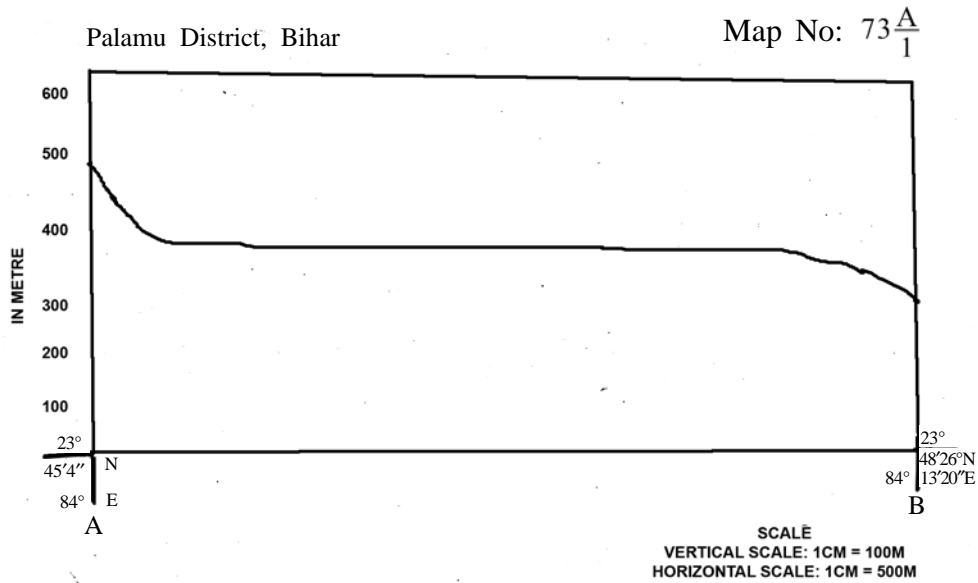

Importance:

- 1) It is important to analyse the relief of the area.
- 2) It helps to construct a clear picture about the break of slope of an area.
- 3) It gives a overall view and idea of the local relief features.

Procedure: This profile is drawn with the procedure mentioned below:

- 1) It is drawn with the help of highest and lowest altitude of the area. Therefore, a line is drawn joining the highest and lowest altitude of the area.
- 2) The entire cross section is based on this line.
- 3) Thereafter, the nature of slope, break of slope is to be identified with the help of such profile.

1.6.4 Serial Profiles

Serial profile of any topographical map is done to get a view of the relief in a serial wise manner. It bring to us the sequital view on fall of altitude in an area in an orderly manner. By opting this method, we can study the phase of development of the relief in a given region.

SERIAL PROFILES

Map No: 73^A/₁

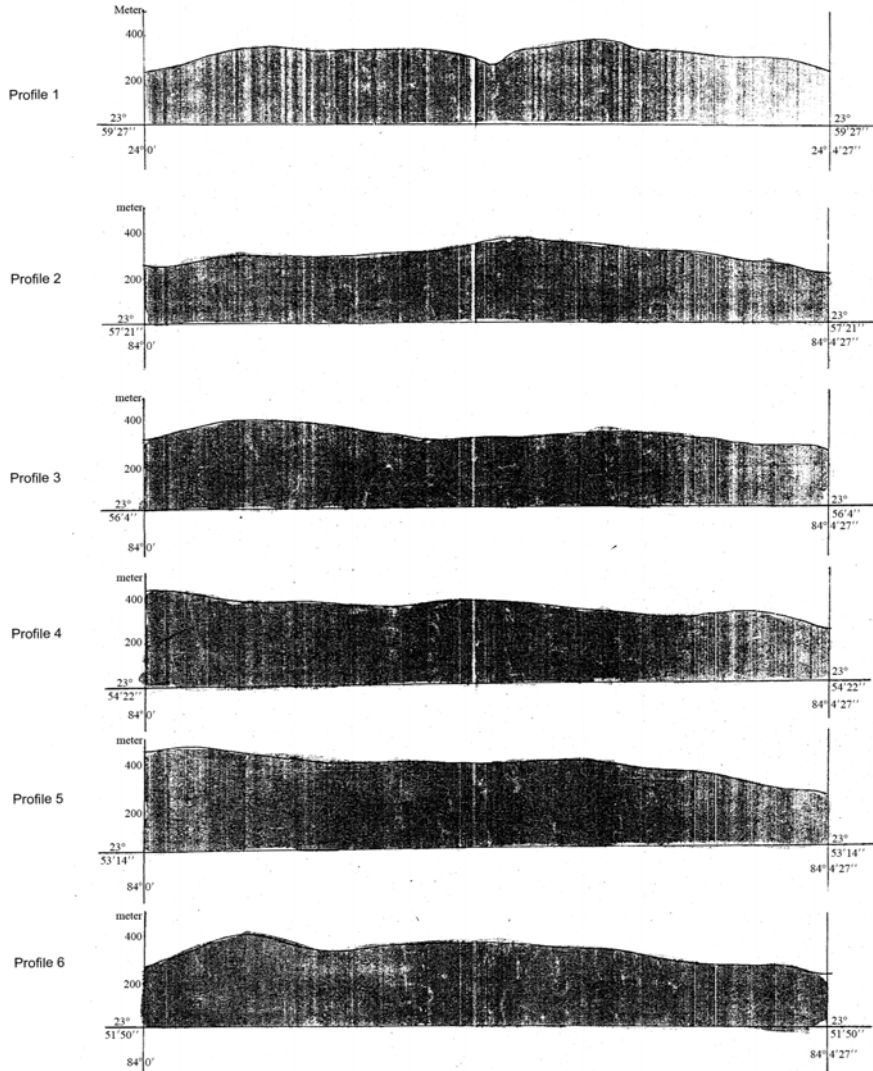

VIEW FROM NORTH

SCALE
 VERTICAL SCALE : 1cm ≅ 200m
 HORIZONTAL SCALE : 1cm ≅ 500m

In the given diagram, we get a glimpses of six serial profiles arranged in an orderly manner accounting to their altitude longitudinal and latitudinal variations. Generally a serial profile is viewed from the south to view the sequential increase in the height of an area. But the given topographical map number 73A/1 having a lower relief towards north.

In profile number one, we see a low relief. Having proximity to the main river (North Koel river), this profile is relatively low having longitudinal extension from $84^{\circ}0' E$ to $84^{\circ}4'27'' E$ and logitudinal value of $23^{\circ}27' N$.

In the second profile, we see a comparatively higher relief than no one with the same longitudinal extension of $84^{\circ}0' E$ to $84^{\circ}4'27'' E$ and longitudinally value of $23^{\circ}57'21'' N$.

The following profiles are drawn in the same manner. We can observe the gradual increase of relief and altitude from profile one upto profile six.

Profile no. three has the same longitudinal extension as one and two with the latitudinal value being $23^{\circ}86'4'' N$.

All the profile have the same longitudinal extension but they differ in their latitudinal values.

Profile number 4—Latitude $23^{\circ}54'22'' N$

Profile number 5—Latitude $23^{\circ}53'14'' N$

Profile number 6—Latitude $28^{\circ}51'50'' N$

1.6.5 Superimposed, Projected, Composite Profile: Concept:

Superimposed Profile: Plotting of a set of serial profile covering on area on a single frame with common axes, gives the *Superimposed Profile*. It represents the true character of the landform.

Projected Profile: From the Superimposition of many lines in a single frame consequently one after another starting from the first profile, a kind of panoramic sketch is produced, known as *Projected Profile*. It gives a panoramic effects of landforms.

Composite Profile: Tracing only the supermost line from a diagram of super-

SUPERIMPOSED PROFILE

MAP NO: 73^A/₁

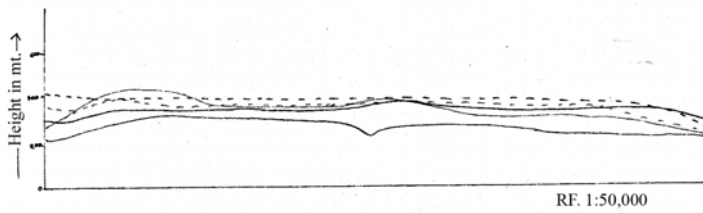

PROJECTED PROFILE

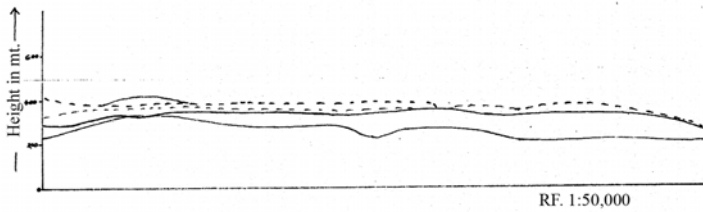

COMPOSITE PROFILE

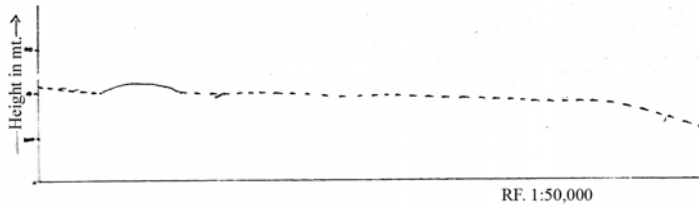

INDEX

PROFILE 1	—
PROFILE 2	—
PROFILE 3	- - -
PROFILE 4	- - -
PROFILE 5	- - -
PROFILE 6	- - -

SCALE

VERTICAL SCALE : 1 cm \cong 200m
 HORIZONTAL SCALE : 1cm \cong 500m

[Note : Use different colours or symbolic line to draw the profiles]

imposed or projected profile in the similar frame produces a *Composite Profile*. It represents the summit levels or skyline of landforms.

Now we use the individual profiles from the serial profiles and draw them, one apart the other. This diagram is called **Superimposed profile**. It's a method of comparing the relative heights of subsequent reliefs.

The lines of different colours represents six different profile, like—

Brown solid line represents profile 1

Black solid line represents profile 2

Brown dotted line represents profile 3

Black dotted line represents profile 4

Red dotted line represents profile 5

Red solid line represents profile 6

The diagram of the **Projected profile** can be mentioned as a result of the prior one. We draw it by looking at the superimposed profile. Here lines do not cut each other. We only draw it with the estimation of how much the profiles could be seen one after the other.

In case of the **Composite profile**, diagram, we only join the skyline of the earlier drawn profiles. It does not show all the profiles. In the composite profile diagram profile no. 4 could be seen maximum. So we can say that, it has the maximum relief of the region. The other profile which could be seen are profile no. 2, and 6. Profiles 1, 3 and 5 not seen because of their quite low height.

Unit 2 □ Relative Relief map, Slope map (Wentworth)

Structure

2.1 Relative Relief

2.2 Average Slope

2.1 Relative Relief

G. H. Smith in 1935, first used the term relative relief or local relief analysis. Smith used the method to make an analysis of the surface of Ohio state. In this method an area or map is divided into 2 cm by 2 cm grids. He calculated the difference of altitudes between the highest and lowest points of each square or the base map. Isopleths are drawn thereafter to indicate areas with same local relief value. The resulting map brings out areas of high relative relief and low relative relief. This map is also a type of slope map.

Relief is the difference between the high and low heights of a given map area. It shows the physical out line of the land surface. Relative relief is also known as the amplitude of relief found in an area. To find the difference between map and main height of an area into topographical sheet, we divided the area into a grid and write it in the center of the grid and find the relief of each grid. The relief is drawn according to the convenience and then lines are interpolated to make groups prominently. The difference of a relief groups are shaded and explained by the index in the margins.

Formula: Highest altitude—Lowest altitude
(per grid of 2 cm by 2 cm)

CALCULATION TABLE FOR RELATIVE RELIEF [MAP NO. 73^C/8]:

Sl. No.	Grid Number	Maximum Height (mt.)	Minimum Height (mt.)	Relative Relief (mt.)
1.	A ₁	340	220	120
2.	A ₂	420	220	200
3.	A ₃	220	200	20
4.	A ₄	200	180	20

Sl. No.	Grid Number	Maximum Height (mt.)	Minimum Height (mt.)	Relative Relief (mt.)
5.	A ₅	190	180	10
6.	A ₆	180	160	20
7.	B ₁	549	260	289
8.	B ₂	470	240	230
9.	B ₃	300	220	80
10.	B ₄	200	200	220
11.	B ₅	200	180	20
12.	B ₆	—	—	20
13.	C ₁	520	240	280
14.	C ₂	440	240	200
15.	C ₃	240	220	20
16.	C ₄	220	200	20
17.	C ₅	301	180	121
18.	C ₆	180	80	120
19.	D ₁	420	240	180
20.	D ₂	400	240	160
21.	D ₃	220	200	20
22.	D ₄	220	200	20
23.	D ₅	180	140	40
24.	D ₆	420	400	20
25.	E ₁	400	300	100
26.	E ₂	220	140	60
27.	E ₃	200	130	70
28.	E ₄	220	140	60
29.	E ₅	200	180	20
30.	E ₆	180	180	20

RELATIVE RELIEF MAP (AFTER SMITH)

DHENKANAL AND SAMBALPUR DISTRICTS, ORISSA

MAP NO: 73^c/₈

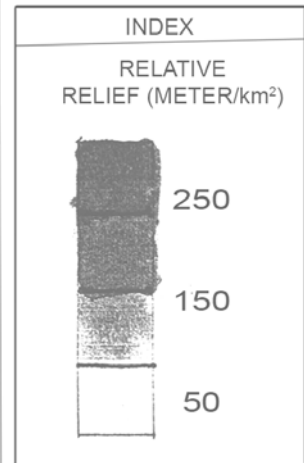
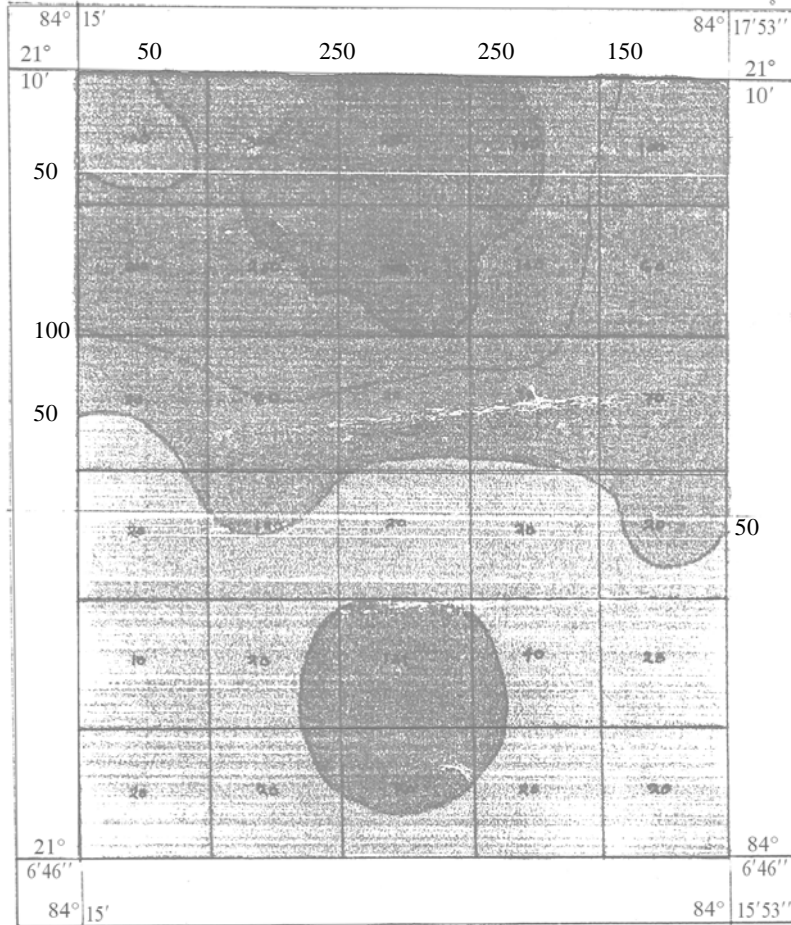

R.F. 1:50,000

Relief of the map 73^C/8:

The given topographical map 73^C/8 represents a part of Dhenkanal and Sambalpur district of Orissa. The scale of the map is 1:50,000 that is 2 cm on the map represents 1 km on the ground. The contour interval is 20 m. The map is surveyed in 1979-1980. The region extends from 21°N to 21°50'N and from 84°15'E - 84°30'E.

The region is a fluvially dissected plateau area with isolated ridge, small conical hills and escarpments. The ridges are enlarged and narrow sharp events are also visible at same locations. The elevation varies between 120m - 538m observing the direction of flow of the main river, it can be said that general slope of the area is predominantly from north and south, but a secondary slope component is also seen in the north-eastern part of the region.

The region can be divided into three broad physiographic divisions according to the physiographic section drawn by the highest to lowest elevation in the map, there it may be noted that the highest elevation in the map is located at the Sadophar (438). But the representative profile has been drawn from Panchudia Pahar (554m). This was taken because the features of Panchudia Pahar more or less similar to that of Sado, Pahar and the length of the profile was more manageable.

Interpretation of Relative Relief [Map No. 73^C/8]

The relative relief map has been drawn with the help of absolute relief of the Topo Map No. 73^C/8. It represents four zones of relief with the value ranges <50 m, 50–150m, 150–250m and >250m in elevation. The highest value zones, i.e. hilly tract and plateau are in the northern part whereas the lower zones i.e. dissected plain is found in the southern portion in the relative relief map. An isolated hill (like monadnock) exists in the dissected plain area.

RELATIVE RELIEF MAP (AFTER SMITH)

Map No: 73 $\frac{A}{1}$

PALAMU DISTRICT, BIHAR

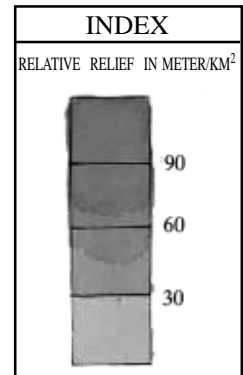
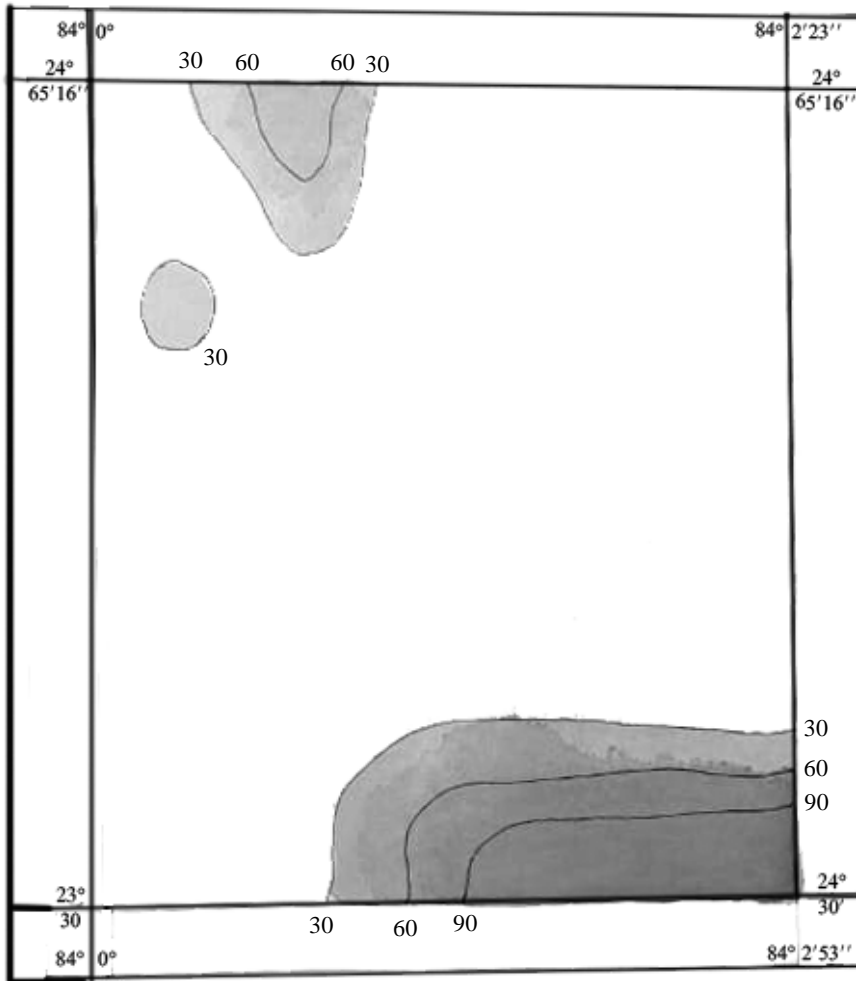

R.F. 1:50,000

INTERPRETATION OF RELATIVE RELIEF

(MAP NO. 73^A/1)

The topographical sheet having the no. 73^A/1 covers part of Palamu district of Bihar state. The area is chosen to show the relative relief of particular portion of the map 73^A/1 which represents both hilly tract and dissected plain. Latitudinally the selected area extends from 23°50' N to 23°53'16" N. Longitudinally the selected area extends from 84°0'E to 84°2'53"E. The selected area is about 30 sq. km of area. The highest elevation is found at Ranimal Pahar (464m). On the other hand lowest elevation is 280m. The region has low relative relief in the hilly and plateau. It means this is a plateau top area where relative relief remains low. Some portion of the area has high relative relief, although absolute altitude is lesser in these portion. It means towards with dissected plateau, plain exists where ups and down of relief is very high.

2.2 Average Slope:

C. K. Wentworth, first used average slope. According to him, it is the gradient i.e. the ratio of vertical to horizontal equivalents which is expressed in British Units (F.P.S.).

Formula: $\tan \theta = \frac{\text{Number of contour crossing per sq.km} \times \text{Contour Interval}}{1000 \times 0.6366}$

(1000 × 0.6366 = 636.6 is the constant value)

[In case of maps with metric units where distance is expressed in km and the contour interval in metres on in topo sheet of R.F. 1:50,000]

Procedure: In the drawing of average slope map of an area is in the initial stage by dividing the area into a number of square grids. Now the number of contour crossing is counted along the grid perimeter and the average number of contour crossing per unit distance is worked out which after manipulation with the contour interval provides this vertical interval. The horizontal equivalents is the linear, distance of 1 km, is converted to equivalents 1000 units. It is then multiplied by an constant 0.6366 which is the mean of all possible values of sinθ where, θ is the horizontal angle between the contour interval and the grid line. Therefore, the single process of counting with core, the number of contour crossing timely represents the area under consideration.

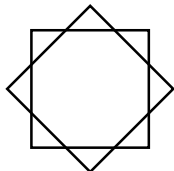

1km × 1km = 1 Square km

Two square—One straight and the other diagonal. The two values must be considered for getting average value. (Like : i) 8° & ii) 9°, average value = 8°30')

This slope map is essential as it will determine the flow:— i) runoff ii) direction of stream iii) value will through light on—how the land can be utilized? etc.

CALCULATION FOR AVERAGE SLOPE (MAP NO. 73^A/1)

Sl. No.	Grid Number	Total Contour Crossing	Contour Crossing Per sq. km(N)	Contour Interval(s)	Constant (h)	Average Slope (in degree)
1.	A ₁	13	3.25	20 mt	636.6	5°49'47.92"
2.	A ₂	5	1.25			2°14'56.09"
3.	A ₃	13	3.25			5°49'47.32"
4.	A ₄	23	5.75			10°14'23.59"
5.	A ₅	16	4			7°9'45.63"
6.	A ₆	8	2			3°45'43.39"
7.	B ₁	10	2.25			4°29'27.31"
8.	B ₂	11	2.75			4°56'16.41"
9.	B ₃	19	4.75			8°29'15.47"
10.	B ₄	23	5.75			10°14'23.59"
11.	B ₅	17	4.25			7°36'18'32"
12.	B ₆	6	1.50			4°29'27.31"
13.	C ₁	7	1.75			3°8'48.35"
14.	C ₂	24	6			10°40'30.26"
15.	C ₃	15	3.75			6°43'3.25"
16.	C ₄	21	5.25			9°21'57.45"
17.	C ₅	17	4.25			7°36'18.32"
18.	C ₆	4	1.50			1°47'58.07"
19.	D ₁	15	1.75			6°43'09.23"
20.	D ₂	43	6			15°1'10"
21.	D ₃	17	3.75			7°36'13.32"
22.	D ₄	14	5.25			6°16'23-93"
23.	D ₅	17	4.25			7°36'13-32"
24.	D ₆	10	1			4°2'36.24"
25.	E ₁	21	3.75			9°21'57.48"
26.	E ₂	30	3.6			13°15'30.88"
27.	E ₃	30	4.25			13°15'30.88"
28.	E ₄	13	3.25			5°49'47.92"
29.	E ₅	13	3.23			5°49'47.92"
30.	E ₆	14	3.5			6°16'29.95"

AVERAGE SLOPE MAP (AFTER WENTWORTH)

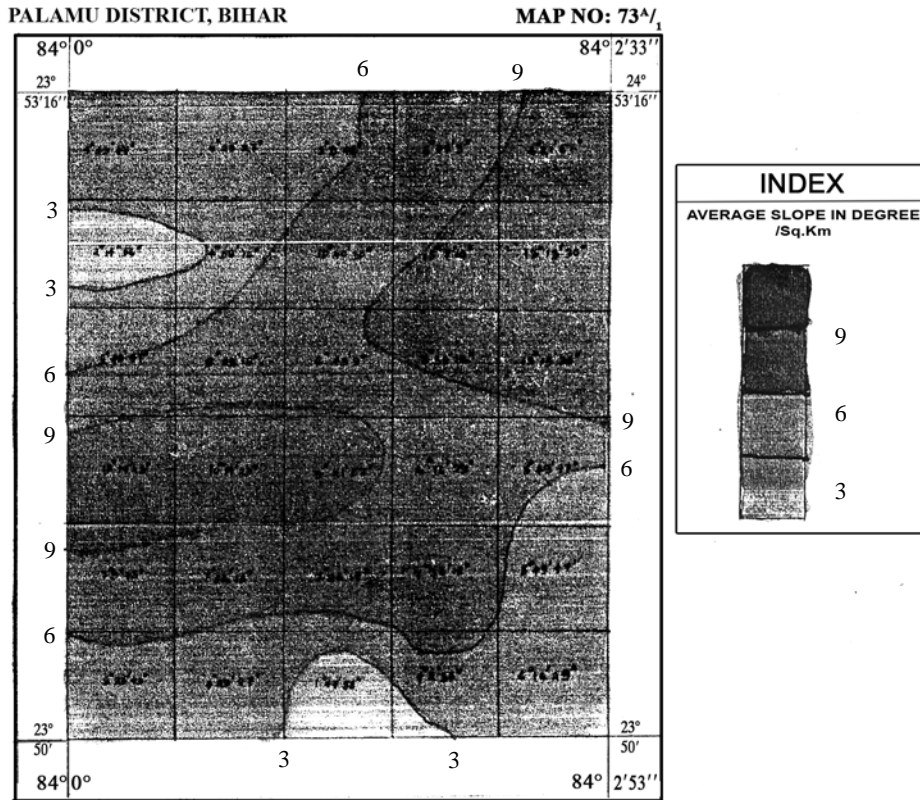

R.F. 1:50,000

INTERPRETATION OF AVERAGE SLOPE (MAP NO. 73^A/₁)

The topographical sheet bearing the no. 73^A/₁ covers part of Palamu district of Bihar state. The area chosen to show the average slope of a particular portion of 73^A/₁ to represent both hilly tract and dissected plain. Latitudinally the selected area extends from 23°50'N to 23°53'16"N and longitudinally the selected area extends from 84°0'E to 84°2'53"E. The selected area covers about 30 sq. km of area. The highest slope is about 13°15' and lowest slope is about 1°14'. In the average slope map three isolines have been drawn at 3° interval. The value of the isolines are 3°, 6°, 9°. The whole part and the north-eastern and west-central part have highest slopes. The medium slope areas are found in central and north-eastern part. Towards south-east and north-west lower slopes are found. It has been found that the dissected plain area's slopes are lower, on the other hand, the plateau and hilly area's slopes are higher by value.

Unit 3 □ Correlation between physical and cultural features from topographical map

Structure

3.1 Drainage

3.2 Drainage Pattern

3.3 Drainage Density

3.4 Relative Relief, Stream Frequency and Drainage Density of a common area

3.5 Vegetation Map

3.7 Settlement and Communication Map

3.7 Transect Chart: Correlation between physical and cultural features

3.8 Interpretation of Topographical maps according to questions:

3.8.1 Example 1

3.8.2 Example 2

3.1 Drainage

The streams in the region are all non-perennial and there is no single stream which dominates the region. Most of the major streams generally flow from North to South and North-West. It gives an idea about the regional slope of the area. One relatively large stream flow from west to north. This is the Chempal nala seen in the extreme north-eastern part of the map. The river shows a typical dendritic drainage pattern and meander have formed in it. In this region, the topography is relatively gentle and the relative relief is more than 40-60 mt. Hence the river covers conical hill, concave and convex slope, escarpment, spur, dome etc.

In the lower portion, the river exhibits formation of sand bars and heavily silt, probably the material has been brought down from the surrounding plateau fringes. In the western part of the region, the drainage is dominated by the Khalkhalia nala and its tributaries. The Khalkhalia nala has a long course through the dissected plateau surface but it does not have the meander in its upper ridge. The main tributary of the river is Telkani nala which joins Khalkhalia nala in west of village. After this confluence the combined flow is known as Surbali jhar. Peculiarly the Khalkhalia nala has no major left bank tributary but the tributaries in the right bank are the relatively longer. All the tributary show dendritic drainage pattern in their upper ridges, but if we consider the 1st order stream from radial drainage pattern in their ridges, originating

from the steep sided conical hills which have formed after dissection of the plateau surface. The central part of the ridge region is dominated by the river karandi and its tributaries. This non-perennial river originates from the relatively high plateau summits near panchmurida pahar (554 mt). The river is initially join by 2nd or 3rd order streams after has formed more or less straight on sightly sinuous course. Just after the village Bijaypur, the river is joined by major left bank tributary. The Khanda

DRAINAGE MAP BIHAR

Map No: 73 $\frac{A}{1}$

PALAMU DISTRICT

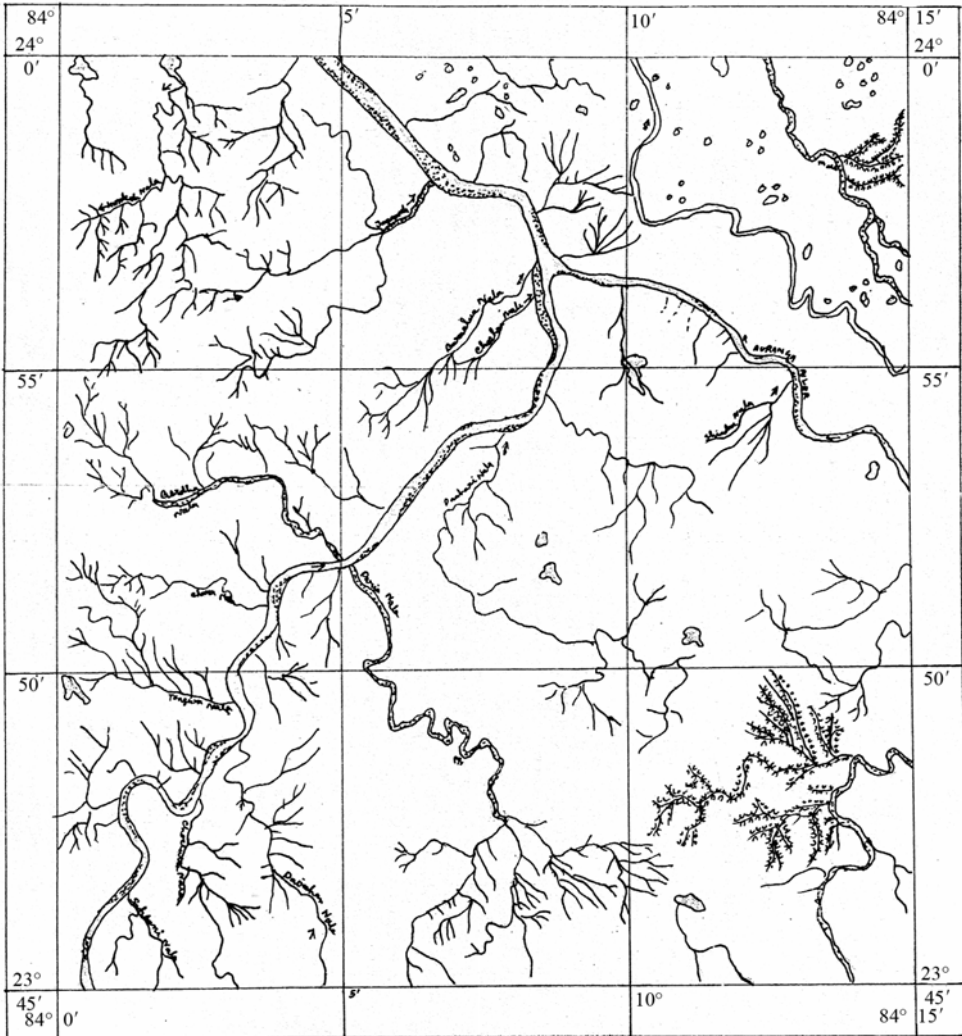

NOT TO SCALE

Jhar river is itself joined by two major tributary one from left bank has long east to west course. The Khanda Jhar right bank tributary has formed well developed meandering bends to its south most point of the region. The whole river shows heavy silt deposition along its sediment depositions. This may be because both the Daineha nala and Khanda Jhar. The Daineha nala have long courses over the plateau surface and hence the most of the amount of eroded material must be substantial.

3.2 Drainage Patterns

Different drainage patterns, clearly indicate different or diverse geologic structure and the influence of slope, climate, soil, vegetation. Moreover, straight, irregular, sinuous and meander drainage patterns have diverse explanation.

A drainage, especially channel pattern is called *straight* when there is no bends and it indicate, structural weak zone. An *irregular* pattern is bending river. A *sinuous* pattern has a symmetrical bends. The bends of a symmetrical drainage is *meandering* channel. A *braided* pattern resembling a braid with certain amount of widening of the channel, to accomodate the extra load of silt and water, develops when number of bifurcation of the flow occurs.

IDENTIFIED DRAINAGE PATTERN

The sheet number of the given topographical map is 73^A/1. It represents part of Plateau district of Bihar. The scale of the map is 1:50,000 that is 2 cm on the map represents 1 km on the ground. Here the contour interval is 20m. The region extend from 23°45'N to 24°N and from 84°E to 24°15'E.

The region is a dissected plateau and formed by North Koel river and its tributaries with isolated ridge and conical hills. The varying underlying geological structure, surface, morphometry and stage of evolution together have given rise to a variety of drainage and channel patterns. The most common of these, is the dendritic pattern in which the alignments of the tributaries and subtributaries are along to the branching arrangement of a tree. The dendritic pattern associated with the areas of homogeneous lithologies, horizontal or very gentle dipping strata and extensive topographic surface having extremely low relief. Here in these map, there are numerous dendritic pattern like A₂ Grid near the Charhat settlement, B₂ grid near the Barichater etc and so on.

However, locally rain areas with broadly identical slope conditions, the network

of tributaries have formed parallel pattern mainly in ridge area. It comprises numerous rivers, which are parallel to each other and follow the regional slope. This pattern is more frequently develop on uniformly sloping and dipping rock beds such as valley or changed coastal plain. Here in this map, there are numerous parallel drainage pattern.

The another pattern comes as radial drainage pattern which is also know as centrifugal pattern. It is formed by the stream which diverge from a central higher point in all directions. It is dome surface, volcanies cones, batholiths and lacoliths residual hills, small table lands, messa and butte and isolated upland favoured the development of that radial pattern. In map, there are mumermors radial drainage pattern, near Talyahi pahar, A₃ grid near Tular RF, A₂ grid near Musmin Reserved forest etc.

Lastly comes the water bodies which is very important for the settlements. If we go through the map, we can see that various settlement patterns are found near waterbodies which is used for agricultural purpose. Here we have found water bodies near Nagpur Noudhi settlement.

3.3 Drainage Density

Drainage density is the average length of stream or channel per unit area. It is measured to learn about the structured lithologic relief and the climate of the area. Resistance rocks and area show erosion and have low density, erodable character will develop many stream and have a higher density. Horton in 1932 made a quantitative is calculated by expressing in the following manner—

$$D = \frac{\sum L}{A}$$

$\sum L$ = Total Channel length of the basin.

A = Total Area of the basin.

D = Drainage Density

‘D’ is the drainage density in per square km area is calculated by the total length of channel within the area and divided by the total area of the basin. The total length of the stream of different orders in the catchment area is to the calculated and divided by total catchment area, where the catchment area is small. In a large catchment area with higher order the area is divided into grid of unit area, the length of stream and measurement and plotted at the centre. Lines of equal density are drawn at the selected values and that given the donation of density pattern.

IDENTIFIED DRAINAGE PATTERNS

Map No: 73^A/₁



WATER BODIES

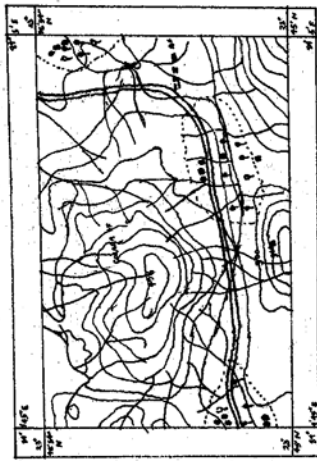

RADIAL DRAINAGE



DENDRITIC DRAINAGE



PARALLEL DRAINAGE

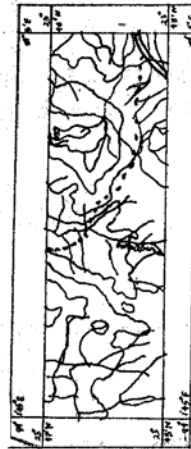

R.F. 1:50,000

The sheet number of the given topographical sheet map is 73^A/₁. It represents part of Palamu district of the Bihar. The scale of the map is 1:50,000 that is 2 cm on the map represent 1 km on the ground. Here the contour interval is 20 metre. The region extends from 23°45'N and 84°E to 84°15'E.

The regions is a fluvialy dissected plateau area by North Koel river and its tributaries with isolated ridges and conical hill. The underlying geological structure, surface morphometry and stages of evolution have given rise to a variety of physical features which are shown here are:

- V shaped river valley
- Flattened valley
- Gully erosion and badland topography
- Sand bank
- Point bar.

CALCULATION FOR DRAINAGE DENSITY, MAP NO 73^A/₁

Sl. No.	Grid Number	Length of Drainage in cm	Length of Drainage in km	Drainage Density (in km/km ²)
1.	A ₁	5	2.5	2.5
2.	A ₂	5	2.5	2.5
3.	A ₃	6	3	3
4.	A ₄	6	3	3
5.	A ₅	8	4	4
6.	A ₆	6	3	3
7.	B ₁	6	3	3
8.	B ₂	6	3	3
9.	B ₃	6	3	3
10.	B ₄	7	3.5	3.5
11.	B ₅	6.3	3.25	3.25
12.	B ₆	6.5	3.25	3.25
13.	C ₁	5	2.5	2.5
14.	C ₂	7	3.5	3.5
15.	C ₃	8	4.5	4
16.	C ₄	9	4.5	4.5
17.	C ₅	10	6	5
18.	C ₆	7	3.5	3.5

19.	D ₁	4	2	2
20.	D ₂	7	3.5	3.5
21.	D ₃	8	4.5	4.5
22.	D ₄	10	5	5
23.	D ₅	8	4	4
24.	D ₆	9	4.5	4.5
25.	E ₁	6	3	3
26.	E ₂	8	4	4
27.	E ₃	8	4	4
28.	E ₄	9	4.5	4.5
29.	E ₅	6	3	3
30.	E ₆	4	2	2

DRAINAGE DENSITY MAP

PALAMU DISTRICT, BIHAR

MAP NO: 73⁴/₁

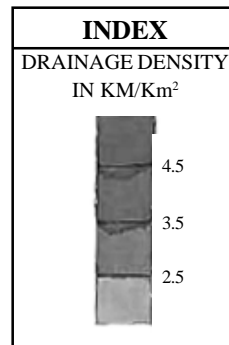
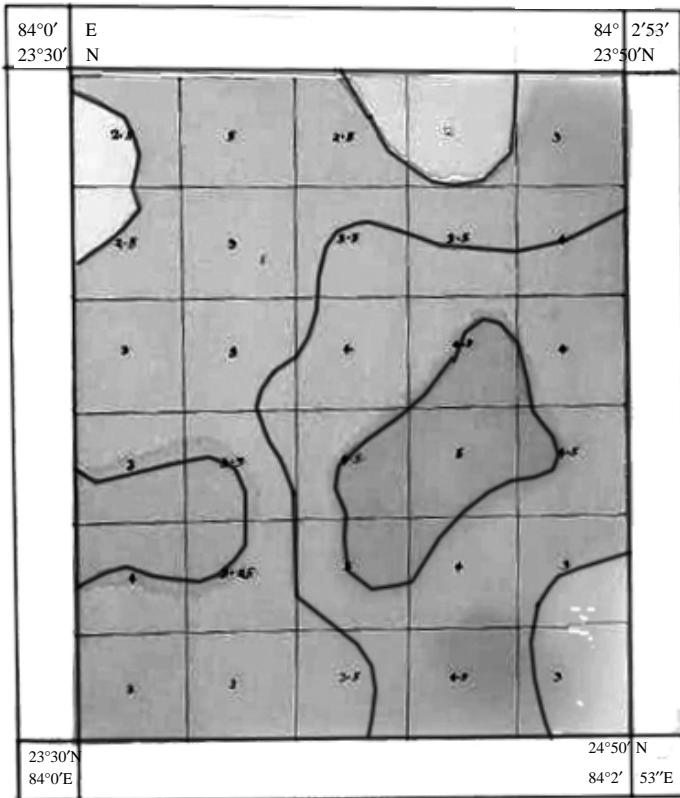

R.F. 1:50,000

INTERPRETATION OF DRAINAGE DENSITY (MAP NO. 73^A/1)

Drainage density is the average length of stream or channel per unit area. It is measured to learn about the structured lithologic relief and the climate of the area. Resistance rocks and area show erosion and have low density, erodable character will develop many stream and have a higher density. Horton in 1932 made a quantitative is calculated by expressing in the following manner—

$$D = \frac{\Sigma L}{A}$$

ΣL = Channel length of the basin.

A = Total Area of the basin.

D = Drainage density

The topographical sheet bearing the no 73^A/1 covers part of Palamu district of Bihar state. The area chosen to show drainage density of particular portion of 73^A/1, represents both perennial and non-perennial river. Latitudinally the selected area extends from 23°50'N to 23°53'16"N, longitudinally extends from 84°E to 86°2'53"E. The selected area covers about 30 sq. km of area.

The highest drainage density 5 km/km² and lowest drainage density is about 2 km/km². In the drainage density map three isolines have been drawn at 1 km/km² interval. The values of the isolines are 2.5 km/km², 3.5 km/km², 4.5 km/km². As a whole the central and south-eastern part have higher drainage density. The medium drainage density areas are in eastern, partly central, southern part. The lower density areas are north and northwest part. The degree of drainage density depends on the rock structure, nature of precipitation, degree of vegetal cover and sunlight.

3.4 Relative Relief, Stream Frequency and Drainage Density of a common area

The Relative Relief, Stream Frequency and Drainage Density of a common area are calculated from the topo Map No. 72^K/₈ to represents the corelations of them—

Calculation table for relative relief, stream frequency and drainage density

Grid No.	Highest Altitude(m)	Lowest Altitude(m)	Relative Relief(m)	No. of Streams	Length of Drainage (cm)	Length of Drainage (km)
1.	360	200	160	9	9.5	4.75
2.	460	200	260	8	6.0	3.00
3.	440	200	240	8	5.0	2.50
4.	220	100	120	5	6.0	3.00
5.	140	100	40	5	5.5	2.75
6.	400	160	240	5	4.5	2.25
7.	480	220	260	7	4.5	2.25
8.	480	120	360	8	8.5	4.25
9.	180	100	80	5	5.0	2.50
10.	99	61	38	2	1.5	0.75
11.	440	180	260	7	4.5	2.25
12.	489	200	289	10	5.0	2.50
13.	380	100	280	6	6.5	3.25
14.	119	81	38	5	6.5	3.25
15.	100	80	20	2	5.0	2.50
16.	400	160	240	8	5.0	2.50
17.	420	140	280	8	5.5	2.75
18.	240	100	140	7	6.5	3.25
19.	NA	NA	120	3	7.0	3.50
20.	99	61	38	2	2.0	1.00
21.	300	120	180	4	4.0	2.00
22.	340	100	240	6	7.0	3.50
23.	240	100	140	4	2.5	1.25
24.	119	81	38	4	4.5	2.25
25.	119	81	38	2	3.5	1.75

RELATIVE RELIEF MAP

Munger District, Bihar

Toposheet No. 72K/8

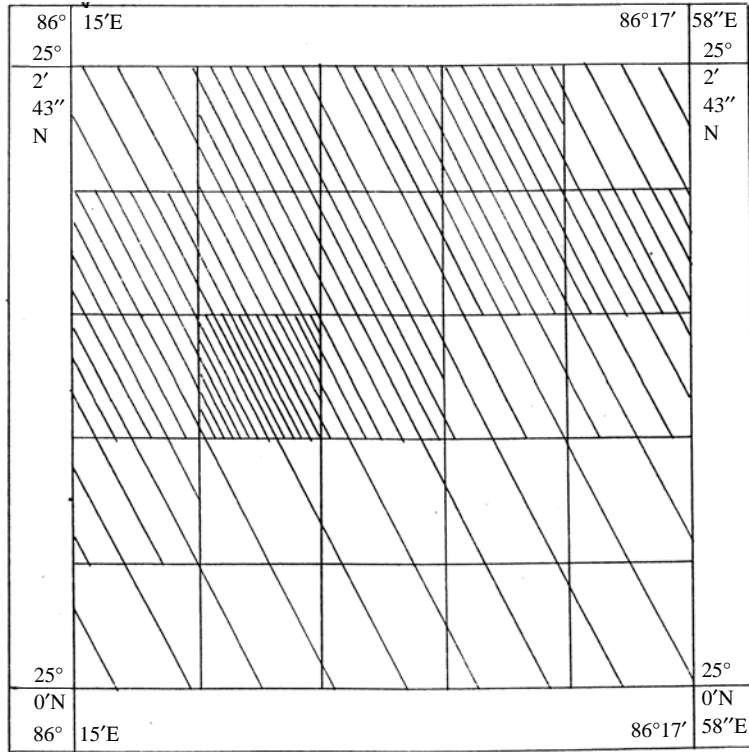

R.F.—1:50,000

Relative Relief table			
Relative Relief Range	Grid No.	Shading	Remarks
0 – 100	5, 9, 10, 14, 15, 19, 20, 24, 25		Very Low
100 – 200	1, 4, 18, 21 23		Moderately Low
200 – 300	2, 3, 6, 7 11, 12, 13 17, 16, 22		Moderately High
300 – 400	8		Very High

INTERPRETATION OF RELATIVE RELIEF MAP

A relative relief map has been drawn for the extension $86^{\circ}15'E$ and $86^{\circ}17'58''E$ and $25^{\circ}0'N$ and $25^{\circ}2'43''N$ in the survey of India topographical map no. 72^K/₈. The area has been divided into 25 square grid with 1 km/1km dimension. For each grid highest altitude and lowest altitude have been recorded or estimated. The difference between this gives the value of relative relief. The smaller the relative relief, the flatter the terrain and the higher the relative relief the more rugged the terrain is. The map shows that North-Eastern grid, the southern grid and extreme North-Western grid are comparatively more flat. The landscape presents an undulating topography. In the west central grid the topography is the most rugged one, with a value more than 300 metres. In the remaining grids the topography is moderately rough with moderate relative relief. Relative relief will increase if the land is rugged. The degree of ruggedness depends on the dissection of the land which depends on stream frequency. There is a chain reaction or consequences of some morphometric techniques. Like : Stream Frequency → Drainage Density → Dissection Index → Ruggedness Index → Relative Relief → Average Slope.

STREAM FREQUENCY MAP



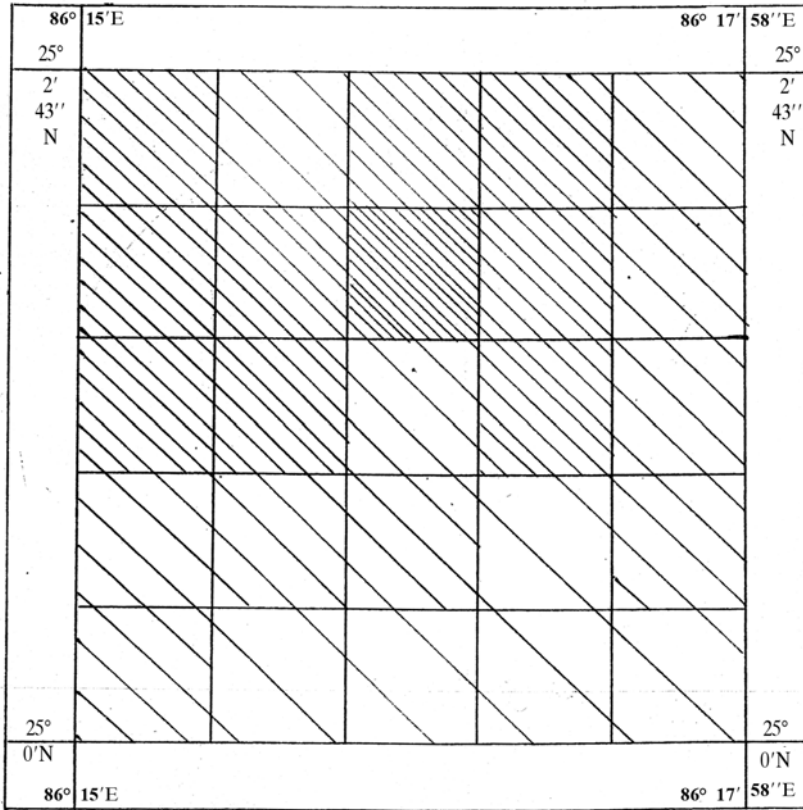

Munger District, Bihar

Toposheet No. 72K/8



Stream Frequency table

R.F.—1:50,000

Stream Frequency Range	Grid No.	Shading	Remarks
1 – 3	10,15,19 20, 25		Very Low
4 – 6	4,5,6,9,13,14 21,23,24		Moderately Low
7 – 9	1,2,3,7,8,11, 16,17,18		Moderately High
10 – 12	12		Very High

INTERPRETATION OF STREAM FREQUENCY MAP

Stream frequency is the number of streams per sq. km area. It leads to drainage density. For the given grids, stream frequency map has been prepared to show the nature of drainage. The map has been divided into 25 sq. grids of equal dimension. In each grid, no. of channel have been counted and stream frequency has been calculated by dividing the no. of channel with the area. Stream frequency is very high in the central part of the northern half. It is very low in the southern part. In the remaining part stream frequency is found in the plateau region with more rainfall and high degree of slope. Lower frequency means relative plain land with lower slope.

DRAINAGE DENSITY MAP

Munger District, Bihar

Toposheet No. 72K/8

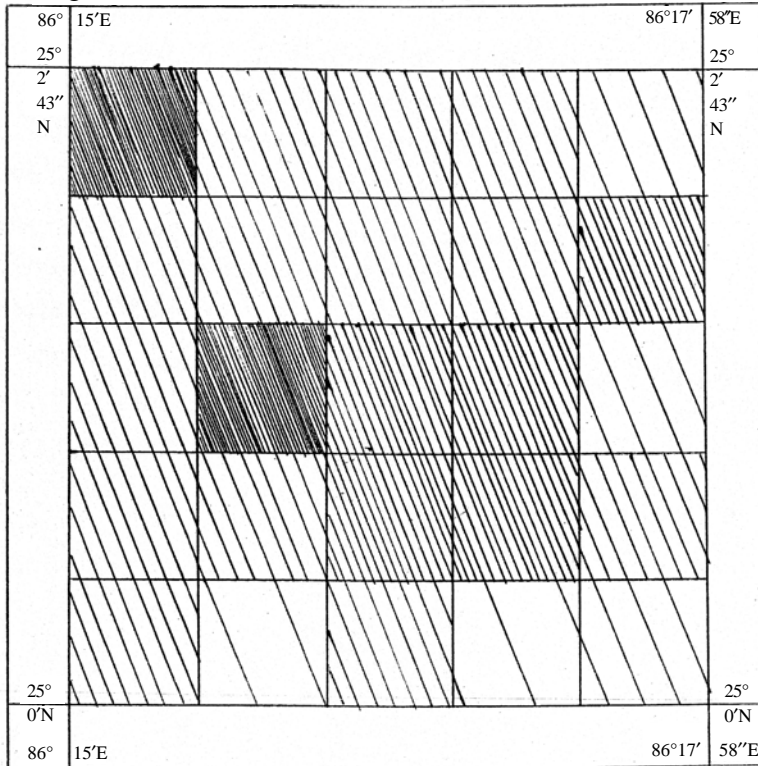

R.F.—1:50,000

Drainage Density table			
Drainage Density Range	Grid No.	Shading	Remarks
0 – 1	10, 20		Very Low
1 – 2	21,23,25		Low
2 – 3	2,3,4,5,6,7 9,11,12,15, 16,17,24		Moderately
3 – 4	13,14,18,19,22		High
4 – 5	1,8		Very High

INTERPRETATION OF DRAINAGE DENSITY MAP

A drainage density map has been drawn to show the distribution of length of drainage per sq. km. The map has been prepared by choropleth method. It shows that drainage density is very high in the north-western part and very low in the southern part. In the south eastern part drainage density is moderately high. In the remaining area, it is moderately low. More the length of drainage signifies, the more stream frequency and more the relief signifies, the more the precipitation, and more the slope.

3.5 Vegetation Map

The sheet no. of the given topographical map is 73A/1. It represents part of Palamu district of Bihar. The scale of the map is 1:50,000 that is 2 cm on map represents 1 km on the ground. The region extends from 23°45'N to 24°0'N and from 84°0'E to 84°15'E.

There are a number of reserved and protected forest in the region. The reserved forests of the region are Hutar Reserved Forest, Harilong Reserved Forest, Putuagarh RF, Betla Reserved Forest, Saidup Reserved Forest etc, and the Karma PF, Datam Protected Forest, Palpol Protected Forest, Barichatan PF etc. The main rivers are North Koel River and Auranga River.

The area which is covered by forest is about 60% of the total map. Most of the forest area is covered by dense sal jungle. In the left bank of the North Koel River there are so many reserved and Protected forest like Harma PF, Musurmju PF, Huban RF, Hura PF, Chunga PF, Adan PF etc. Which are mostly dense mixed sal jungle. In the right bank of the North Koel River, there is Kewatirar Protected Forest. North part of the Auranga river is Palpal PF, which is mainly mixed jungle of eucaliputus. In the south part of Auranga river is Belta Reserved Forest which is mainly mixed jungle of bamboo. And the other forest are Mourwai PF, Dohara RF etc. which are in the south part of the map. It can be seen from the region that most of the highly dissected plateau surface, with elevation above 300m is covered by sal forest. Most of the area below 250m is mostly covered by different kinds of plantation and dense scrub.

VEGETATION MAP

PALAMU DISTRICT, BIHAR

MAP NO : 73^A/₁

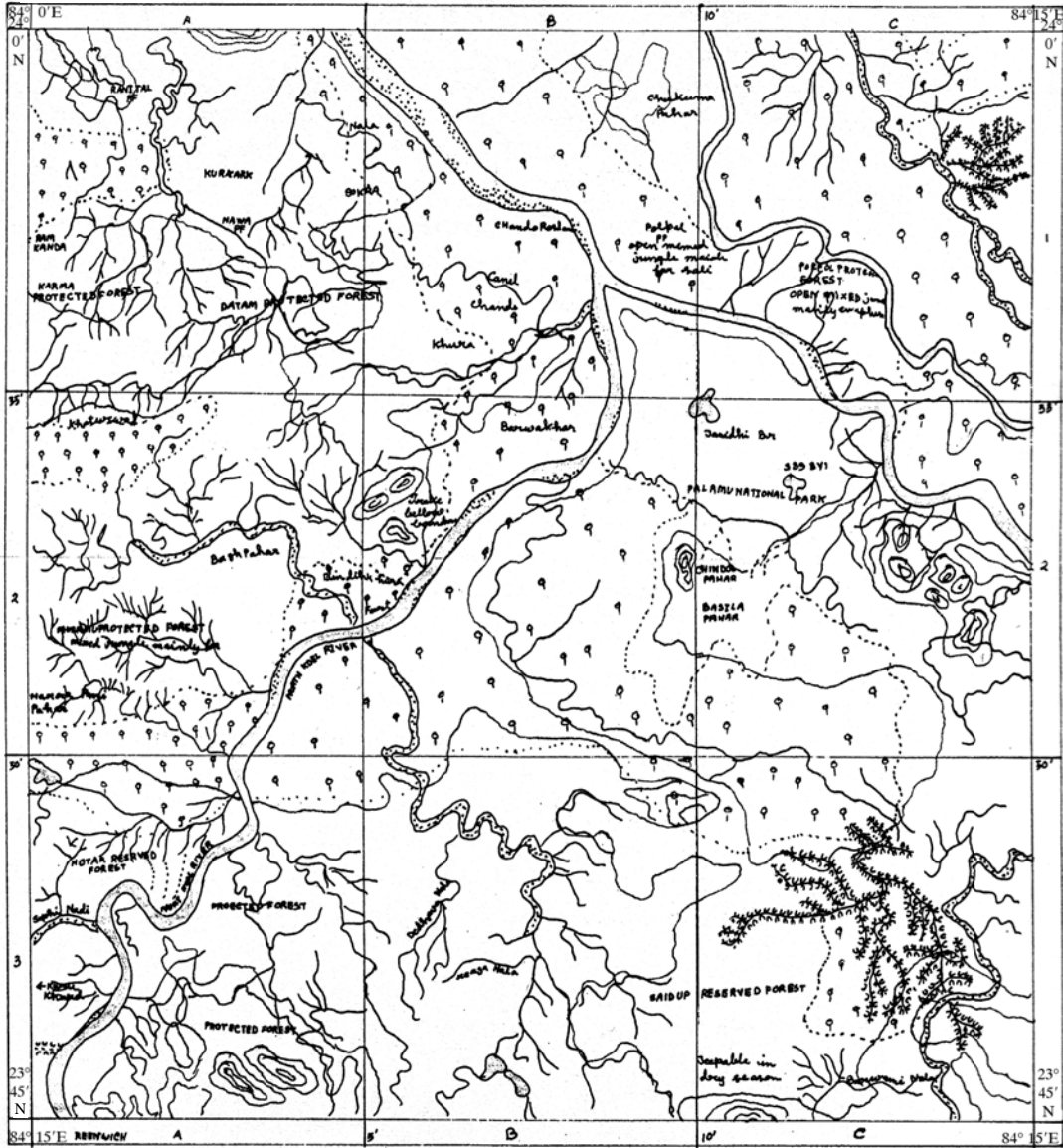

(Rough Sketch)

3.6 Settlement and Communication Map

The whole area is covered by mostly rural settlement with only one site showing development of when settlement at Rainalokal. The settlement pattern is clearly associated with topography and drainage of the region. The nature of settlement may be a rural due to rugged terrain and dissected topography. In area of high relief and dense forest, small clusters have developed at the forest clearing. These clusters are developed either by the side of unmetalled road or by side of small tributary streams. But mostly these are found on the plateau fringe area with relatively less slope. Few example can be given from the north-western part, like Bali, Haria, Bantalai, Sahaybahah, Khalo etc.

Isolated settlement are notice in the south-eastern sector on the slopes of dissected plateau surface which is connected with other settlement clusters by footpath and cart track. Some nucleated settlement have development on the right bank of Champal Nadi. This area is relatively flat with elevation, not exceeding 250m. Only few conical hill with elevation above 300m can be noticed along the NH₄ metalled road, connecting Rairakhal with Deogarh. This area also has a few water tanks mostly man made and settlement have demarcated around this water and pond at Dioneha, Tandabria, Kathuria, Paikmat etc. Some other examples are of such water point Nuliation is found, in the south-western part of the region between the Kutunia Nala and NH₄. Some examples are Kuli, Parabalanda, Helai etc. Such small clusters are seen to developed at the junction of small foot paths that diverge in all directions like the scapes of a wheel and the settlement occurrence of the hub of the wheel.

Linear settlement have developed mostly along the NH₁₂ and some other metalled roads which are off shoots from the NH. Such settlement are prominent near Bamur in the extreme south-east corner of the region. It can be noticed that those settlement are relatively larger. With few urban facilities like Post Office, market place and transport facility. Rainakhal the only large urban clustered is developed on both banks of Drineha Nala. However, its locational development can be mainly a tributary to the presence of the a number of metalled roads tributing NH. Though the settlement has developd on the side of river but the river being non-perennial and highly silled is not expected to play an important role in the development of Rainakhal at the junction of roads. It has hospital, post office, markets, revenue office, a few temples, P.W.D banglow, and even a vetenary hospital. The area is served by power line.

SETTLEMENT AND COMMUNICATION MAP

Map No: 73^A/₁

PALAMU DISTRICT, BIHAR

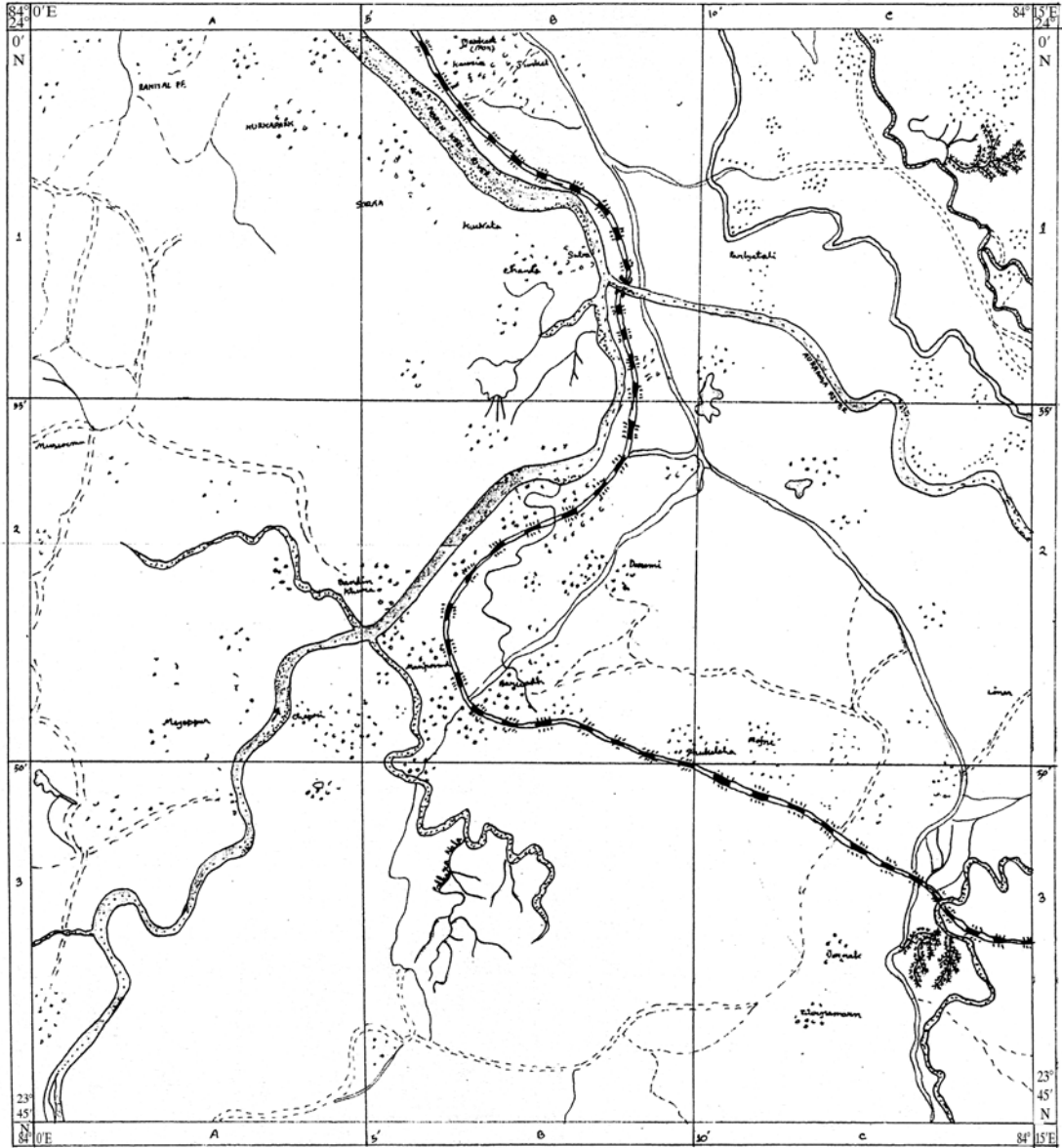

ROUGH SKETCH

3.7 Transect Chart: Correlation between physical and cultural features

The transect chart provides a useful and graphic means of sampling and summarising the various distribution of structural surface and human activities and of revealing their similarities and construts. It was developed for use in presenting the result of intensive local survey which among other things, rainfall, vegetation and agriculture can be fully studies because in it relief, drainage, vegetation, transport and communication and settlements are represented.

The transect chart is located in the B₂ grid. The transect chart is drawn on AB line. The location of A point to 84°5'27"E and 23°54'30"N and the location of point B is 84°7'41"E and 23°50'30"N. Through the transect chart, the interrelation among the physical and cultural features are shown. It has been seen that the height of the profile has been decreased from A to B i.e., from North-West part to South-East part where the altitude is higher number of streams are higher and most of them are non-perennial. On the other hand, the number of streams have decreased where altitude has decreased. Hence perennial river have taken the place of non-perennial river. In this profile we have seen that on the dissected plain, the perennial river North Koel is flown. More over, since it is flowing on the plain area, sand banks is developed due to despositional work of the river.

In the case of vegetation cover, we can also establish to its relation with physiography and others. In this profile vegetation cover is seen at the both ends of the profile where the altitude is higher and ruggedness, exist, agriculture and settlement cannot be development easily. Communication system has also a deep relationship with the topography. In the areas near point A has more heights, more ruggedness, dense forest cover as a result communication system as well as settlement has not been developed.

TRANSECT CHART

Showing

The relationship between physical and cultural elements

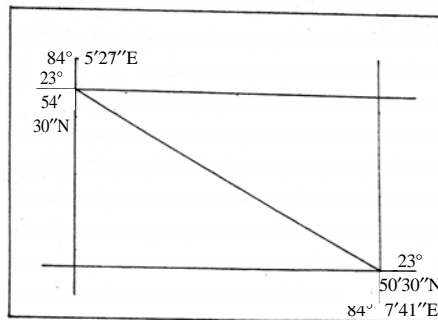
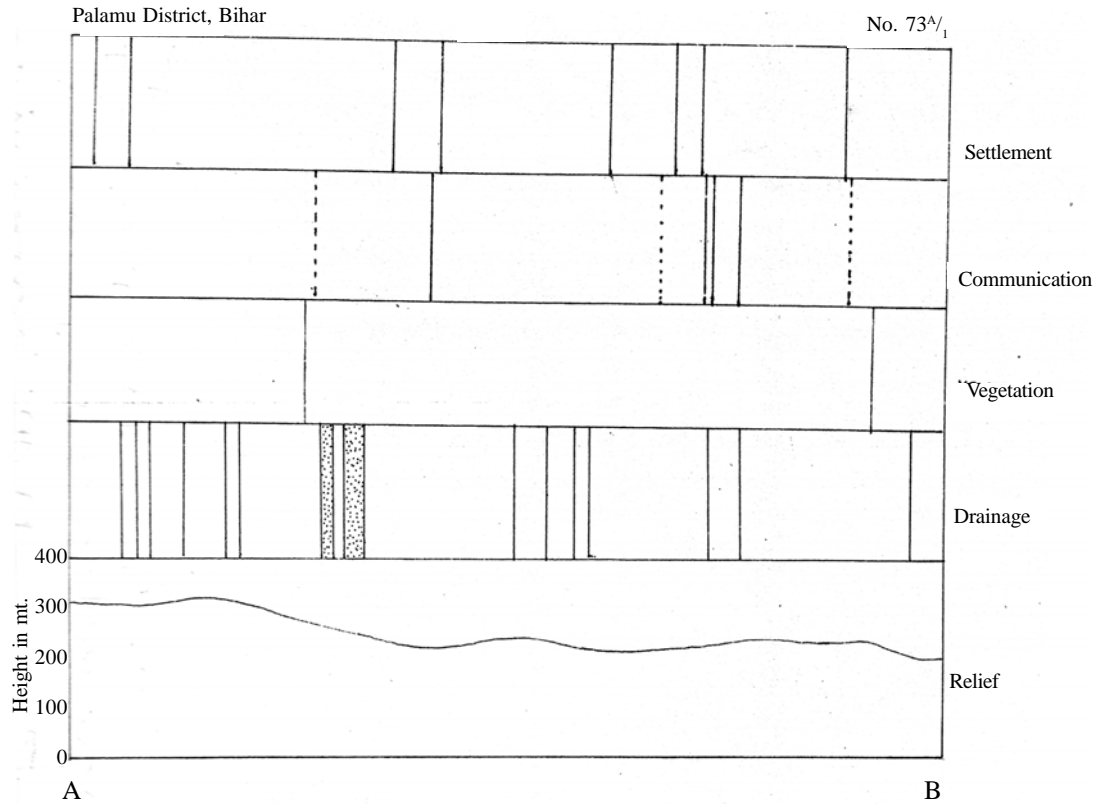

SCALE

VERTICAL SCALE : 1 cm \cong 100 metre

HORIZONTAL SCALE : 1 cm \cong 500 metre

3.8 Interpretation of Topographical map according to questions

3.8.1 Example 1

[Question: Interpret the topographical map in the following heads—

1. Describe the physiography of the area.
2. Prepare a Average Slope map (10 cm × 12 cm grids).
3. Describe the vegetation cover of the area and establish the relationship between slope and vegetation cover.
4. Relate the slope with the settlement of the map.
5. Prepare a transect chart and interpret it.

Answer

Introduction:

- Map No. 73^C/₈
- Geographical location:
Latitude: 21°00'N to 22°15'N
Longitude: 84°15'E to 84°30'E
- State: Orissa
- District: Dhenkanal and Sambalpur
- Map Scale: 2 cm to 1 km
- RF: 1:50,000
- Survey: 1979-80
- Published: 1980
- Surveyer: Major General Keshari Lal Khosla, Serveyer General of India

REPRESENTATIVE PROFILE

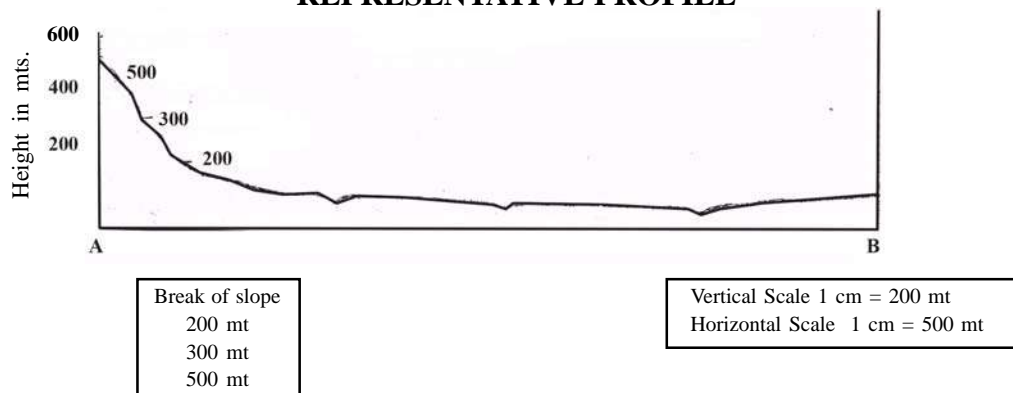

Interpretation:

The board physiographic division showing the referred region into few division—

- 1. Hilly region:** This region elevated from 400 - 600 mt where the natural vegetation is highly concentrated. There several reserved forest, protected forest, dense forest have been observed.
- 2. Plateau region:** This region elevated from 200 - 400 mt. Some protected forests have been covered in this plateau region.
- 3. Erosional plain:** Erosion plain ranged from 100 - 200mt. The main river flow from north-western part to south-western part of the map. Therefore, the plantation dissected by river and the area is mostly covered by vegetation.

Table: Showing the gridwise Average slope in degree/km²

Grid No.	No. of contour crossing per grid	Average Slope in degree/Km ²
A ₁	10	4°29'27"
A ₂	11	4°56'16"
A ₃	11	4°56'16"
A ₄	5	2°14'56"
A ₅	4	1°47'58"
A ₆	2	0°53'59"
B ₁	8	3°35'43"
B ₂	14	6°16'29"
B ₃	8	3°35'43"
B ₄	6	2°41'53"
B ₅	6	2°41'53"
B ₆	0	0°0'0"
C ₁	16	7°9'45"
C ₂	22	9°48'12"
C ₃	23	10°14'23"

Grid No.	No. of contour crossing per grid	Average Slope in degree/Km ²
C ₄	16	7°9'45"
C ₅	6	2°41'53"
C ₆	8	3°35'43"
D ₁	25	11°6'32"
D ₂	30	13°15'30"
D ₃	19	8°29'15"
D ₄	20	8°55'38"
D ₅	6	2°41'53"
D ₆	4	1°47'58"
E ₁	22	9°48'12"
E ₂	23	10°14'23"
E ₃	19	8°29'15"
E ₄	32	14°6'29"
E ₅	31	13°41'3"
E ₆	2	0°53'59"

Interpretation: The average slope map is drawn through the Wentworth's method.

$$\text{Formula: Average Slope } (\theta) = \tan^{-1} \frac{\text{Average no. of contour crossing per grid} \times \text{contour interval.}}{636.6}$$

It has extend to the latitude 21°0'N to 21°2'N and longitude 84°27'E to 84°30'E. The slope of the region is south-western to north-eastern direction. The steep slope is concentrated at the north-western portion which is indicated by dark colour and the gentle or low slope is observed at the western part of the region.

AVERAGE SLOPE MAP

(Wentworth's Method)

Map No: 73 $\frac{C}{8}$

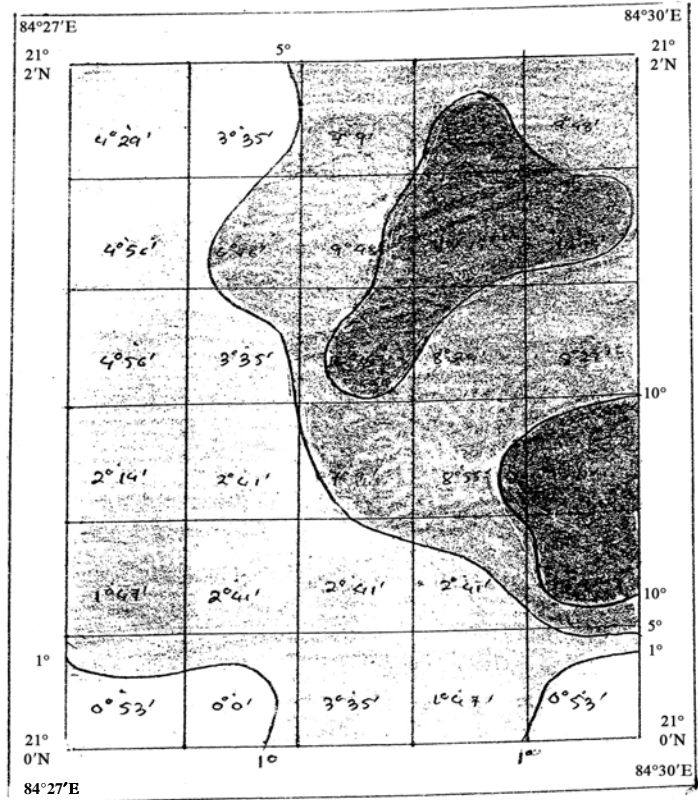

R.F. → 1:50,000

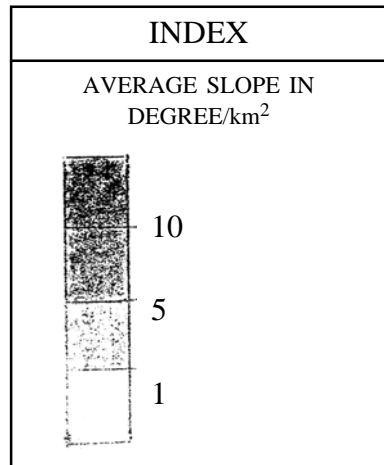

AVERAGE SLOPE MAP

(Wentworth's method)

with

VEGETATION COVER

Map No: 73^C/₈

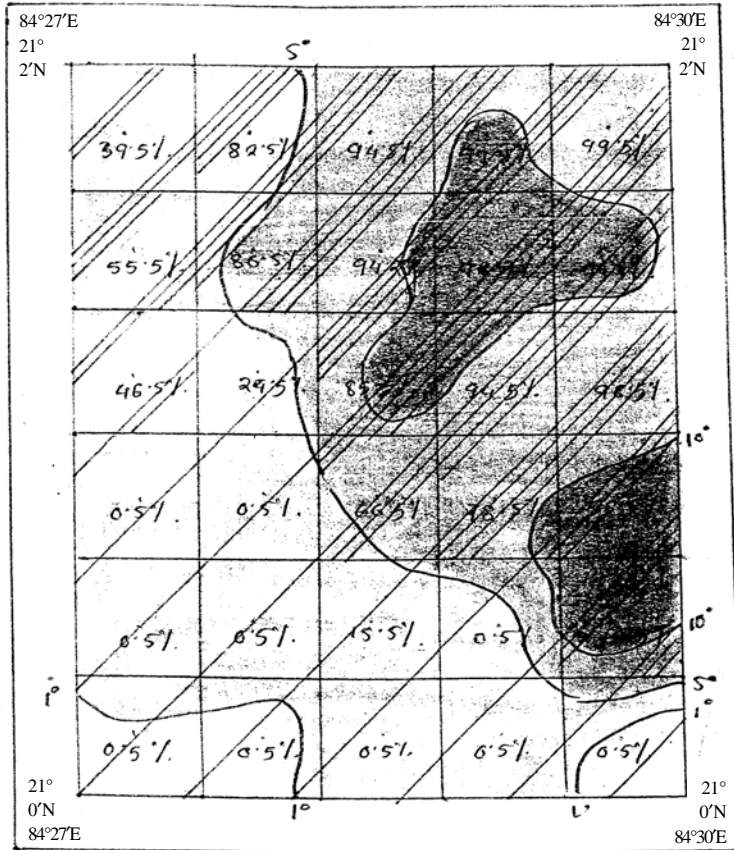

RF → 1:50,000

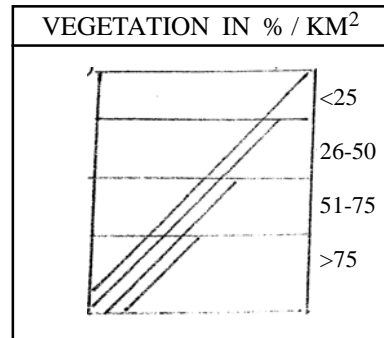
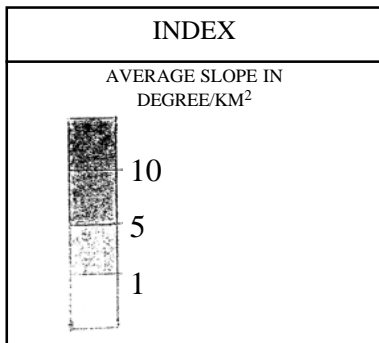

Interpretation: The vegetation cover is more in highly elevated as well as steep slope area. The slope of the region is south towards north-east direction. The steep slope is concentrated in the north-eastern portion where the dense forest is also found. The gentle slope area is cover with less vegetation than the high angle of slope. Therefore the density of vegetation is proportional to the amount of average slope. The density of vegetation increasing with the slope and vice versa.

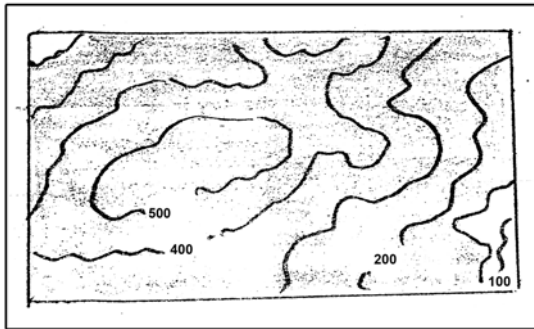

Dense forest

Dense forest: Dense forest is located where the elevation of relief is high and characterised by closely placed contour. The high elevated region is covered by natural dense forest. In reffered topomap several dense forest have been seen at the northernwestern and easter part of the region.

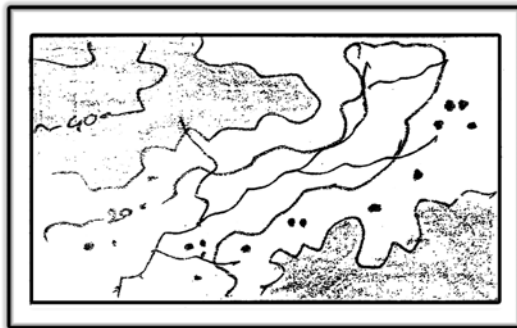

Moderate Dense forest

Moderate dense forest: It had been found on the plateau region with the range of 200 - 400mt height.

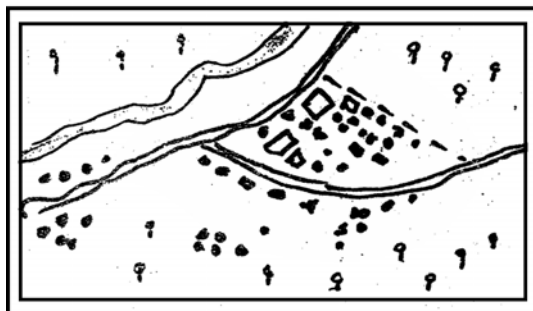

Deforestation or scarce vegetation: In the river vally or lowland area is characterise by scarce vegetation due to settlement density which is more in this area.

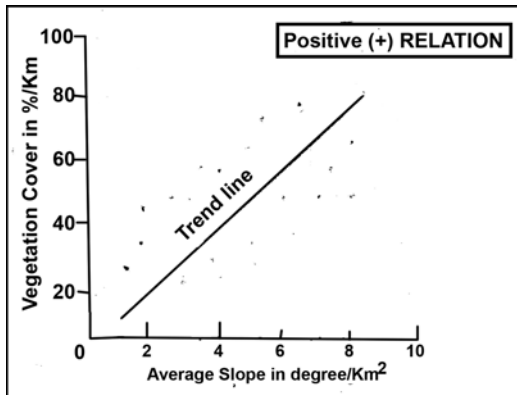

Scatter Diagram

Scattered Diagram: By the scatter diagram the relation of relief and vegetation is represented the vegetation density is showing on the vertical axis ranges from 0 - 100% and the average slope is showing on the horizontal axis range from steep to gentle (0 to 10 Degree). The example is showing the density of vegetation is increasing with the slope and vice versa. The relation is positive in north-east to south-west direction.

AVERAGE SLOPE MAP
(Wentworth's method)
with
SETTLEMENT DENSITY

Map No: 73 $\frac{C}{8}$

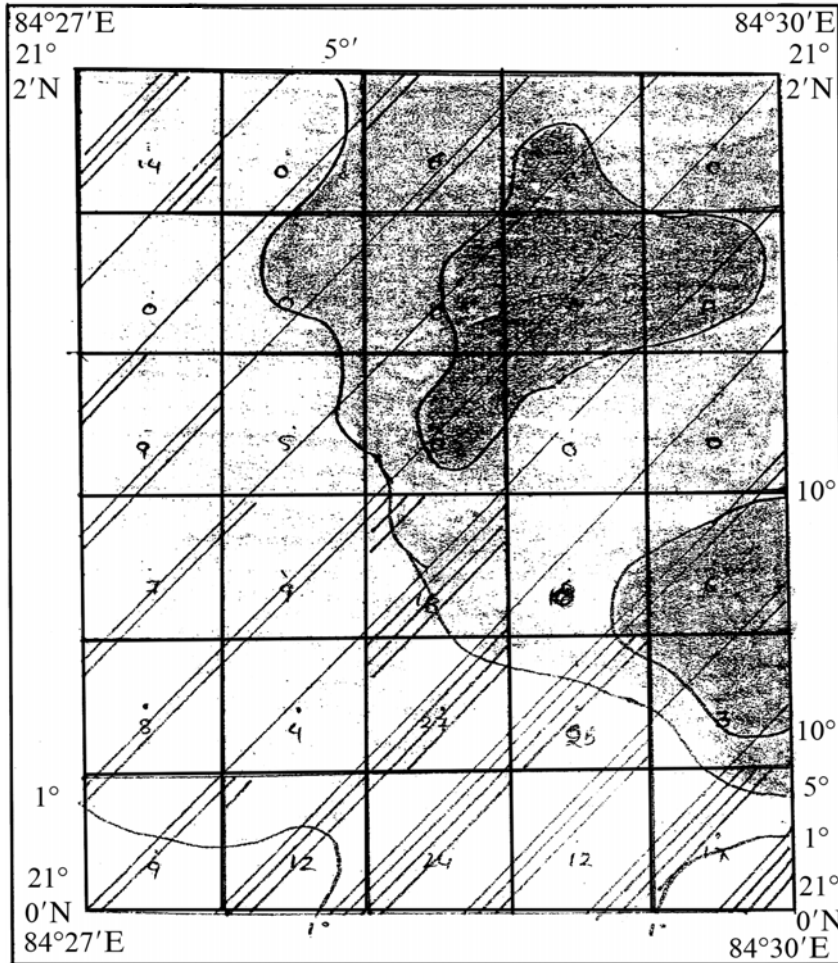

RF→1:50,000

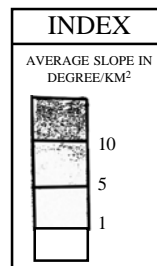
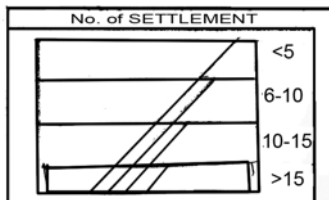

Interpretation: The well developed settlement is developed over the gentle slope of the region. Due to gentle slope, the natural vegetation, the rugged topography, the settlement cannot developed properly in steep slope area. The slope of this region is south-west toward north-eastern direction. Therefore, the concentration of settlement is decrease towards the high slope area.

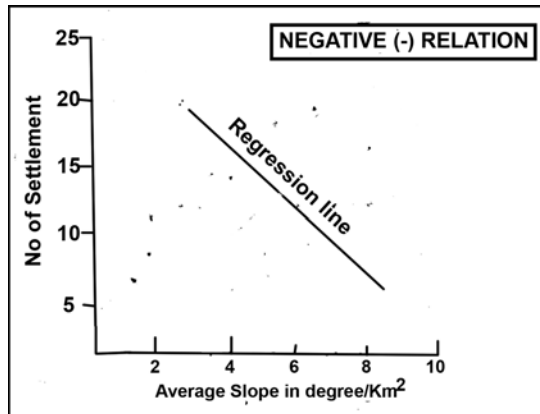

Scatter Diagram

The scatter diagram showing the relationship between the slope and settlement. The average slope is represent at the horizontal axis range from 0 - 10° and the settlement density is shown at the vertical axis ranges from 0 - 25. The example showing the density of settlement is decreasing with the slope and vice versa. Therefore, the relation of them is negative.

TRANSECT CHART

Showing

The relationship between physical and cultural elements

Map No. 73^C/₈

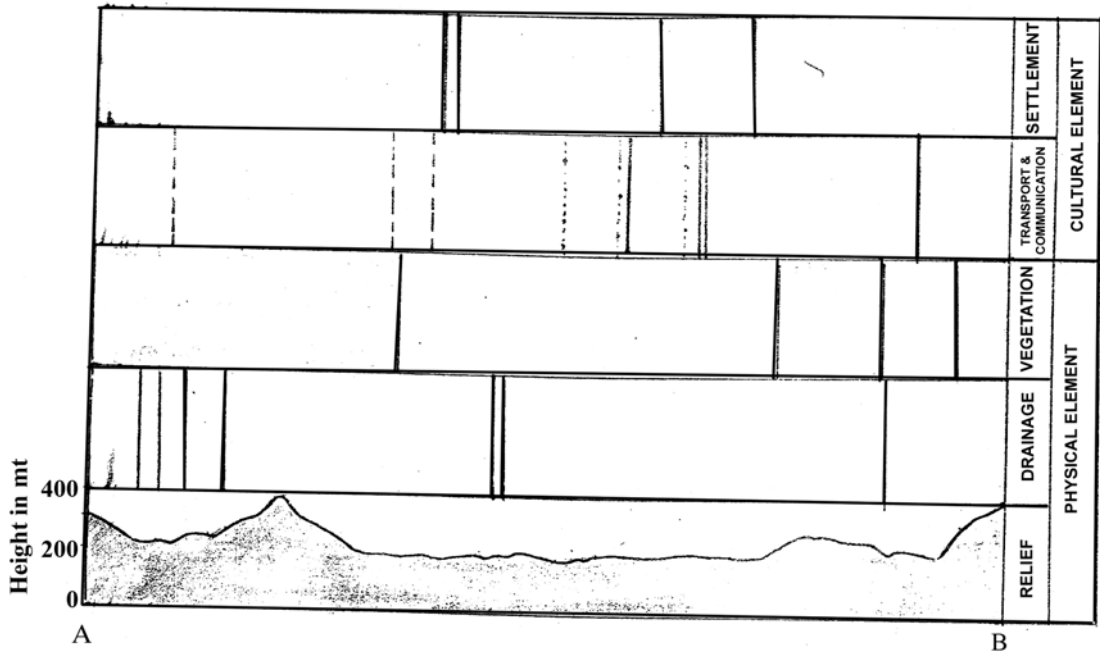

ROUGH SKETCH OF TOPOMAP

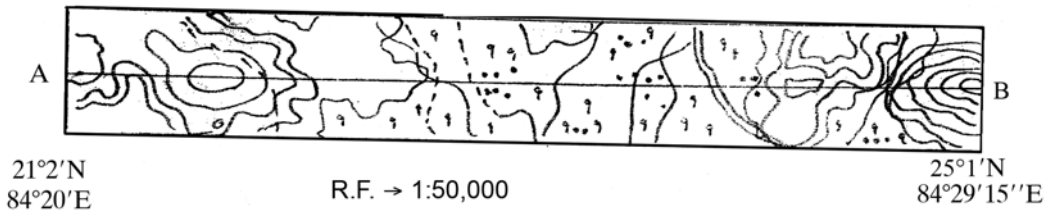

Interpretation: The broad and unique way to represent the physical and cultural elements is transect chart. The transect chart has the latitude 21°2'N to 22°2'N and longitude 84°27'E to 84°29'E.

(1) **Relief:** The relief of this region is elevated from 180 to 400m. The region is highly plateau region characterized by some conical hill.

(2) **Drainage:** The rivers are flowing north-easter to southern part following the slope.

(3) **Vegetation:** The high elevated area is covered by natural and dense forest. The river valley is less covered by vegetation due to well density of settlement and transport.

(4) **Transport and Communication:** The lower plateau is well developed of transport and communication. Due to rugged topography and natural vegetation the high land is less developed in communication.

(5) **Settlement:** The plane or lowland area is characterised by compact or linear settlement.

3.8.2 Example 2:

Question

1. Describe the physiography and vegetation cover of the given map.
2. Describe the geomorphic features and drainage pattern of the given map.
3. Establish the relationship of slope and drainage of the area using morphometric techniques (10 cm × 12 cm area). Use transect chart and scatter diagram to illustrate your answer.
4. Prepare a Average Slope map (10cm × 12cm area) from the given topo map.
5. Draw a transect chart and interpret it.

Introduction:

- **Map No.** 73C/8
- **Geographical location:**
 - Δ **latitude:** 21°0'N to 21°15'N
 - Δ **longitude:** 84°15'E to 84°30'E
 - Δ **State:** Orissa
 - Δ **District:** Dhenkanal and Sambalpur
- **Map Scale:** 2cm = 1km
- **R.F:** 1:50,000
- **Surveyed:** 1979-80
- **Surveyer:** Major General Kishari Lal Khosla,
Surveyer General of India
- **Published:** 1980

BROAD PHYSIOGRAPHIC DIVISION MAP WITH VEGETATION COVER

Map No: 73^C/₈

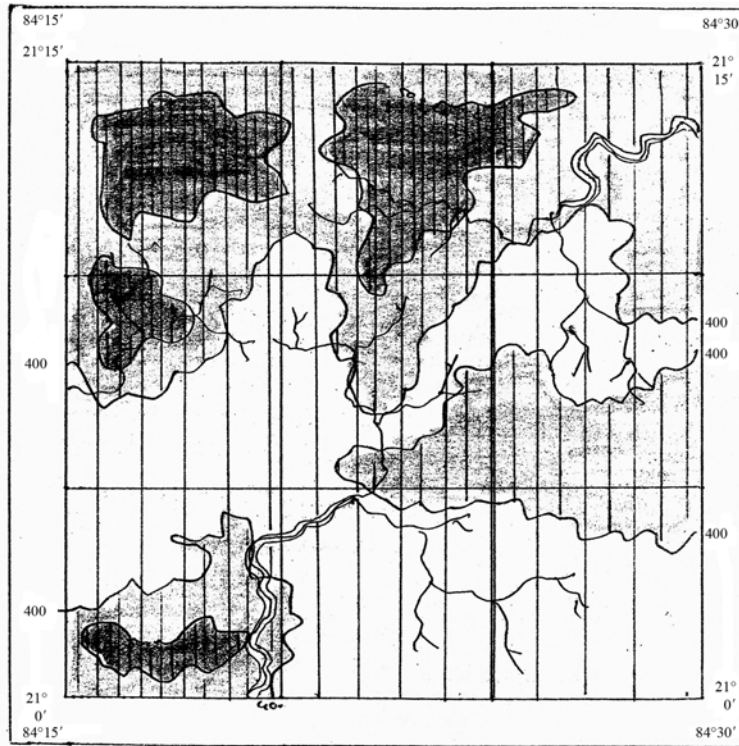

NOT TO SCALE

REPRESENTATIVE PROFILE

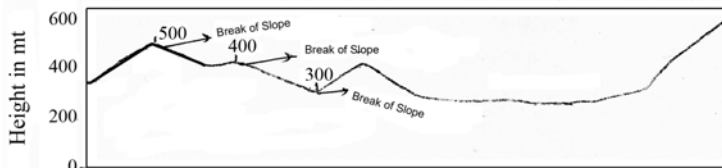

BREAK OF SLOPE
300 m
400 m
500 m

HORIZONTAL SCALE : 1 cm ≅ 500 m
VERTICLE SCALE : 1 cm ≅ 200 m

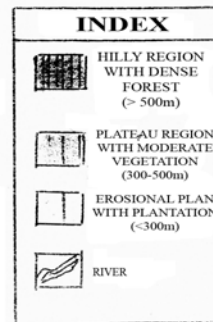

Interpretation: The broad physiography division map with vegetation cover is drawn with the latitude of 21°0'N to 21°15'N and longitude of 84°15'E to 84°30'E in 12cm × 12cm grid. There are three division of this region—

- 1) Hilly region (>500m)
- 2) Plateau region (300–500m)
- 3) Erosional plain (<300m)

Divisions	Altitude ranges in metre	Geographical location	Landuse and Landcover
Hilly region/ plateau proper	>500m	At the north, north-western, and south-western portion of Sambalpur.	Due to rugged topography this area is less active for agriculture. This area is covered by natural dense forest due to high elevation. Due to rugged topography, unavailable groundwater, under developed transport system, settlements scatterly developed
Plataeu/region lower plateau	300 – 500m	At the central and northern portion of Sambalpur district	This area is partly practice of aggric-ulture and the region is covered with moderate vegetation settlements are develop dispersly.
Erosional plan	< 300	At the southern, north-eastern portion of Sambalpur and Dhenkanal district	Due to fertile land, the area is use agricultural practise. The area is covered only with plantation due to urbanisation. The settlements are found more in the plain due to well developed transport and communication.

PHYSICAL FEATURES (Geomorphic)

Conical hill :

The conical hill have been seen in the C₃ grid. The higher elevation is 591m and the lower elevation is 180m.

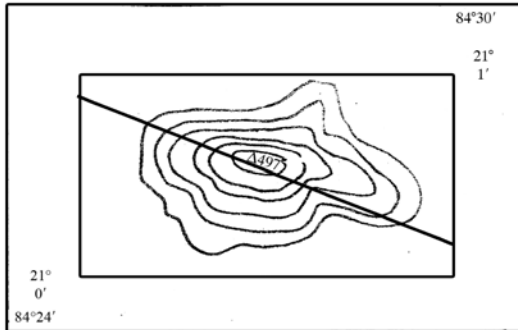

Conical Hill

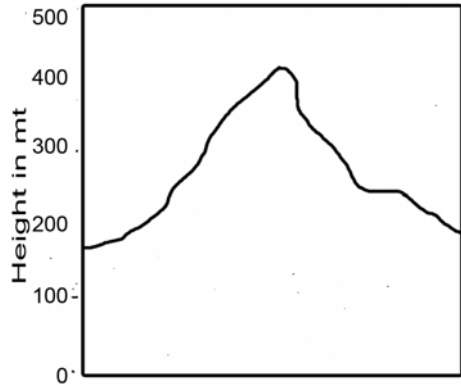

Flat-topped hill:

The surface of the peak is flat. The elevation of flat topped hill ranges from 150m to 320m. It has been found in B₃ grid.

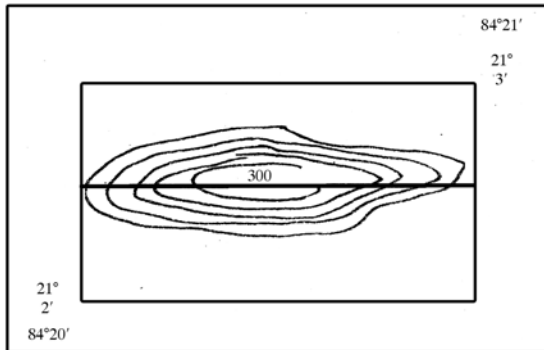

Flat-Toped Hill

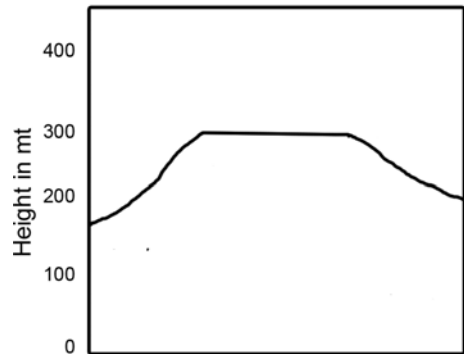

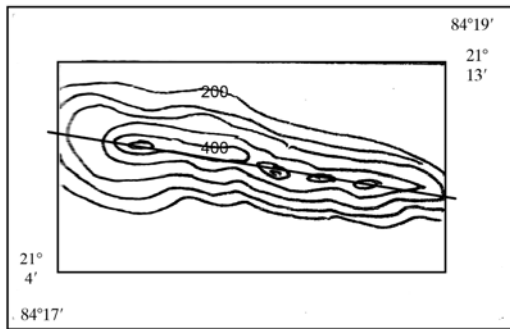

Ridge

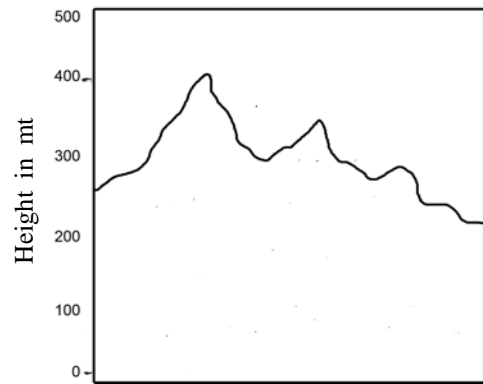

Ridge:

There are four peak is found in this ridge. The higher elevent is 480m and the lower elevation is 230m. It is found in the A₂ grid.

DRAINAGE PATTERN:

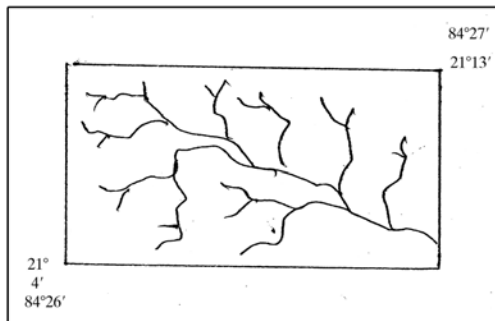

Dendritic Drainage Pattern

Dendritic Drainage Pattern:

There are several drainage networks adjacent to the main stream in all direction and in all magnitude. They resemble it with root, banches of tree. It is developed where the rocks have resistance to erosion.

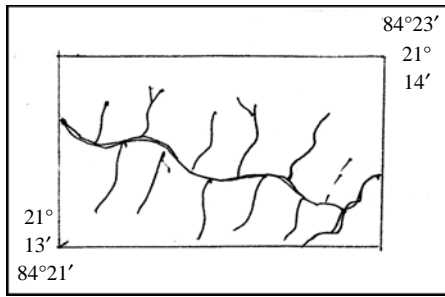

Parallel Drainage Pattern

Parallel Drainage Pattern:

Parallel drainage pattern network which are all parallel to each other. It is form where there is alternate hard and soft rock on the surface.

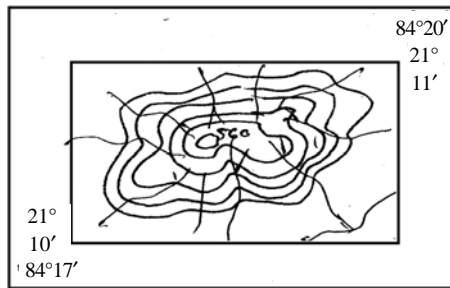

Radial Drainage Pattern

Radial Drainage Pattern:

Radial drainage pattern is an important drainage pattern. The drainage network diverted or radiate out from control higher point.

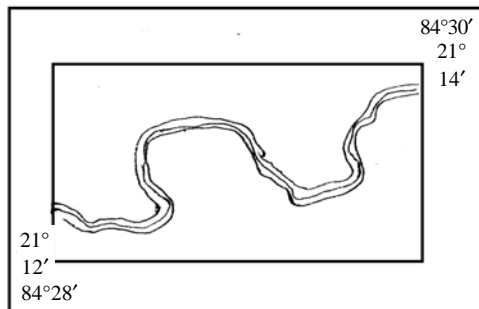

Meandering Drainage Channel

Meandering Channel:

Meandering Channel is controlled by structural rock. The flow is bend when the stream is facing hard rock on their path and there are heterogenic rock surface.

AVERAGE SLOPE MAP

(Wentworth's method)

with

DRAINAGE NETWORK

Map No: 73 $\frac{C}{8}$

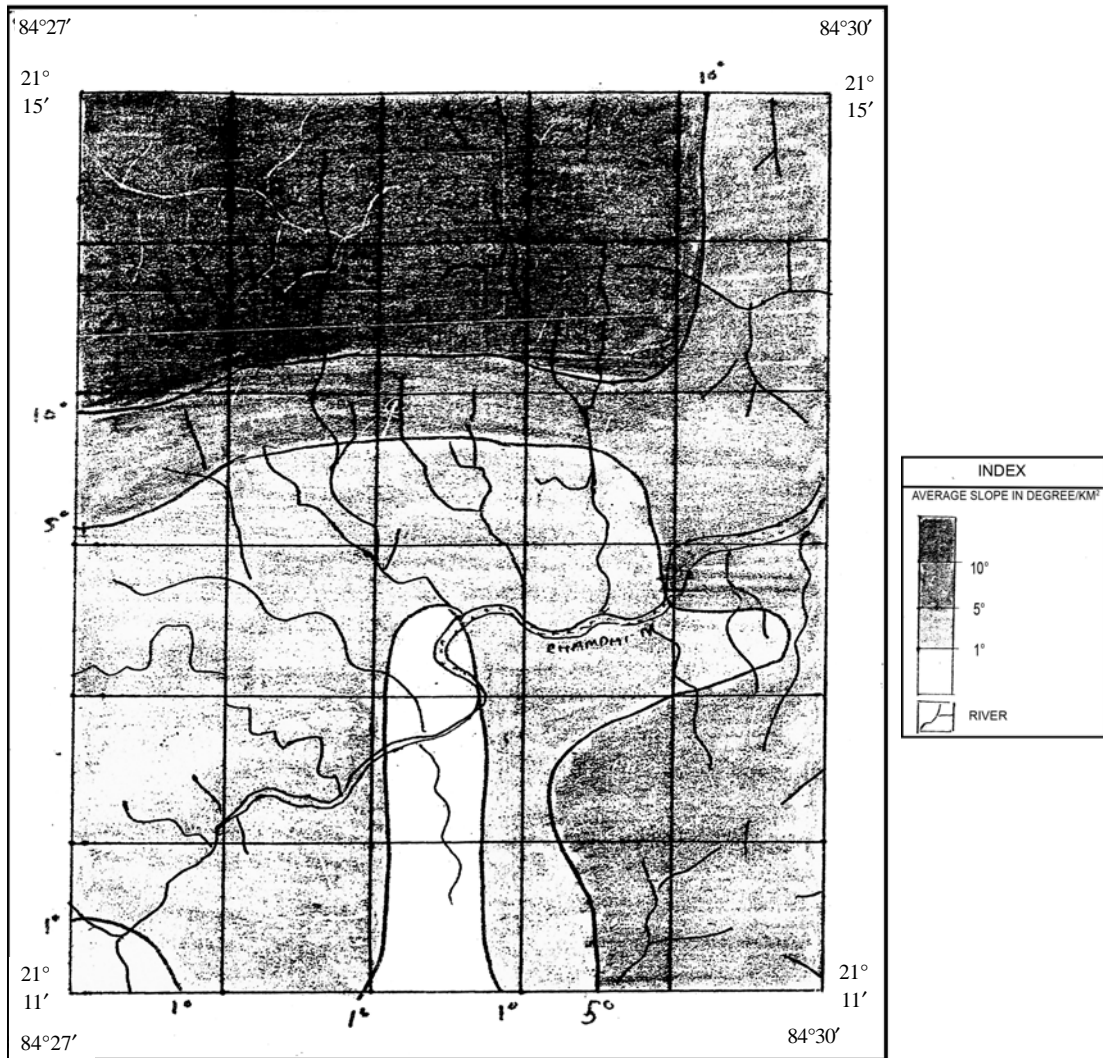

RF → 1:50,000

Interpretation:

The average slope map with superimposed by the drainage network is drawn with the latitude 21°11'N to 21°15'N and the longitude of 84°27'E to 84°30'E to represent relief and drainage. The steep slope is found at northern portion which is determined by first part ordering stream. The gentle slope of the relief is concentrated at the southern portion of this region where the no. of stream ordering is increasing. The river is flow from northern to southern part following the regional slope.

TRANSECT CHART

Showing

The relationship between Relief and Drainage (MAP No. 73^C/8)

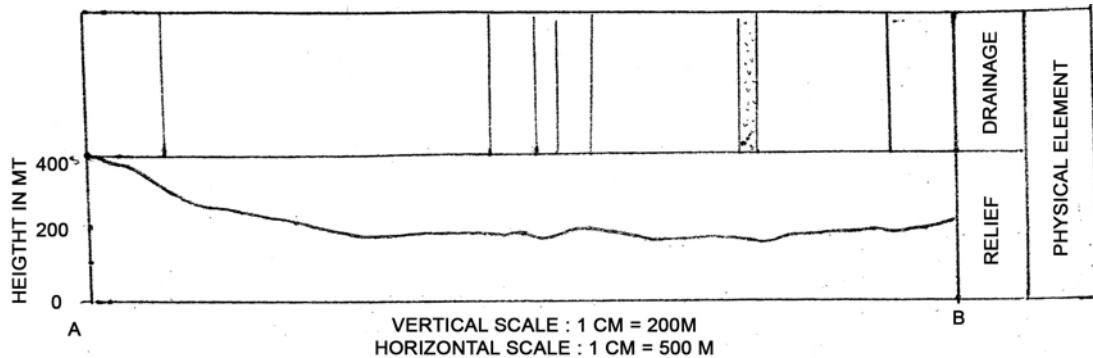

Rough Sketch of Topo Map

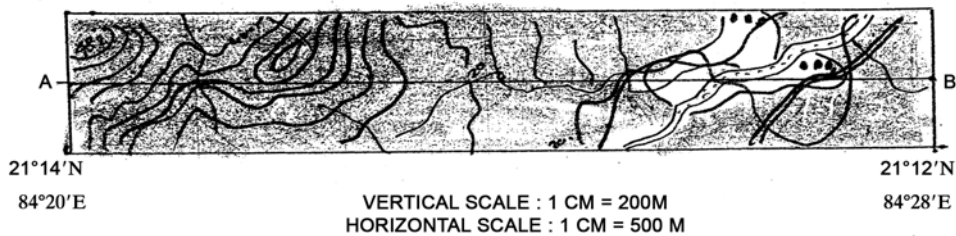

Interpretation:

The transect chart is the very unique way to represent the relationship between physical and cultural element on a single frame. The transect chart is drawn along the section line AB with the latitude 21°19'N to 21°14'N and the longitude of 84°20'E to 84°28'E.

(1) **Relief:** The relief ranges from 200 – 400m. The relief is dissected by river. The higher elevation is seen at the northern part.

(2) **Drainage:** The river is flowing from northern to southern direction following the slope.

SCATTER DIAGRAM

Showing

The relationship between Relief and Drainage

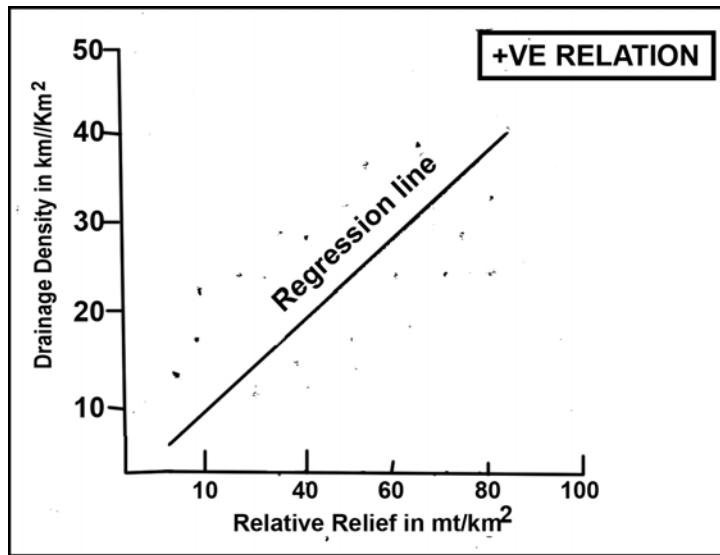

The scatter diagram represents the relationship between relative relief and drainage. The horizontal axis is determined by the relative relief range from 0 – 100m and the vertical axis is determined by the drainage density ranges from 0 – 50 km. km². By the example, it is noted that with the increasing of the relief, the density of drainage is increase and vice versa. Therefore the relation of them is positive.

Table: Showing the guidwise Average slope in degree/km²

Grid No.	No. of contour crossing per grid	Average Slope in degree/km ²
A ₁	41	17°50'59"
A ₂	34	14°57'5"
A ₃	14	6°16'29"

Grid No.	No. of contour crossing per grid	Average Slope in degree/km ²
A ₄	8	3°35'43"
A ₅	4	1°47'58"
A ₆	2	0°53'49"
B ₁	48	20°39'23"
B ₂	36	15°47'18"
B ₃	9	6°2'36"
B ₄	5	2°14'56"
B ₅	5	2°14'56"
B ₆	8	3°35'43"
C ₁	39	17°1'50"
C ₂	31	13°41'3"
C ₃	4	1°47'58"
C ₄	2	0°53'49"
C ₅	2	0°53'49"
C ₆	2	0°53'49"
D ₁	38	16°37'5"
D ₂	30	13°15'30"
D ₃	11	4°56'16"
D ₄	7	3°8'48"
D ₅	14	6°16'29"
D ₆	11	4°56'16"
E ₁	20	8°55'38"
E ₂	19	8°29'15"
E ₃	16	7°9'45"
E ₄	10	4°29'27"
E ₅	20	8°55'38"
E ₆	17	7°36'18"

$$\text{Average Slope } (\theta) = \tan^{-1} \frac{\text{Average no. of contour crossing per grid} \times \text{contour interval}}{636.6}$$

TRANSECT CHART

Showing

The relationship between physical and cultural elements.

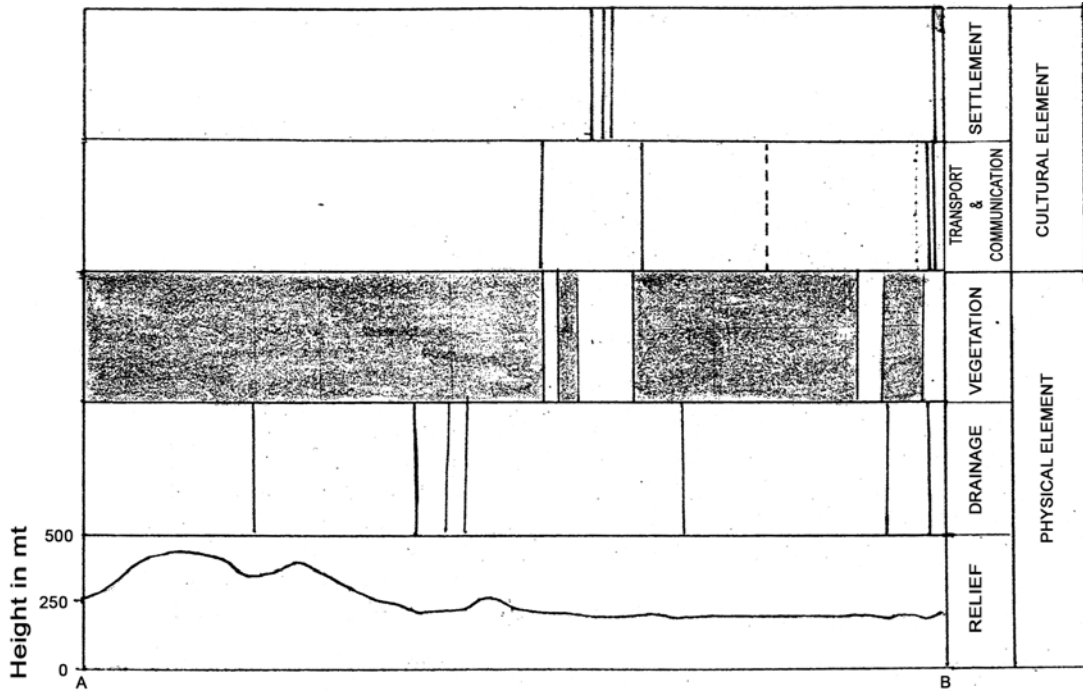

ROUGH SKETCH OF TOPO MAP

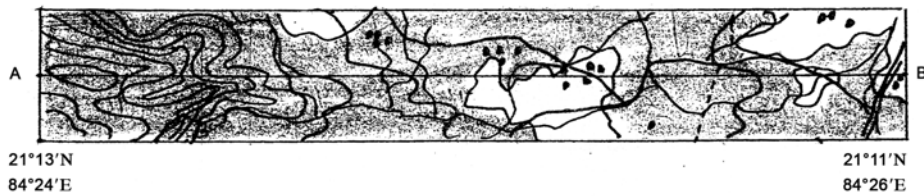

HORIZONTAL SCALE : 1 CM \cong 500M
 VERTICAL SCALE : 1 CM \cong 250M

Interpretation :

The transect chart is a very unique and broadway to represent the relationship between physical and cultural elements. The transect chart is drawn along the section line AB with latitude of 21°11'N to 21°13'N and the longitude of 84°24'E to 84°26'E.

(1) **Relief:** The highest elevation of the relief is 460m and the lowest elevation of the relief is 200m. The relief is a plateau region dissected by river.

(2) **Drainage:** The higher elevated area is determined by first ordering stream and the no. of stream ordering an increasing near the low land area.

(3) **Vegetation:** The hilly region is occupied by dense vegetation whereas the floodplain is characterised by plantation only.

(4) **Transport and Communication:** The floodplain is well developed in transport and communication where due to natural vegetation cover and ruggedness, the transport network is not developed in upper plateau.

(5) **Settlement:** In the upper plateau the settlement developed dispersely or isolated whereas the floodplain is characterised by well developed settlement.

Unit 4 □ Delineation of Drainage Basin and Construction of Hypsometric curve

Structure

4.1 Delineation of Drainage Basin

4.1.1 Introduction

4.1.2 Other Terms

4.1.3 Importance

4.1.4 Delineation/measures of Drainage Basin

4.1.5 Properties of Drainage Basin

4.1.6 Base map of Drainage Basin

4.1.7 Distribution of Drainage Density

4.1.8 Distribution of Stream Density

4.2 Hypsometric Curve

4.2.1 Introduction

4.2.2 Significance

4.2.3 Types

4.2.4 Drawing of the Hypsometric Curve

4.2.5 Advantage

4.2.6 Drainage Basin for calculation and drawing of hypsometric curve

4.2.7 Hypsometric Curve [Drawing]

4.1 Delineation of Drainage Basin

4.1.1 Introduction: A drainage basin is an area where precipitation collects and drains off into a river, bay or other body of water. It includes all the surface run off water and ground water underneath the earth's surface.

4.1.2 Other Terms:

- (i) Catchment area, (ii) Catchment basin, (iii) Drainage area, (iv) River basin, (v) Water basin.

4.1.3 Importance:

Drainage basin has tremendous importance due to its—

- (i) Geospatial or geopolitical Boundaries
- (ii) Hydrological Character
- (iii) Geomorphological Unit
- (iv) Ecological Character
- (v) Resource Management

4.1.4 Delineation / Measures of Drainage Basin:

The significant landmark of the quantitative measure of drainage basin analysis, is the introduction of the R.E. Horton's (1934) empirical relationship of the linear, areal and relief properties of the drainage basin, further modified by A.N. Strahler (1952). This is followed in quick occassion by a other techniques by A.E. Scheidegger (1965), R.I. Shreve (1967), Woldenberg and many others.

The drainage basin is supposed to be composed of both qualitative and quantitative variables which can be evaluated either in terms of the attributes and variates respectively.

Qualitative Altributes

1. Geology
2. Structure
3. Soil types
4. Vegetation
5. Landforms types
6. Drainage types

Quantitative Variables

- A. Size and Shape
 - a. Areal change
 - b. Shape Indices
- B. Relief
 - a. Elevation
 - b. Ruggedness
 - c. Dissection
 - d. Slope
 - e. Distribution

- C. Linear Network
 - a. Texture
 - b. Density
 - c. Frequency and Pattern
- D. Hydrology
 - a. Climatic variables
 - b. Relief
 - c. Discharge
 - d. Velocity

4.1.5 Properties of Drainage Basin:

The drainage basins are composed basically of four different properties—

- (1) Areal (2) Relief (3) Linear (4) Hydrological properties.

As the drainage basin is the area drained collectively by the network of a river along with its tributaries and subtributaries, it is demarcated by drawing a line along the network boundary or watershed. Its shape reflects the nature of the basin hydrology and can be measured by using the formula:

(1) Form factor (index of form) = A/L^2

(2) Elongation Ratio = $P/\pi L$

(3) Circularity Ratio = $4\pi A/P^2$

(4) Lemniscate Ratio = $\pi L^2/4A$

(5) Index of shape = L/B

(where, A = Basin Area, L = Maximum basin length, P = Basin Parameter, B = Basin width)

The different drainage basin shapes are—

- (a) Narrow elongated
- (b) Bi-directional
- (c) Multi directional
- (d) Oval shaped
- (e) Circular form
- (f) Irregular shaped

In most commonly applied indices measuring the fluviometric properties of drainage basin or any grid area from topo map are:

(1) Drainage Frequency (Df) = $\frac{\text{Number of channels}}{\text{Area}}$

(2) Drainage Density (Dd) = $\frac{\text{Length of channels}}{\text{Area}}$

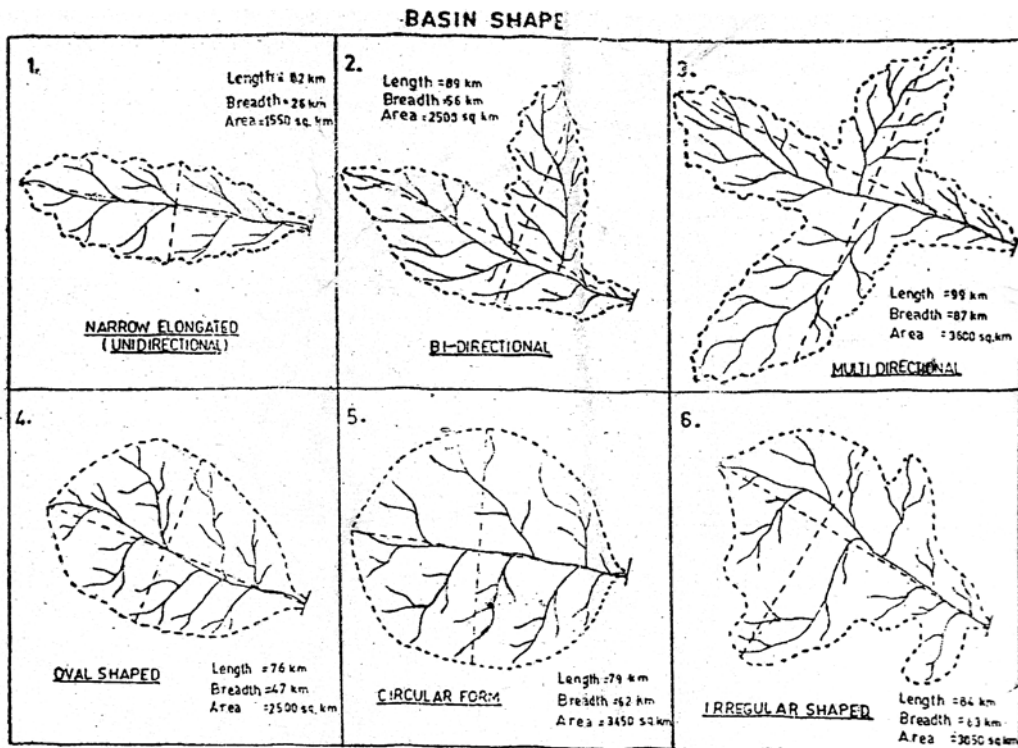

INDEX OF SHAPE

	BASIN NO.					
	1	2	3	4	5	6
1. Index of Form = $\frac{A}{L^2}$	0.2395	0.3156	0.3673	0.4328	0.5528	0.4321
2. Index of Shape = $\frac{L^2}{A}$ (Corps of Eng)	4.3380	3.1664	2.7275	2.3104	1.8090	2.3134
3. Do (After Horton) = $\frac{L}{B}$	3.1538	1.5892	1.1379	1.6170	1.2741	1.3353
4. Circularity Ratio = $\frac{P_c}{C}$	0.5395	0.4309	0.2827	0.7854	0.8958	0.4669
5. Elongation Ratio = R_E	0.5418	0.6339	0.6838	0.7423	0.8388	0.7419

THE MEASURES OF MAGNITUDE—AREA AND SHAPE

4.1.6 Base Map of Drainage Basin

Map No: 73^F/₈

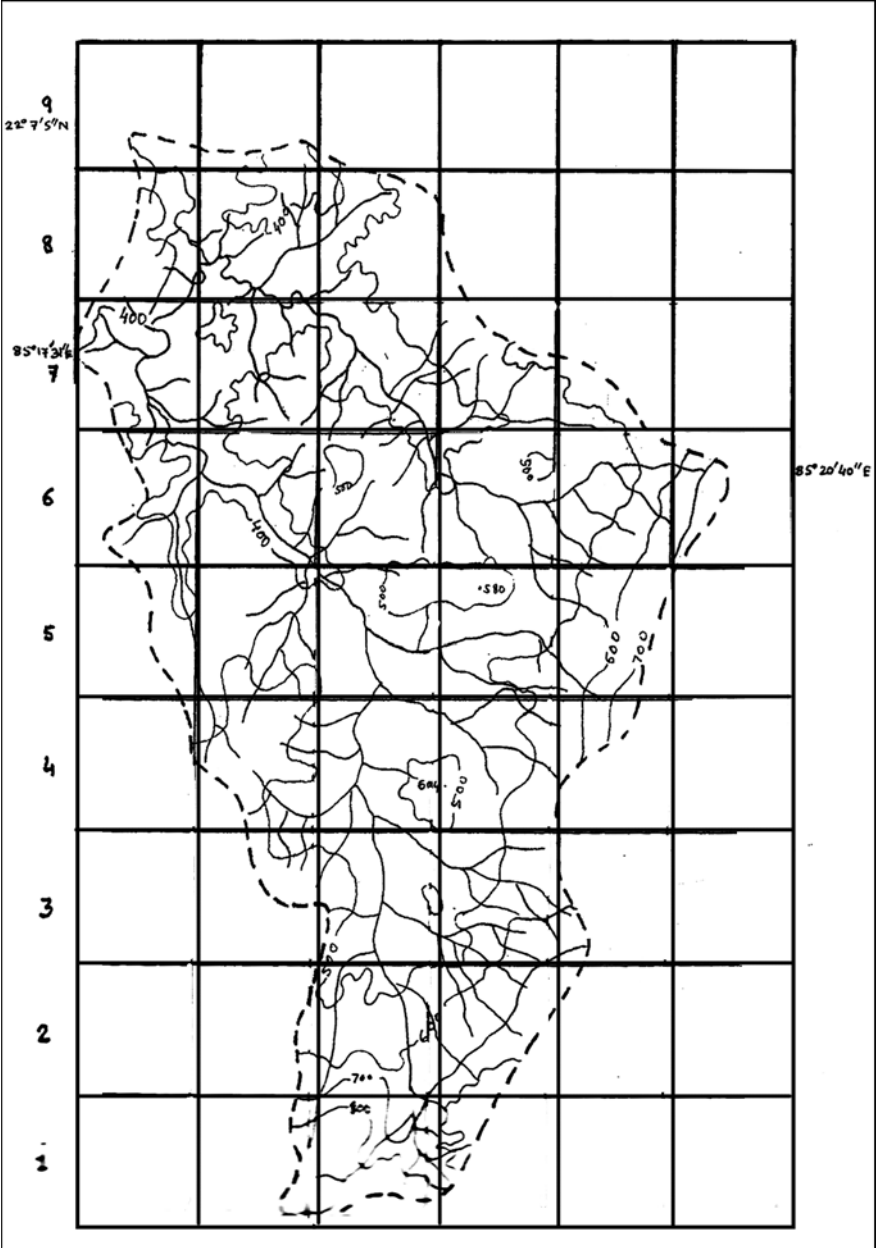

4.1.7 Distribution of Drainage Density

DISTRIBUTION OF DRAINAGE DENSITY BY CHOROPLETH METHOD BAHADA DRAINAGE BASIN

Map No: 73 $\frac{E}{8}$

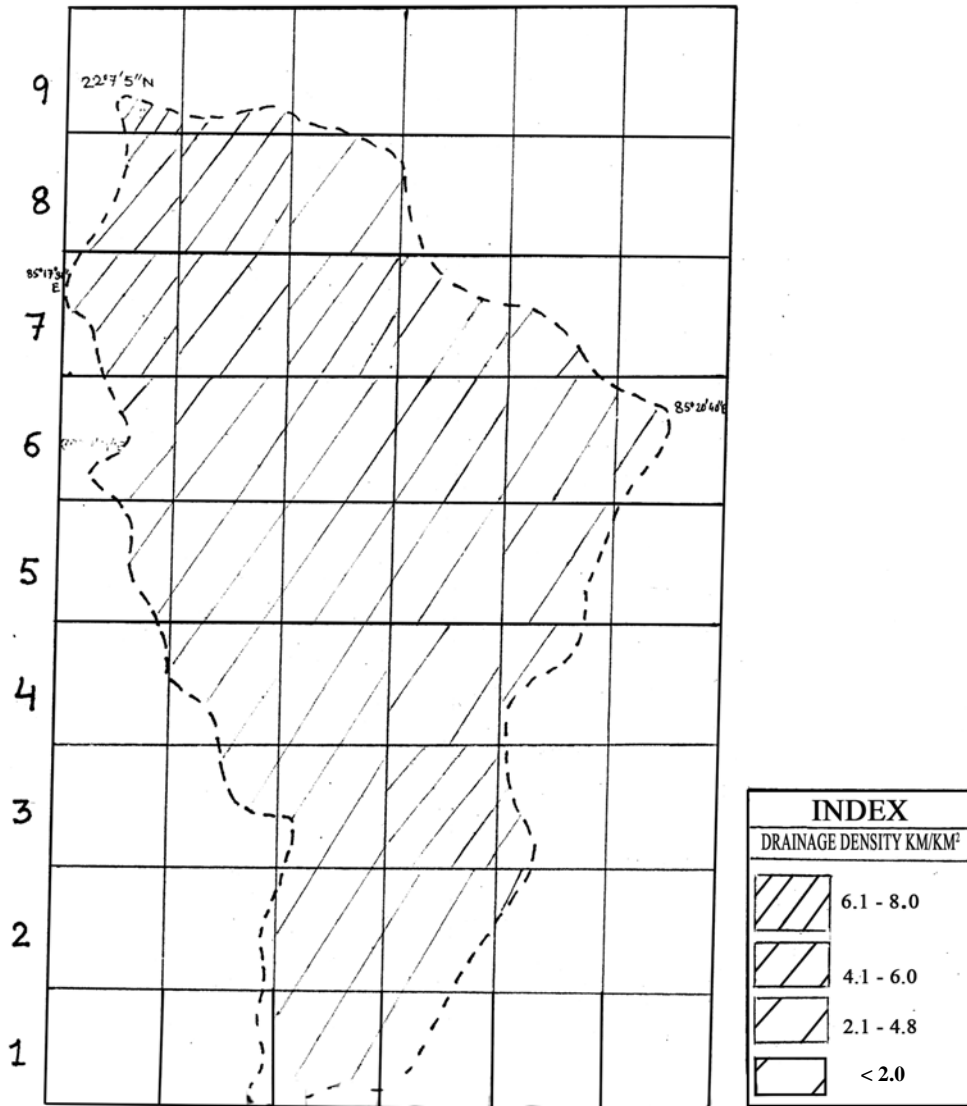

Table for Drainage Density and Stream Density

Grid No.	Length of stream on map(cm)	Actual length (km)	Area drained (Full grid/ a part)	Drainage Density (km/km²)	Number of Stream	Area drained (full grid/ a part)	Stream density (No of stream km²)
A ₅	1.5	0.75	0.19	3.45	2	0.19	10.5
A ₆	3.5	1.75	0.92	1.9	3	0.92	3.26
A ₇	9.5	4.75	0.83	5.72	7	0.83	8.43
A ₈	3.5	1.75	0.72	2.43	6	0.72	8.33
A ₉	2	1	0.13	7.69	2	0.13	15.39
B ₃	1	.5	0.22	2.27	2	0.22	9.09
B ₄	5	2.5	0.81	3.08	9	0.81	11.11
B ₅	6	3	1	3	7	1	7
B ₆	6	3	1	3	7	1	7
B ₇	7	3.5	1	3.5	8	1	8
B ₈	8.5	4.25	1	4.25	11	1	11
B ₉	1	.5	0.21	2.38	2	0.21	9.52
C ₁	5	2	0.81	2.46	7	0.81	8.64
C ₂	5	2.5	0.98	2.55	5	0.98	5.10
C ₃	5.5	2.75	0.93	2.95	6	0.93	6.45
C ₄	7.0	3.5	31	3.5	7	1	7
C ₅	.5	2.5	1	2.5	5	1	5
C ₆	5.5	2.75	1	2.75	8	1	8
C ₇	9	4.5	1	4.5	8	1	8
C ₈	0.5	0.25	1	0.25	3	1	3
D ₁	2.0	1	0.3	3.34	4	0.3	13.3
D ₂	4.0	2	0.75	2.63	5	0.7	6.57
D ₃	1.0	.5	1	5	9	1	9
D ₄	4.0	2	1	2	4	1	4
D ₅	5.0	2.5	1	2.5	6	1	6
D ₆	4.5	2.25	1	2.25	6	1	6
D ₇	4.5	0.6	0.88	2.25	6	0.88	6.82
E ₃	1	0.5	0.22	2.27	2	0.22	9.09
E ₄	0.5	0.25	0.24	1.04	2	0.24	8.33
E ₅	2.0	1	0.85	1.17	4	0.85	4.07
E ₆	6	3	1	3	5	1	5
E ₇	1	0.5	0.87	0.57	1	0.87	1.15
F ₆	0.5	0.25	0.24	1.04	2	0.24	8.33

4.1.8 Distribution of Stream Density

**DISTRIBUTION OF STREAM DENSITY
BY
CHOROPLETH METHOD
BAHADA DRAINAGE BASIN**

Map No. 73^F/₈

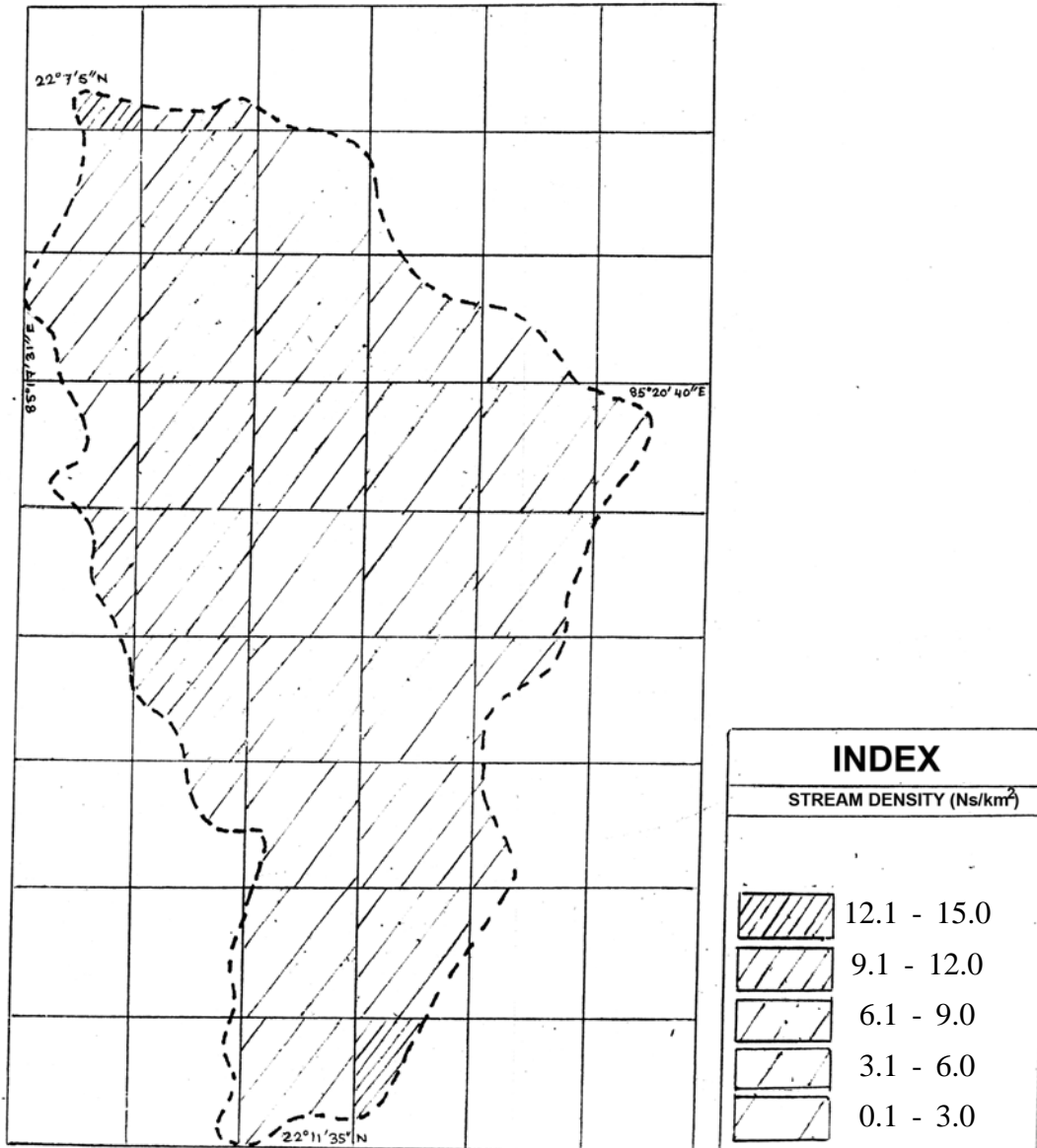

STREAM DENSITY

The morphological study of drainage basin has been done on the basis of Bahada drainage basin located in the State of Jharkhand. The stream is a tributary to the Kaina River. It is a non-perennial channel and the basin has a reasonable spread of stream network. Initially the basin boundary has been delineated along the ridge line. The maximum elevation marked in the basin is 868 mt., whereas the minimum is 340mt. contour near the confluence. The delineation of the basin has been done on the survey of India topographic sheet 73^F/₈ on 1:50,000 scale.

The basin has been grided by horizontal and vertical grids at an interval of 2 cm on map, that is 1 km on ground. The grids have been numbered by alpha-numeric method. Altogether 33 grids square have covered the basin and in the marginal areas. Sometimes a part of a grid has been taken into a consideration for area and other values.

Two different choropleth maps have been prepared from the generated data of stream density and drainage density. Stream Density (S.D.) is obtained as number of

streams/sq.km.:
$$S.D. = \frac{\text{No. of streams}}{\text{Area of grid}}$$

Drainage Density (D.D.) values have been obtained as length of stream in km/sq. km.

As per computed values of stream density it is 1.15 to 15.39. This range has been divided into a few discrete classes. Altogether 5 classes are obtained by screening method. It has been followed to indicate the variation of classes. It is observed that the central part of a stream has minimum to a medium range of values whereas the peripheral sections with higher relief have obtained higher values. Small tributaries have given higher stream densities. In a stream density map, the maximum range obtained 0.25 – 14.6 k.m./sq. km. This range divided into 4 classes as a regular interval of 3.0. Thus the following classes are obtained (0.1 – 3.0 Ns/km², 3.1 – 6.0 Ns/km², 6.1 – 9.0 Ns/km², 9.1 – 12.0 Ns/km², 12.1 – 15.0 Ns/km²)

The drainage density ranges from 0.25 to 7.69 km/km². The range has been divided into four discrete classes, like <2, 2.1 to 4.0, 4.1 to 6.0, 6.1 to 8.0 km/km². The northern and some central part of the basin has highest density value whereas the central to southern portion has the lower to medium density value.

4.2 Hypsometric Curve

4.2.1 Introduction :

Hypsometry (hypsos = height; metron = measure) is the measurement of the relationship between area and altitude of any area by drawing curve.

In the cartesian co-ordinates, area is plotted along the abscissa (x-axis) and altitude is plotted on the ordinate (y-axis). It is useful for the comprehension of area-altitude, distribution of any country, region or drainage basin. **Longbein** used such curve for the study of large watersheds whereas **Stralier** and others for small drainage basins.

4.2.2 Significance :

These curves are especially of tremendous significance for drainage basins as the areal distribution of the relief which is responsible for the development and alignment of drainage network, indicative of the stage of the erosional surface and slope pattern besides its significance of the potential energy of running water.

4.2.3 Types :

This curve can be of three types as follows :

1. Absolute hypsometric curve
2. Percentage hypsometric curve
3. Relative hypsometric curve

4.2.4 Drawing of the Hypsometric Curve :

The curve is used to show the proportion of the area of the surface at various elevation above or below a given datum. It should be drawn for an area having physical homogeneity. The area between each pair of contours (a) is expressed as a percentage of the total area of the region (A). The altitudinal variations (h) between the corresponding pair of contours is expressed as a percentage of the total relative relief (H) of the region. The hypsometric curve is obtained by plotting the $(h/H)\%$ on y-axis with respect to $(a/A)\%$ on x-axis. The shape and orientation of this curve graphically indicates the stage of the ensuing erosion cycle and the number of cycles already elapsed.

4.2.5 Advantages :

1. Actual assessment of the relief zones and their corresponding areal coverage of any drainage basin.
2. Detection of plateaus or erosional surfaces.
3. Assessment of the stage of the topography.
4. Useful for comparing the altitudinal distribution of different drainage basins.

4.2.6 Drainage Basin for calculation and drawing of hypsometric curve

CALCULATION SHEET FOR HYPSONETRIC CURVE

Altitude Class (m)	Area (a) (km ²)	Altitude/Height (h) (m)	a/A	h/H	Cumulatives	
					a/A	h/H
>400	0.48	60	0.06	0.25	0.06	0.25
300-400	0.41	100	0.05	0.42	0.11	0.67
<300	7.31	80	0.83	0.33	1.00	1.00

$$\Sigma a \text{ or } A = 8.20 \quad \Sigma h \text{ or } H = 240$$

Relative relief / height of that area is (highest contour – lowest contour value)

$$\left(\frac{a}{A}\right) = \frac{\text{Area between respective contours (a)}}{\text{Total area (A)}}$$

$$\left(\frac{h}{H}\right) = \frac{\text{Particular contour height (h)}}{\text{Total height of the area (H)}}$$

GALESERA RIVER BASIN

Map No. 73^B/₆

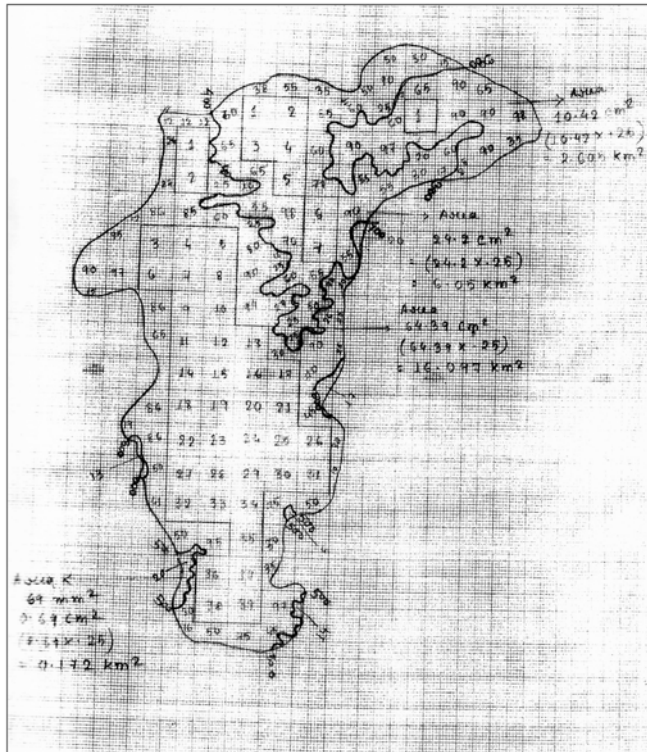

4.2.7 Hypsometric Curve [Drawing]

**HYPSONETRIC CURVE
OF
GALESERA RIVER BASIN**

MAP NO. 73^B/6

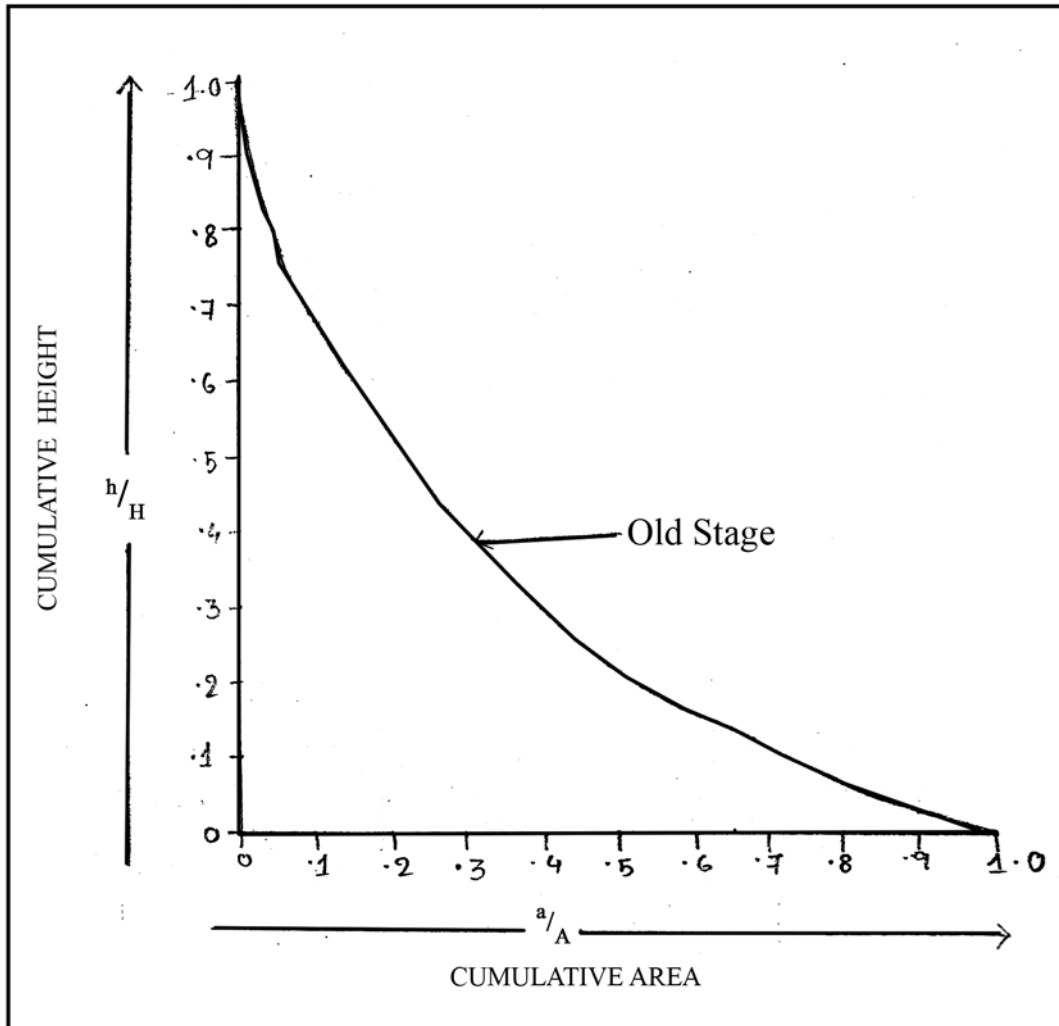

RF→1:50000

Unit 5 □ Megascopic Identification of Minerals and Rocks

Structure

5.1 Mineral samples: Bauxite, Calcite, Chalcopyrite, Feldspar, Galena, Gypsum, Hematite, Magnetite, Mica, Quartz, Talc, Tourmaline

5.1.1 Introduction

5.1.2 Definition of Minerals

5.1.3 Physical Characteristics

5.1.4 Some Major Minerals and their Characteristics

5.2 Rock samples: Granite, Basalt, Dolerite, Laterite, Limestone, Shale, Sandstone, Conglomerate, Slate, Phyllite, Schist, Gneiss, Quartzite, Marble

5.2.1 Introduction of Rocks

5.2.2 Definition of different types of rocks

5.2.3 Types

5.3 Rocks and Minerals in Brief [Identification and Characteristics]

5.3.1 Igneous Rock

5.3.2 Sedimentary Rocks

5.3.3 Metamorphic Rocks

5.3.4 Minerals

5.3.5 Minerals in Tabular Forms

5.3.6 Minerals in different arrangement

5.3.7 Very Heavy Minerals (Sp. Gr. above 6)

5.3.8 Colour of Minerals

5.3.9 Rocks in Details

5.3.10 Rocks in tabular form

5.1 Mineral samples: Bauxite, Calcite, Chalcopyrite, Feldspar, Galena, Gypsum, Hematite, Magnetite, Mica, Quartz, Talc, Tourmaline

5.1.1 Introduction :

The earth is composed of various kinds of elements and these elements are in solid form in the outer layer of the earth and in hot and molten form in the interior. About 98 per cent of the total crust of the earth is composed of eight elements like oxygen, silicon, aluminium, iron, calcium, sodium, potassium and magnesium (Table), and the rest is constituted by titanium, hydrogen, phosphorous, manganese, sulphur, carbon, nickel and other elements.

Table : The Major Elements of the Earth's Crust

Sl. No.	Elements	By Weight (%)
1.	Oxygen	46.60
2.	Silicon	27.72
3.	Aluminium	8.13
4.	Iron	5.00
5.	Calcium	3.63
6.	Sodium	2.83
7.	Potassium	2.59
8.	Magnesium	2.09
9.	Others	1.41

The elements in the earth's crust are rarely found exclusively but are usually combined with other elements to make various substances. These substances are recognised as minerals. Thus a mineral is a naturally occurring inorganic substance, having an orderly atomic structure and a definite chemical composition and physical properties. A mineral is composed of two or more elements. But, sometimes single element minerals like sulphur, copper, silver, gold, graphite etc. are found.

Though the number of elements making up the lithosphere are limited they are combined in many different ways to make up many varieties of minerals. There are at least 2,000 minerals that have been named and identified in the earth crust; but almost

all the commonly occurring ones are related to six major mineral groups that are known as major rock forming minerals.

The basic source of all minerals is the hot magma in the interior of the earth. When magma cools, crystals of minerals appear and a systematic series of minerals are formed in sequence to solidify so as to form rocks. Minerals such as coal, petroleum and natural gas are organic substances found in solid, liquid and gaseous forms respectively.

5.1.2 Definition of Minerals:

Mineral is an inorganic homogeneous substance usually crystalline with a definite chemical composition. Therefore minerals are natural body without organic particles.

Ex. Mica, Talc, Quartz, Feldspar, Gypsum, Hematite, Magnetite, Calcite, Chalcopyrite, Galena, Bauxite.

5.1.3 Physical Characteristics:

- (i) *External crystal form*—determined by internal arrangement of the molecules—cubes, octahedrons, hexagonal prisms, etc.
- (ii) *Cleavage*—tendency to break in given directions producing relatively plane surfaces—result of internal arrangement of the molecules—may cleave in one or more directions and at any angle to each other.
- (iii) *Fracture*—internal molecular arrangement so complex there are no planes of molecules; the crystal will break in an irregular manner not along planes of cleavage.
- (iv) *Lustre*—appearance of a material without regard to colour; each mineral has a distinctive lustre like metallic, silky, glossy etc.
- (v) *Colour*—some minerals have characteristic colour determined by their molecular structure—malachite, azurite, chalcopyrite etc. and some minerals are coloured by impurities. For example, because of impurities quartz may be white, green, red, yellow etc.
- (vi) *Streak*—colour of the ground powder of any mineral. It may be of the same colour as the mineral or may differ—malachite gives green streak, fluorite is purple or green but gives a white streak.
- (vii) *Transparency*—transparent; light rays pass through so that objects can be seen plainly; translucent—light rays pass through but will get diffused so that objects cannot be seen; opaque—light will not pass at all.

- (viii) *Structure*—particular arrangement of the individual crystals; fine, medium or coarse grained; fibrous—seperable, divergent, radiating.
- (ix) *Hardness*—relative resistance of being scratched; ten minerals are selected to measure the degree of hardness from 1-10. They are: 1. talc; 2. gypsum; 3. calcite; 4. fluorite; 5. apatite; 6. feldspar; 7. quartz; 8. topaz; 9. corundum; 10. diamond. Compared to this for example, a fingernall is 2.5 and glass or knife blade is 5.5.
- (x) *Specific gravity*—the ratio between the weight of a given object and the weight of an equal volume of water; object weighted in air and then weighted in water and divide weight in air by the difference of the two weights.

5.1.4 Some Major Minerals and their Characteristics

Feldspar : Silicon and oxygen are common elements in all types of feldspar and sodium, potasium, calcium, aluminium etc. are found in specific feldspar variety. Half of the earth's crust is composed of feldspar. It has light cream to salmon pink colour. It is used in ceramics and glass making.

Quartz : It is one of the most important components of sand and granite. It consists of silica. It is a hard mineral virtually insoluble in water. It is white or colourless and used in radio and radar. It is one of the most important components of granite.

Pyroxene : Pyroxene consists of calcium, aluminum, magnesium, iron and silica. Pyroxene forms 10 per cent of the earth's crust. It is commonly found in meteorities. It is in green or black colour.

Amphibole : Aluminium, calcium, silica, iron, magnesium are the major elements of amphiboles. They form 7 per cent of the earth's crust. It is in green or black colour and is used in asbestos industry. Hornblende is another form of amphiboles.

Mica : It comprises of potassium, aluminium, magnesium, iron, silica etc. It forms 4 per cent of the earth's crust. It is commonly found in igneous and metamorphic rocks. It is used in electrical instruments.

Olivine : Magnesium, iron and silica are major elements of olivine. It is used in jewellery. It is usually a greenish crystal, often found in basaltic rocks.

Besides these main minerals, other minerals like chlorite, calcite, magnetite, haematite, bauxite and barite are also present in some quantities in the rocks.

Metallic Minerals : These minerals contain metal and can be sub-divided into three types:

- (i) *Precious metals* : gold, silver, platinum etc.
- (ii) *Ferrous metals* : iron and other metals often mixed with iron to form various kinds of steel.
- (iii) *Non-ferrous metals* : include metals like copper, lead, zinc, tin, aluminium etc.

Non-Metallic Minerals : These minerals do not contain metal, Sulphur, phosphates and nitrates are examples of non-metallic minerals. Cement is a mixture of non-metallic minerals.

5.2 Rock samples: Granite, Basalt, Dolerite, Laterite, Limestone, Shale, Sandstone, Conglomerate, Slate, Phyllite, Schist, Gneiss, Quartzite, Marble

5.2.1 Introduction of Rocks :

The earth's crust is composed of rocks. A rock is an aggregate of one or more minerals. Rock may be hard or soft and in varied colours. For example, granite is hard, soapstone is soft. Gabbro is black and quartzite can be milky white. Rocks do not have definite composition of mineral constituents. Feldspar and quartz are the most common minerals found in rocks.

5.2.2 Definition of different types of rocks :

Definition of Rocks : Rock can be defined as a material made of mineral particles bonded together. Rock is a hard and clastic substance. Therefore, rocks are aggregate of minerals. Rocks are classified according to their origin—

- (a) **Igneous Rock** : The Latin word 'Ignis' means fire. Igneous rocks are actually of fiery origin. They are made by the cooling and solidification of hot molten material either magma within the earth's crust or the earth's surface.

Ex. Granite, Basalt, Dolerite. Igneous rocks are of two types— i) Extrusive rock ii) Intrusive rock.

- (b) **Sedimentary Rock** : The Latin word 'Sedere' means 'Setting down'. Deposition of eroded materials of pre-existing rocks by natural agents like river glacier, wind at distant places below the river, lake, sea or oceans under water in layers and solidification of these sediments (deposited particles) in layers form sedimentary rocks.

Ex. Coal, Shale, Sandstone, Limestone, Conglomerate, Laterite. Sedimentary rocks are either of classic or non-classic origin.

- (c) **Metamorphic Rock** : The Greek word ‘meta’ means ‘altered’ and ‘morpho’ means form. Due to temperature or pressure a pre-existing either igneous or sedimentary rock changes into a new form of rock which is called metamorphic rock.

Ex. Slate, Phyllite, Quartzite, Gneiss, Marble. Schist, metamorphic rock can be either foliated or non-foliated.

5.2.3 Types :

There are many different kinds of rocks which are grouped under three families on the basis of their mode of formation. They are: (i) Igneous Rocks—solidified from magma and lava; (ii) Sedimentary Rocks—the result of deposition of fragments of rocks by exogenous processes; (iii) Metamorphic Rocks—formed out of existing rocks undergoing recrystallisation.

Igneous Rocks : As igneous rocks form out of magma and lava from the interior of the earth, they are known as primary rocks. The igneous rocks (Ignis—in Latin means ‘Fire’) are formed when magma cools and solidifies. When magma in its upward movement cools and turns into solid form it is called igneous rock. The process of cooling and solidification can happen in the earth’s crust or on the surface of the earth.

Igneous rocks are classified based on texture. Texture depends upon size and arrangement of grains or other physical conditions of the materials. If molten material is cooled slowly at great depths, mineral grains may be very large. Sudden cooling (at the surface) results in small and smooth grains. Intermediate conditions of cooling would result in intermediate sizes of grains making up igneous rocks. Granite, gabbro, pegmatite, basalt, volcanic breccia and tuff are some of the examples of igneous rocks.

Sedimentary Rocks : The word ‘sedimentary’ is derived from the Latin word sedimentum, which means settling. Rocks (igneous, sedimentary and metamorphic) of the earth’s surface are exposed to denudational agents, and are broken up into various sizes of fragments. Such fragments are transported by different exogenous agencies and deposited. These deposits through compaction turn into rocks. This process is called *lithification*. In many sedimentary rocks, the layers of deposits retain their characteristics even after lithification. Hence, we see a number of layers of varying thickness in sedimentary rocks like sandstone, shale etc.

Depending upon the mode of formation, sedimentary rocks are classified into three major groups: (i) mechanically formed—sandstone, conglomerate, limestone, shale, loess etc. are examples; (ii) organically formed—geyserite, chalk, limestone, coal etc. are some examples; (iii) chemically formed—chert, limestone, halite, potash etc. are some examples.

Metamorphic Rocks : The word metamorphic means ‘change of form’. These rocks form under the action of pressure, volume and temperature (PVT) changes. Metamorphism occurs when rocks are forced down to lower levels by tectonic processes or when molten magma rising through the crust comes in contact with the crustal rocks or the underlying rocks are subjected to great amounts of pressure by overlying rocks. Metamorphism is a process by which already consolidated rocks undergo recrystallisation and reorganisation of materials within original rocks.

Mechanical disruption and reorganisation of the original minerals within rocks due to breaking and crushing without any appreciable chemical changes is called dynamic metamorphism. The materials of rocks chemically alter and recrystallise due to thermal metamorphism. There are two types of thermal metamorphism — contact metamorphism and regional metamorphism. In contact metamorphism the rocks come in contact with hot intruding magma and lava and the rock materials recrystallise under high temperatures. Quite often new materials form out of magma or lava are added to the rocks. In regional metamorphism, rocks undergo recrystallisation due to deformation caused by tectonic shearing together with high temperature or pressure or both. In the process of metamorphism in some rocks grains or minerals get arranged in layers or lines. Such an arrangement of minerals or grains in metamorphic rocks is called *foliation* or *lineation*. Sometimes minerals or materials of different groups are arranged into alternating thin to thick layers appearing in light and dark shades. Such a structure in metamorphic rocks is called *banding* and rocks displaying banding are called *banded rocks*. Types of metamorphic rocks depend upon original rocks that were subjected to metamorphism. Metamorphic rocks are classified into two major groups—foliated rocks and non-foliated rocks. Gneissoid, granite, syenite, slate, schist, marble, quartzite etc. are some examples of metamorphic rocks.

2.2.4 Rock Cycle : Rocks do not remain in their original form for long but may undergo transformation. Rock cycle is a continuous process through which old rocks are transformed into new ones.

Igneous rocks are primary rocks and other rocks (sedimentary and metamorphic)

form from these primary rocks. Igneous rocks can be changed into metamorphic rocks. The fragments derived out of igneous and metamorphic rocks form into sedimentary rocks. Sedimentary rocks themselves can turn into fragments and the fragments can be a source for formation of sedimentary rocks. The crustal rocks (igneous, metamorphic and sedimentary) once formed may be carried down into the mantle (interior of the earth) through subduction process (parts or whole of crustal plates going down under another plate in zones of plate convergence) and the same melt down due to increase in temperature in the interior and turn into molten magma, the original source for igneous rocks.

5.3 Rocks and Minerals in Brief

[Identification and Characteristics]:

Identifying Characteristics :

In case of Rocks : 1. Colour, grain size, specific gravity 2. Mineral composition, special character.

In case of minerals : 1. Colour, Luster, Specific gravity 2. Hardness, special characteristics.

Testing Instruments

- a) Glass
- b) Streak plate
- c) Magnet
- d) Knife (steel)
- e) Acid (HCl)
- f) Magnifying glass

Lustr

- a) Vitreous—Broken glass
- b) Pearly—Lustre of a pearl
- c) Earthy—soil like
- d) Silky—smooth
- e) Metallic—metal like

Hardness

- a) Nail—0 < 2.5
- b) Steel Knife—5.5
- c) Iron knife—5.0
- d) Glass plate—6.0

Special Character

- a) Reaction with HCl
- b) Magnetic attraction
- c) Streak plate
- d) Smell Power
- e) Feel Power

5.3.1 Igneous Rock

Granite:

- i) Light coloured with spots of white, pink and black. Moderate to coarse grained, moderate to high specific gravity.
- ii) Composed of quartz, feldspar, mica. It is a hard, compact, massive.

Basalt:

- i) Dark black/grayish black, very fine grained, moderate to high specific gravity.
- ii) Composed of pyroxene, biotite. It is hard massive and compact.

Dolerite:

- i) Dark coloured, moderate grained, moderate to high specific gravity.
- ii) Composed of pyroxene, feldspar. It is hard, massive and compact have interfingering texture.

IGNEOUS AND SEDIMENTARY ROCKS

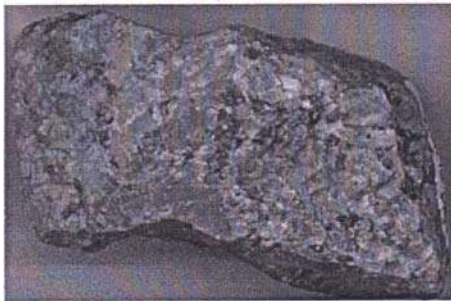

Granite



Basalt

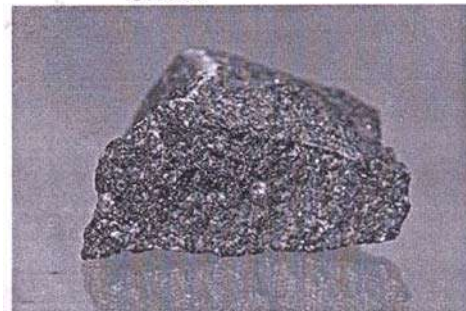

Dolerite

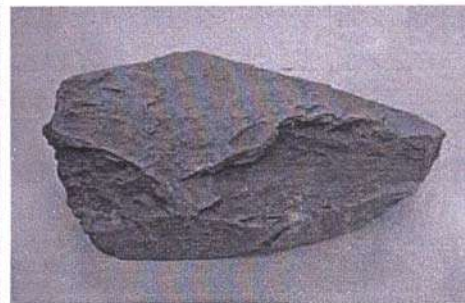

Shale

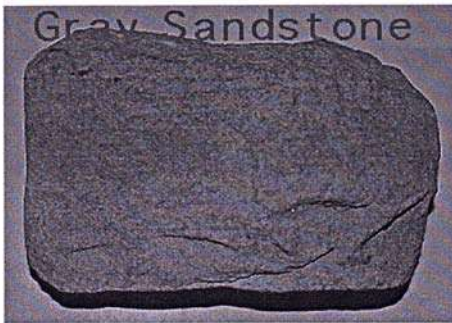

Sandstone

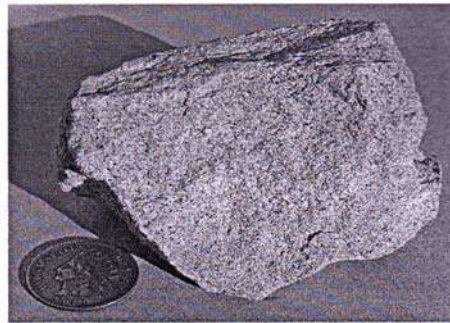

Sandstone



Limestone

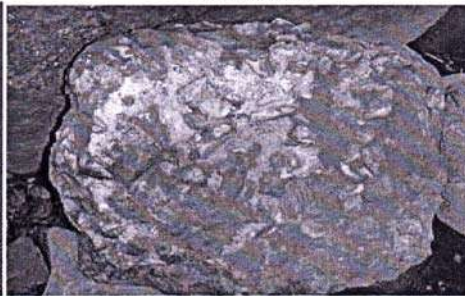

Conglomerate

SEDIMENTARY AND METAMORPHIC ROCKS



Laterite

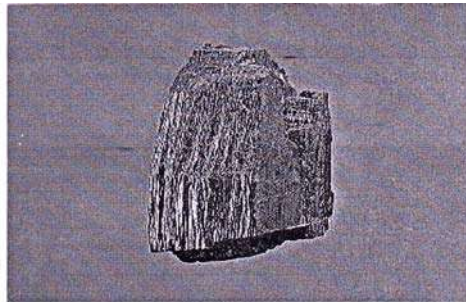

Slate



Phyllite

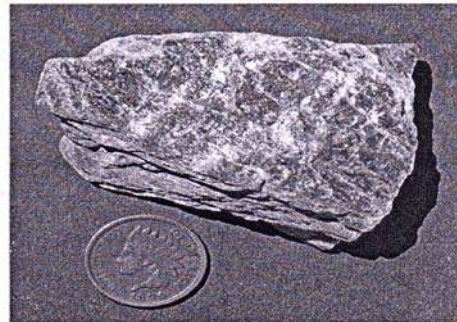

Phyllite



Schist



Marble



Quartzite

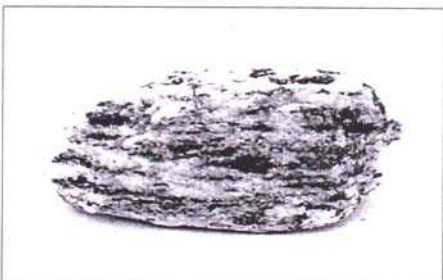

Gneiss



Gneiss



Gneiss



Granite (Different Colours)

5.3.2 Sedimentary Rocks

Shale:

- i) Yellowish green/Grey/Brown/Greenish brown. Very fine grain size, moderate specific gravity.
- ii) Composed of clay minerals, gives smell of clay when water is applied, it is non clastic rock.

Sandstone:

- i) White, light yellowish white, mixture, reddish brown medium to fine grain, moderate specific gravity.
- ii) Composed of sand and quartz, clastic surface, rough surface.

Limestone:

- i) Black/Grey/Greyish white/Mixture/Reddish Brown, medium to fine grain, moderate specific gravity.
- ii) Composed of calcite, non clastic and reacts with HCl, can be scratched by knife.

Conglomerate:

- i) Yellowish brown/White/Pinkish white, coarse grain, moderate specific gravity.
- ii) Composed of pebbles, sand/quartz, clastic texture.

Laterite:

- i) Brown, orange, reddish brown, red, medium grained, moderate to high specific gravity.
- ii) Composed of bauxite, limestone, quartz, vesicular structure with spots of nodules, clastic rock, very rough surface.

5.3.3 Metamorphic Rocks

Slate:

- i) Greenish black/Grey, fine grained, moderate specific gravity.
- ii) Composed of clay, prominent foliation, gives metallic sound under Hammer blow.

Phyllite:

- i) Greenish grey/Grey/Green, moderate specific gravity.
- ii) Composed of chlorite and mica, foliated rock, fine to medium grain size.

Quartzite:

- i) White/Ash/Grey/Brownish grey, low to medium grained, low to moderate specific gravity.
- ii) Composed of sand, quartz sharp edge, non foliated.

Gneiss:

- i) Alternate band of light and dark colored, medium grained, moderate specific gravity.
- ii) Composed of mica, quartz and feldspar, non foliated.

Marble:

- i) White/Pink, orangish white, fine to medium grained, low to moderate specific gravity.
- ii) Composed of lime stone, react with HCl, non foliated.

Schist:

- i) Silver/White/Black/Green, medium grained, low to moderate specific gravity.
- ii) Composed of muscovite biotite chlorite, foliated rock, crystalline, quartz, feldspar.

5.3.4 Minerals

Talc:

- i) White/Whitish grey/Grey, silky luster, low specific gravity.
- ii) Less than 2.5, soapy feeling

Mica:

- a) **Muscovite** —
 - i) Colour white, silver, pearly luster, very low specific gravity.
 - ii) Hardness < 2.5, transparent and translucent mineral.
- b) **Biotite** —
 - i) Black coloured, pearly luster, very low specific gravity.
 - ii) Hardness < 2.5, transparent and translucent mineral.

Gypsum:

- i) White/Grey colored, sub-pearly luster, low specific gravity.
- ii) Hardness < 2.5, translucent mineral.

Quartz:

- i) White/Greyish white, vitreous lustre.
- ii) Hardness 6, crystalline mineral.

Feldspar:

- a) **Albite/Plagioclase** — i) White/Grey, sub pearly luster, high to moderate specific gravity.
ii) Hardness > 5, 2D Cleavage.
- b) **Orthoclase** — i) Reddish white/Pink color, sub pearly lustre, high to moderate specific gravity.
ii) Hardness > 5, 2D (Cleavage

Hematite:

- i) Reddish brown (outer surface), Black inner surface, sub metallic luster, very high specific gravity.
- ii) Hardness 5.5 to 6.5, very low magnetism, gives cherry red streak.

Magnetite:

- i) Iron black colored, submetallic to earthy luster, high specific gravity.
- ii) Hardness 5.5 to 6.5, highly magnetism, gives black streak.

Calcite:

- i) White colored, vitreous luster, low to moderate specific gravity.
- ii) 3D Cleavage, react with HCl.

Bauxite:

- i) Creamy/Whitish cream/Grey/Earthy lustre, low to moderate specific gravity.
- ii) Non crystalline mineral, Pisolitic masses.

Minerals

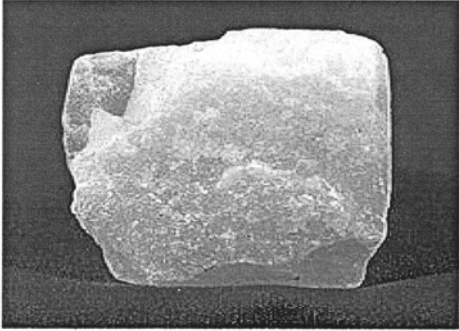

Talc

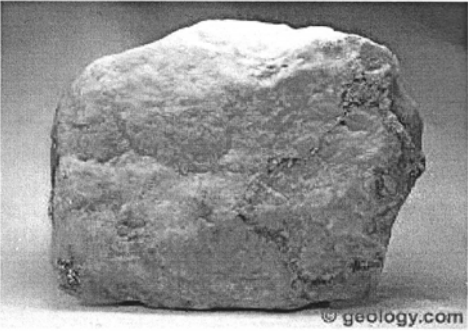

Gypsum

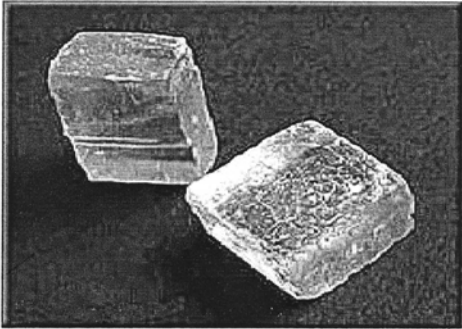

Calcite

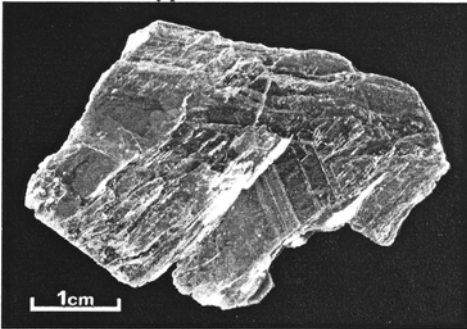

Mica

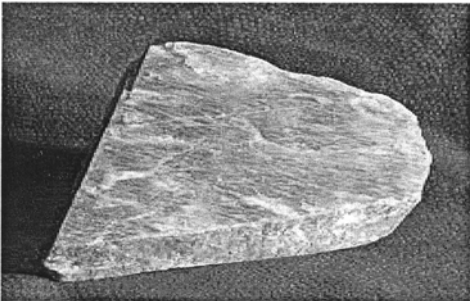

Feldspar

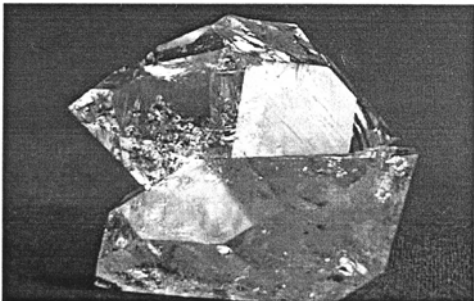

Quartz

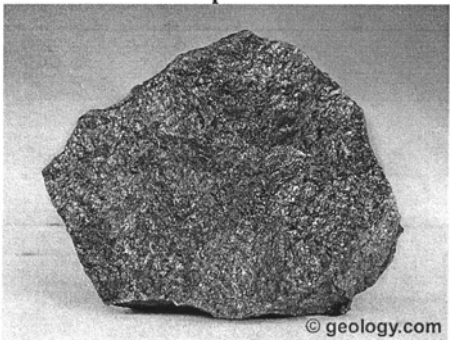

Chalcopyrite

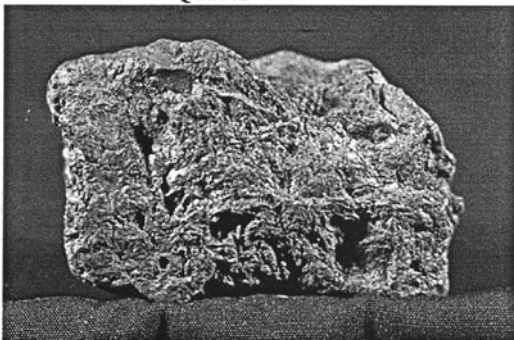

Hematite

Chalcopyrite:

- i) Golden yellow/yellow/Green, metallic luster, high specific gravity.
- ii) Hardness > 3.5 to 4, Greenish black streak, gives smell when HCl is applied.

Galena:

- i) Steel black/Iron black colored, metallic luster, very high specific gravity.
- ii) Hardness > 5.5, lead grey streak.

Tourmaline:

- i) Silver or greenish black coloured, metallic lustre moderate specific gravity.
- ii) Hardness > 6, prismatic crystals with rounded shape.

Igneous or Sedimentary Rocks

Shale
 Sandstone
 Granite
 Limestone
 Coal

Metamorphic Rocks

Slate
 Quartzite
 Gneiss
 Marble
 Graphite

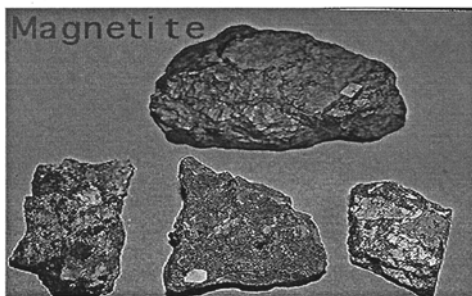

Magnetite



Bauxite

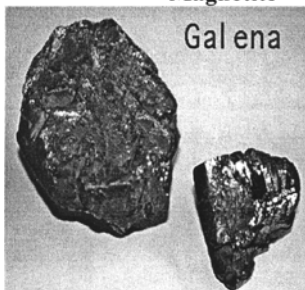

Galena

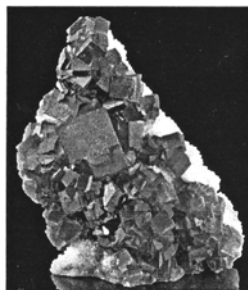

Galena



Galena

5.3.5 Minerals in Tabular Forms

MINERAL	TYPE	COLOUR	LUSTRE	SPECIFIC GRAVITY	HARDNESS	SPECIAL CHARACTER
1. Mica	Biotite	Silvery black	Pearly	very low	less than 2.5	transparent, translucent 2 set cleavage
	Muscovite	Silvery white				
2. Quartz		Greyish white, white (variable)				
3. Feldspar	Orthoclase	Pink	Pearly	Moderate	5-6	2 set cleavage
	Plagioclase	White (Variable)				
4. Galena		Silvery grey	Metalic	Very High	5-6	Greyish Black Streak, Smell of Gun Powder
5. Talc		Off	Silky	Low to moderate	Less than 2.5	Soapy feel

		white, white, Greyish white (variable)		moderate		
6. Gypsum		Silvery white, Silver grey (variable)	Pearly	Low to moderate	Below 2.5	Waxy, transparent, translucent
7. Haematite		Cherry red (Outer surface), lead black (inner surface)	Metallic	Very high	5-6	Cherry red/brown streak, very low Magnetised
8. Magnetite		Black, greyish black (variable)	Metallic/ sub- metallic	Very high	5-6	Lead black streak, gets attracted by magnet
9. Bauxite		Red, Pink, Reddish brown (variable)	Earthy	Moderate to high	5-6	Nodular, pisolitic structure
10. Chalcopyrite		Greenish black, grey golden (variable)	Metallic	Moderate	5-6	Greenish black streak
11. Calcite		White, greyish white (variable)	Pearly	Moderate to low	2.5 to 5	3 set of cleavage, Rhombohedral shape, reacts with HCl
12. Tourmalin		Silvery Black, Greenish black	Metallic	Moderate	More than 6	Prismatic Crystals with rounded shape

5.3.6 Minerals in different arrangement

Mineral	Sp. Gr.	Mineral	Sp. Gr.
Olivine	3.2–4.3 (6-7)	Hornblende	3.3–4.7 (5-6)
Topaz	3.5–3.6 (8)	Realgar	3.56 (1.5-2)
Kyanite	3.5–3.7 (4-7)	Strontianite	3.6–3.7 (3.5-4)
Limonite	3.6–4 (5-5.5)	Staurolite	3.7 (7-7.5)
Azurite	3.7–3.8 (3.5-4)	Siderite	3.7–3.9 (3.5-4.5)
Psilomelane	3.7–4.7 (5-6)	Malachite	3.9–4 (3.5-4)
Corundum	3.9–4.1 (9)	Sphalerite	3.9–4.2 (3.5-4)
Garner	3.9–4.2 (6.5-7.5)	Smithsonite	4–4.5 (5.5)
Chalcopyrite	4.1–4.3 (3.5-4)	Barite	4.5 (3-3.5)
Stibnite	4.5–4.6 (2)	Chromite	4.5–4.8 (5.5)
Zircon	4.7 (7.5)	Molybdenite	4.7–4.8 (1-1.5)
Pyrolusite	4.8 (2-2.5)	Pyrite	4.8–5.1 (6-6.5)
Haematite	4.9–5.3 (5.5-6.5)	Magnetite	5.18 (5.5-6.5)
Zincite	5.4-5.7 (4-4.5)	Cuprite	5.8–6.15 (3.5-4)
Arsenopyrite	5.9–6.2 (5.5-6)		

5.3.7 Very Heavy Minerals (Sp. Gr. above 6)

Cuprite	5.8–6.15 (3.5-4)	Wolframite	7.1–7.9 (5-5.5)
Arsenopyrite	5.9–6.2 (5.5-6)	Cobalite	6–6.3 (5.5)
Bismuthinite	6.4–6.5 (2)	Cerussite	6.55 (3-3.5)
Classiterite	6.8-7.1 (6-7)	Argentite	7.19–7.36 (2-2.25)
Niccolite	7.3–7.6 (5-5.5)	Galena	7.4-7.6 (2.5)
Cinnabar	8.09 (2-2.5)	Native Copper	8.8 (2.5-3)

5.3.8 Colour of Minerals

The minerals can also be arranged according to their common colours. The arrangement followed here is a modification of Warner's scheme.

I. Metallic Colour:

- i) Copper red—native copper.
- ii) Brass yellow—chalcopyrite.
- iii) Silver white—arsenopyrite.
- iv) Tin white—cobalite.

- v) Lead gray—galena, molybdenite.

II. Non-Metallic Colours

A. *White*

- i) Reddish, yellowish or grayish white—calcite, quartz.
- ii) Greenish white—talc.
- iii) Milk-white—slightly Bluish—some chalcedony.

B. *Gray*

- i) Green gray—talc.

C. *Black*

- i) Velvet black—black tourmaline.
- ii) Greenish black—augite.
- iii) Bluish black—black cobalt.

D. *Blue*

- i) Blackish blue—azurite.
- ii) Azure blue—a clear shade of bright blue—azurite.
- iii) Violet blue—blue mixed with red—fluorite.
- iv) Prussian blue—pure, blue—Kyanite.
- v) Smalt blue—some gypsum.
- vi) Indigo blue—blue with black and green tourmaline.

E. *Green*

- i) Verdigris green—green, inclining to bluesome feldspar.
- ii) Celandine green—green, white blue and gray—talc and beryl.
- iii) Mountain green—green, with much blue—beryl.
- iv) Grass green—green, with more yellow-green diallage.
- v) Pistacho green—light green with some brown epidote.
- vi) Asparagus green—yellowish green—apatite.
- vii) Blakish green—serpentine.
- viii) Oil green—olive oil colour—beryl.

F. *Yellow*

- i) Sulphur yellow—sulphur.
- ii) Straw yellow—pale yellow—topaz
- iii) Wax-yellow—brownish gray yellow—sphalerite, opal.
- iv) Honey—yellow, with shads of brown and red—calcite.
- v) Lemon yellow—sulphur, orpiment.

- vi) Ochre—yellow—brownish—yellow—yellow ochre.
- vii) Wine-yellow—topaz and flourite.
- viii) Cream yellow—kaolinite.
- ix) Orange yellow—orpiment.

G. *Red*

- i) Aurora red—red with much yellow—some realgar.
- ii) Hyacinth red—red with shades of brown and yellow—garnet.
- iii) Scarlet red—red with a tinge of yellow—cinnabar.
- iv) Blood—red—garnet.
- v) Rose—red—rose quartz.
- vi) Brownish red—limonite.

H. *Brown*

- i) Reddish brown—garnet, zircon.
- ii) Wood-brown—some asbestos.

5.3.9 Rocks in Details

Rocks are the units of the earth's crust and are composed of minerals. A rock may be formed of only one mineral or it may be composed of several minerals. In popular conception the term rock is associated with something hard and heavy but in scientific usage a soft clay is as much a rock as the hard granite.

Genetically the rocks may be classified into three major groups. *viz.* (i) Igneous, (ii) Sedimentary and (iii) Metamorphic.

i) Igneous Granite : These are mostly commonly massive rocks without showing any tendency of foliation and banding. When metamorphosed they are banded or foliated and are more properly called granite-gneiss. The granites are a completely crystalline rock without any glassy matter and the texture varies from fine to coarse. Mineralogically they are composed chiefly of quartz, feldspars, and accessories like biotite muscovite, hornblende, other ferromagnesian minerals and iron oxides. These rocks are named according to the most prominent accessories as biotite-granite, hornblende-granite, etc. In hand specimen the quartz, feldspar and the chief accessories can be distinguished with the help of a pocket lens. In colour the granites are commonly of shade of gray but pink or red varieties also occur frequently. The colour of the rock depends on the proportion of the feldspars to the ferromagnesian minerals and also the colour of the feldspar itself. The specific gravity of the rock varies from 2.63

to 2.75 according to the proportion of the light and heavy minerals. In case of a graphic granite a beautiful inter growth is seen between quartz and feldspars.

Pegmatite: These occur as dykes or veins in the plutonic rock masses or as marginal segments to such plutonic mass but are characterized by the presence of large crystals of, say, quartz, feldspars, mica, etc. They also contain minerals which require volatile matter in their formation. e.g., tourmaline, fluorite, topaz, etc. and compounds of rare minerals like lepidolite, beryl, etc.

Syenite: It is completely crystalline rock and resembles granite in appearance but it contains very little or no quartz. In colour it varies from nearly white to light or deep gray, but pink syenites are also not uncommon. The rock is massive and evenly granular. Banding of foliation may be caused due to metamorphism. Mineralogically the typical rock is composed of alkali feldspars, hornblende, with accessories of plagioclase, apatite, magnetite and a little or no quartz. In mica-syenite the hornblende is replaced by biotite and in augite-syenite, augite is the chief ferromagnesian mineral. In nepheline-syenite nepheline is present along with feldspars. The specific gravity of the rock varies from 2.6 to 2.8 depending on the kind and proportion of minerals.

Diorite: It is completely crystalline even to coarse granulated rock. It is generally massive but may be foliated due to metamorphism. The constituent minerals are chiefly plagioclase, with little or no quartz and hornblende along with other ferromagnesian minerals as accessories. Sometimes one of these accessories like augite or biotite might occur in large quantities. The colour of the rock varies from shades of dark green to almost black. Since the proportion of ferromagnesian minerals is higher than in case of granite or syenite the rock has a darker colour and a heavier specific gravity varying from 2.85 to 3.0.

Gabbro: These are massive even granular rocks typically made up of some of the plagioclases and pyroxenes. Some of these show original banded structure which might get pronounced by metamorphism. The colour varies from dark gray, greenish to black but amphibolites are sometimes white or light coloured. Their specific gravity is a little higher than diorites varying from 2.9 to 3.2.

Peridotite: These rocks are without feldspar and are made up entirely of ferromagnesian minerals. They are crystalline, massive and sometimes show a mottled appearance (due to poikilitic texture). They are generally dark coloured varying from some shades of green (dunite) to complete black. They are heavier than gabbros and the specific gravity varies from 3 to 3.3.

Dolerite: It is dark, heavy, finely crystalline dyke rock. Typically it is composed of labradorite, augite and iron oxides, sp. gr. 2.64 to 3.12.

Basalts: The basalts are very common volcanic rocks and the term covers many varieties. These are basic lavas in which plagioclase feldspars and the ferromagnesian minerals occur in almost equal proportions. There may be a little quartz and alkali feldspar also. The ferromagnesian mineral is either augite or olivine and iron oxide. Sometimes hornblende or biotite also occur. In colour the basalts vary from gray black to black and rather dull in appearance. Gellular and amygdaloidal structures are common and less frequently the rock is porphyritic showing large crystals of plagioclase in a fine ground mass. The specific gravity is high varying from 2.9 to 3.1.

Rhyolite: It is the volcanic equivalent of granite. The texture is generally porphyritic, *i.e.*, large crystals of quartz and orthoclase embedded in a partly crystalline or glassy ground mass. *Obsidian* is the pure glassy variety with a bright vitreous lustre. It is jet black to red colour and has conchoidal fracture. Many *pitchstones* have a rhyolitic composition and show homogeneous glassy mass with a dull or resinous lustre. The colour varies from black to red brown or green. The specific gravity varies from 2.30 to 2.70.

Pumice: It is an extremely porous and cellular glassy rock. The colour is generally white or gray but darker varieties also occur.

Title: These rocks have been formed by the denudation of pre-existing rocks and the deposition and consolidation of the denuded material in water or air. The sedimentary rocks are characterized by stratification.

ii) Sandstone: It is a rock made up of sand grains held together by some cementing materials like silica, iron oxide or lime. Some sandstones contain little cementing substance and their tenacity is due to the pressure during the time of consolidation. Apart from sand the minor constituents are feldspar, mica, garnet, magnetite, etc. The size of the grains varies very widely. In the fine grained types the sand particles are generally angular but in the coarser varieties the sand particles are well rounded. Bedded or cross-bedded structures are well marked. The colour varies widely from gray, white buff, brown to red depending primarily on the colour of the cementing material.

Shale: These are finely stratified rocks and are compacted muds, clays or silts. Sometimes the shales are so finely stratified that each laminae is no thicker than a

sheet of paper. Apart from clay which is chiefly kaolin the shales contain varying proportions of sand and also calcareous matter and with the increase in the proportion of sand degrade into fine grained sandstone and with increase of calcareous matter they pass into limestone. Most shales are soft and disintegrate into small fragments. These occur in various shades of colour—gray, buff, yellow, red, brown, purple, green or black.

Limestone: It is a widely distributed rock and is chiefly composed of calcite with varying proportions of silica or clay as impurities. In grain size it varies from a finely granular rock to a rock composed of coarse fragments of shells and corals. The rock shows a wide range of colours. It is white when pure and impure varieties vary from gray to black. The rock can be easily scratched with a knife and it effervesces in cold dilute hydrochloric acid. The specific gravity of the rock varies from 2.5 to 2.8.

Breccia: A rock composed of cemented stone fragments. The fragments are angular and typically do not show any stratification. These fragments may be of any kind of rock. The colour of the rock varies widely depending on the constituents.

Conglomerate: This rock is entirely of an aqueous origin. It consists of rounded water-worn pebbles cemented together. The size of the pebbles varies widely. The pebbles may be entirely of one rock but more commonly they are fragments from different rocks. The colour and texture present a heterogeneous appearance.

iii) Metamorphic: These rocks were originally sedimentary or igneous and their present state is due to a change brought about by intense heat and/or pressure.

Quartzite: These are chiefly formed by the metamorphism of sandstone. It is fine to coarse grained rock and is hard and compact. The colour varies widely—white, gray, yellowish, greenish or reddish. Broken surfaces show vitreous lustre and conchoidal fracture.

Slate: It is a fine grained hard and dense rock derived chiefly from the metamorphism of shales. The rock is cleavable into very thin laminae. The cleavage surface may be lustrous or dull, smooth or complicated but sometimes are also knotty due to grains of pyrite or magnetite. The colour is generally gray to black but red, purple or green slates also occur. The specific gravity is about 2.75.

Marble: It is a metamorphic form of limestone. The rock is massive and has generally an even-grained texture. The endless varieties of coloured marble are due to the presence of impurities in the original rock. Black marbles are produced from

bituminous limestone. The red, brown and yellow varieties are due to disseminated iron compounds.

Gneiss: It is compact, completely crystalline, coarsely foliated rock. The darker bands are composed of ferromagnesian minerals and the light bands are commonly a mixture of quartz and feldspar. These bands may be regular or curved and contorted. The lines may be continuous or short and penticular. The colour varies from white through shades of gray, red, brown, green to nearly black. The rocks are named either according to chief ferromagnesian mineral as hornblende-gneiss, biotite-gneiss, augite-gneiss, etc., or after the parent rock as granite-gneiss. syen.te-gneiss. etc.

Schists: There are characterised by marked foliation along which they split readily. The rocks are completely crystalline and individual minerals are large enough to be visible, but sometimes the grain size is very fine. The colour varies widely according to the ferromagnesian minerals: mica-schists-may be gray to brown, chlorite-schists—shades of green, hornblende-schists—from green to black; talc-shists—light white to pale green or gray.

Phyllite: These also show a slaty cleavage but are characterised by the presence of mica and the latter gives the rock a silvery appearance. Sometimes the cleavage face is knotted by crystals of garnet, quartz, pyrite. etc.

5.3.10 Rocks in tabular form :

A. Grained, constituent grains recognized—Mostly intrusive				
	(a) Feldspathic rocks, usually light in colour		(b) Ferromagnesian rock, generally dark to black in colour	
	with quartz without quartz with subordinate feldspar, without feldspar			
Non- Porphyritic	Granite (a) Aplite	Syenite (a) Syenite (b) Nepweline syenite (c) Anorthosite	Diorite Gabbro- Dolerite	Peridotite Pyrozenite Hornblendite
Porphyry	Granite Porphyry	Syenite Porphyry	Diorite Porphyry	

**B. Dense, constituents nearly or wholly unrecognizable—
Intrusive and Extrusive**

(a) Light, colour, usually Feldspathic (b) Dark coloured to black, usually
ferromagnesian

Non- Porphyritic	Felsite	Basalt
---------------------	---------	--------

Porphyritic	Felsiteporphyry	Basalt-porphyry
-------------	-----------------	-----------------

C. Rocks composed wholly or in part of glass—Extrusive

Non-porphyritic obsidian, pitchstone, perlites, pumice, etc.

Porphyritic vitrophyre (obsidian and pitchstone porphyry)

Fragmental Igneous material—Extrusive

Tuffs, Breccias (volcanic ashes, etc.)

Unit 6 □ Measurement of dip and strike using Clinometer

Structure

6.1 Introduction

6.2 Measurement

6.3 Method

6.4 Example

6.1 Introduction

The clinometer is an optical device for measuring elevation, angles above horizontal. With the help of this instrument, we can easily measure the dip and strike of any rock. This is mostly used to determine the dip and strike of the rock or rock structure to prepare geological or geomorphological maps.

6.2 Measurement

The dip and strike of any rock strata can be easily measured with the help of a compass (for measuring direction of dip & strike) and a clinometer (for reading angle of dip). These two are usually combined in a **compass clinometer**.

Dip: The inclination of a bedding plane with respect to the horizontal plane is called dip.

Strike: The direction perpendicular to the direction of true dip is called a strike and a line drawn in this direction is called a **strike line**.

6.3 Method

The measurement of dip and strike using clinometer needs to follow the following steps—

- a) Set the clinometer so that 90° and 270° on the dial are lined up with the markers on the clinometer and the inner scale reads 0° when the instrument is horizontal.
- b) Then, place the clinometer on the bedding plane and move it around until a reading of 0° is obtained.
- c) Draw a soft pencil line on the bedding plane to mark where the base of the clinometer rests on the rock. Since this line is horizontal, it will show the direction of dip.

Clinometer

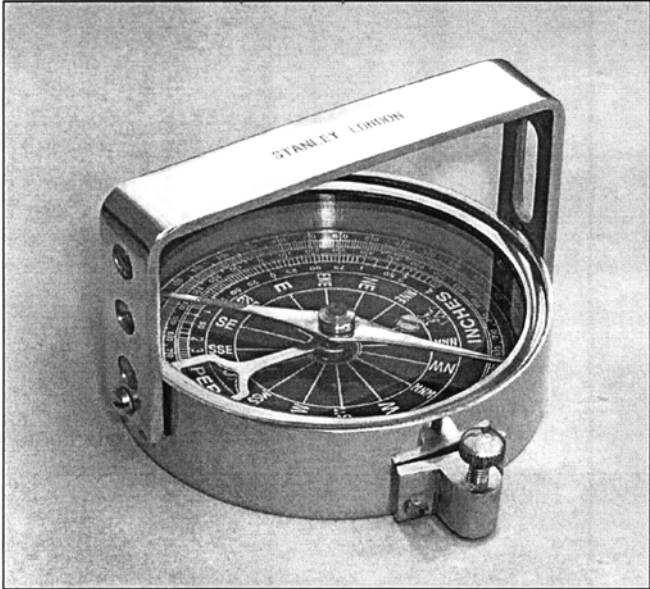

Clinometer

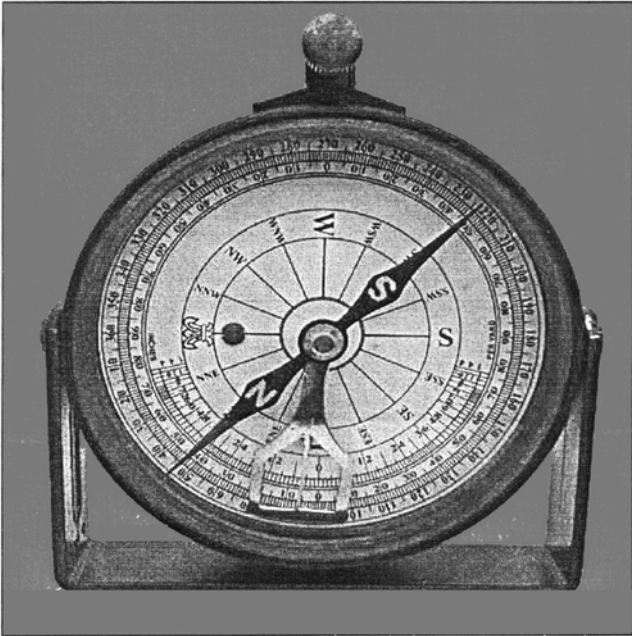

- d) Draw a another line on the rock so that it is a right angle to the direction of strike and points directly down the sloping bedding plane. This line marks the director of dip.
- e) Using a compass measure the direction of strike and the direction of dip, as shown by the lines drawn on the rock.
- f) Record the grid reference of the location, the strike direction in degrees and the dip direction in degrees.

6.4 Example

The slope of land in degrees can be found with the help of a clinometer. As already explained, if the slope is 1° a Vertical Interval (V.I.) of 1 foot corresponds to a Horizontal Interval (H.I.) of 57.3 feet, or about 20 yards, so that we get the relation:

$$\text{H.I.} = \frac{20 \times \text{V.I.}}{D}$$

Where D = degree of slope.

If a land with uniform slope of 5° is to be contoured at vertical intervals of 10 feet then the H.I. will be $= \frac{20 \times 10}{5} = 40$ yards. That is the contour lines are to be drawn 40 yards apart. In other words the land rises 10 feet vertically in a horizontal distance of 40 yards. To minimise calculation a scale can be prepared for a given V.I. to show H.I. corresponding to different degrees of slope.

Supposing a hillock is to be contoured at 10 feet interval with a clinometer. First, one contour line is established round the eminence a little below the summit at a distance less than 10 feet. To level a line round the hill marking the position of the first contour a piece of cloth is tied round a ranging rod at a height equal to the height of the eye of the observer with the clinometer. The ranging rod is moved about and with the clinometer at zero a number of positions are fixed by noting the cloth mark on the rod.

Unit 7: Preparation and Interpretation of Simple Geological Maps

Unit 7 □ Preparation and Interpretation of Simple Geological Maps

Structure

7.1 Concept

7.2 Related Concepts

7.3 Formula

7.4 Geological Time Scale

7.5 Information Displayed by Geological Maps

7.6 Use of Geological Maps

7.7 Criterias for Interpretation of Geological Maps (Horizontal, Uniclinal and Simple Anticlinal and Synclinal Fold Structure)

7.8 Interpretation of Geological Maps

A) Example 1

B) Example 2

C) Example 3

D) Example 4

E) Example 5

F) Example 6

G) Example 7

H) Example 8

I) Example 9

J) Example 10

K) Example 11

7.1 Concept

The map which show the geographical/geological pattern of the composition of the earth's surface by means of lithology, structure and succession of geological formations. It represents the outcrop of the different rock strata of a particular region.

7.2 Related concepts

- 1) **Lithology:** It shows the precise location and extend of the different outcrops or underline rock beds.
- 2) **Succession:** The chronological sequence of rockbeds is called succession.
- 3) **Unconformity:** It denotes the discontinuity in the succession.
- 4) **Structure:** It denotes the altitude of the rock beds which represents the relation between outcrop pattern and contour layout.
- 5) **Outcrop:** The intersection of a rock body with the topography is called outcrop.
- 6) **Bedding plane:** It is the plane that separates two successive rock beds or strata or layers. It may be upper and or lower bedding plane.
- 7) **Dip:** The inclination of a bedding plane with respect to the horizontal plane is called dip. It is two types—
 - (a) **True dip:** It is measured along the direction of maximum inclination/slope of an inclined plane.
 - (b) **Apparent dip:** It is measured in any direction other than the direction of maximum slope.

[True dip is always equal or greater than apparent dip.]
- 8) **Strike:** The direction perpendicular to the direction of true dip is called the **strike** and line drawn in this direction is called a **strike line**. (It is also known as 'stratum contours' or 'structure contours')
- 9) **Dip direction:** It is the geographical direction in which the beds dip is called the dip direction.

- 10) **Thickness:** It is the differences of upper and lower surface of a bed. It is two types—
- (a) **Vertical thickness:** The vertical distance between upper and lower surface of the bed.
 - (b) **True thickness:** It is the perpendicular distance between the upper and lower surfaces of the bed.
- 11) **Horizontal structure:** In it the bedding planes run parallel to the contours [No strike line and dip become zero]
- 12) **Uniclinal structure:** This structure is formed when all the beds in a series dip uniformly in a particular direction.
- 13) **Folded structure:** In it repetition of outcrops and reversal and variation of dip signified syncline or anticline or a combination of two—
- (a) **Syncline:** The two limbs dip towards the axial plane.
 - (b) **Anticline:** The two limbs dip away from the axial plane.

7.3 Formula:

- 1) True dip (θ) = $\tan^{-1} \left[\frac{\text{Strike difference}}{\text{Perpendicular Strike Intercept}} \right]$
- 2) Apparent dip (α) = $\tan^{-1} \left[\frac{\text{Strike difference}}{\text{Strike Interception Section Line}} \right]$
- 3) Vertical thickness (V_v) = Measure vertical distance between bedding planes by scale. ($w \cdot \tan \theta$)
- 4) True thickness (Tt) = vertical thickness (Vt) $\cdot \cos \theta$

7.4 GEOLOGICAL TIME SCALE

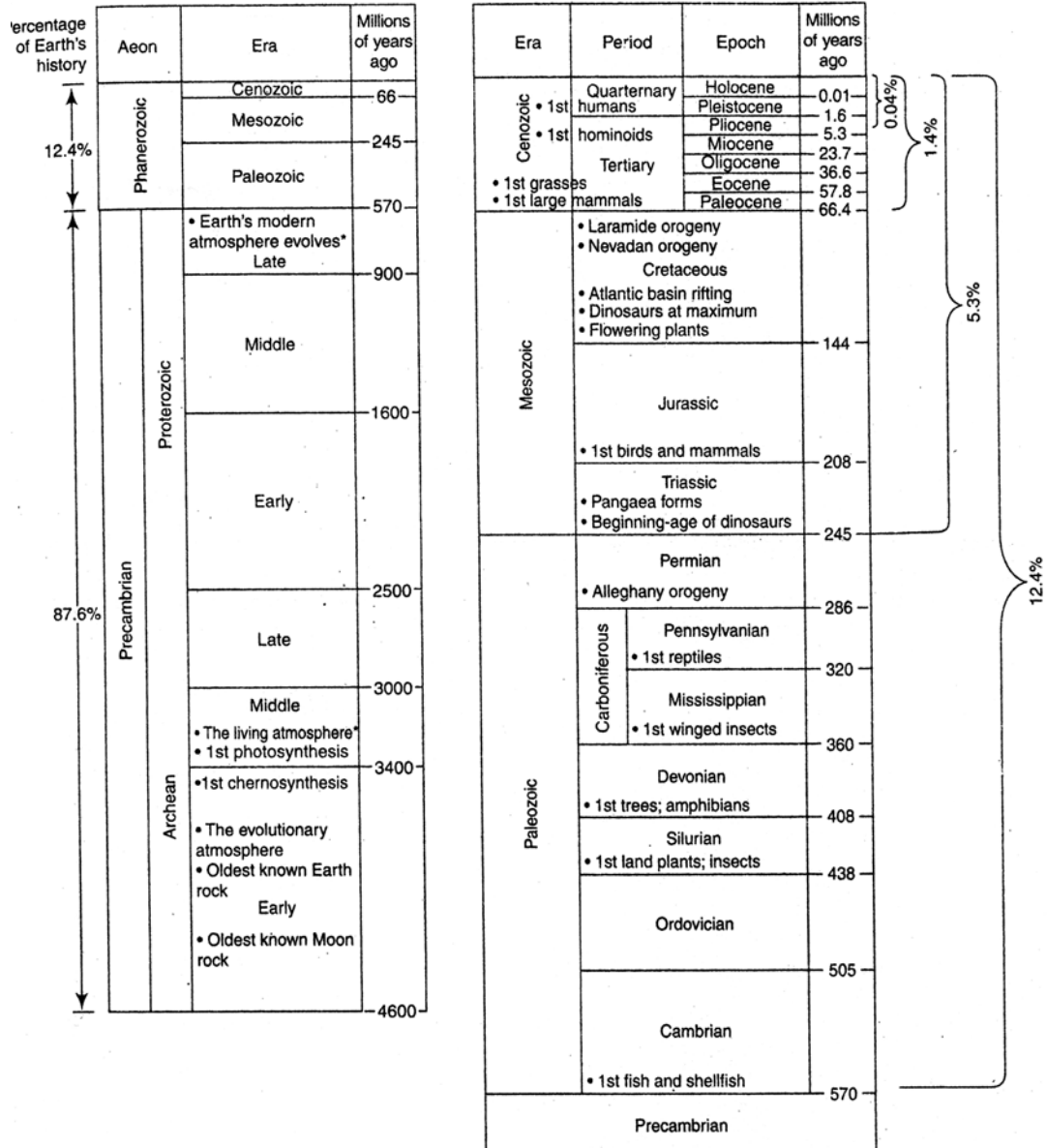

(In case of geological map interpretation, the geological time scale is necessary)

7.5 Information displayed by Geological maps

Geological map is a two-dimensional representation of patterns of lithological boundaries in relation to topography and structure. It is the one which shows the occurrence and distribution of rocks as ground surface. Geological maps are produced at various scales and may show different types of informations like folds, faults. Others are designed for economic purposes and give specialised informations on mineral deposit. They display the following information.

- a) The distribution of rock and position of the boundaries them.
- b) The key usually gives the stratigraphical position and name of the rock.
- c) Thickness of beds.
- d) The various structural elements features such as the dips of the strata, position of faults and their throw may be shown accordingly in the map.
- e) Informations may be given on some map on particular some fossils banks and localities of some features of economic importance for eg. the outcrop of mineral veins and coal seams.

7.6 Use of Geological Maps

Geological maps are used to interpret the structure, stratigraphy, mineralogy, paleontology and historical records of the earths crust. It is used to locate source of groundwater, mineral sources and energy resource. Also geological maps are used to describe and identify certain potential mineral hazards such as Mercury, Randon etc.

Geological map constitute a fundamental objective, scientific foundation on which water use and resource use decisions are made and based. It is the best science product to display the information that decision makers used to identify and protect valuable resources avoid risks from natural hazards and make wise use of our land. They are used to identify potential geological hazards such as landslides, earthquakes, and areas susceptible to Tsunamis. Geological maps are used by landuse planners to identify and determine the areas which are suitable for agriculture and urban development.

7.7 Criterias for Interpretation of Geological Maps

Visual Identification of structures:

- Unconfirmity:**
- (a) Bedding plants of the older series appear to end abruptly covered by the beds of younger beds/series.
 - (b) Strike was on two sides intersect and beds have different altitudes.

Horizontal structure: Contours run parallel to the bedding planes.

Vertical structure: Bedding planes cut across the contours such that the inner strike distance in zero (usually denoted by a cross).

Uniclinal structure: Contours and outcrop intersect one another.

Folded structure:

- a) Outcrops repeat on either side of the core beds.
- b) The outcrops combine to form either X or H pattern.
- c) If younger beds form core, it is a syncline, and if older beds form a core it is an anticline.

Faulted structure:

- a) A fault is indicated by a thicker line on the either side of which bedding planes are displaced.
- b) A straight fault trace indicates a vertical fault and curved fault trace indicates inclined fault.

Fold: a) Rock strata may be bent or folded into a series of troughs or downfolds or arches or upfold due to horizontal compressional forces.

- b) The imaginary surface about which folding occurs is axial plane of fold.
- c) The line along which the change in direction of dip occurs is called the axis of folding.
- d) The beds on either side of fold is called limbs.
- e) The fold in which limb dip towards the axial plane is a syncline.
- f) The fold in which limbs dip outward or away from the axial plane is an anticline.
- g) The fold is symmetrical where limbs equally dip and vice versa.

Fault:

a) A rock series may be broken or fractured due to stresses setup in the Earth's crust by the tectonic forces and they are accompanied by dislocation or relative movement of strata on either side, the rocks are said to be faulted, fracture called fault and surface called fault plane. The angle of fault is called heave and displacement is called throw. There are upthrown and downthrown sides of a fault.

7.8 Interpretation of Geological Maps

Example 1 :

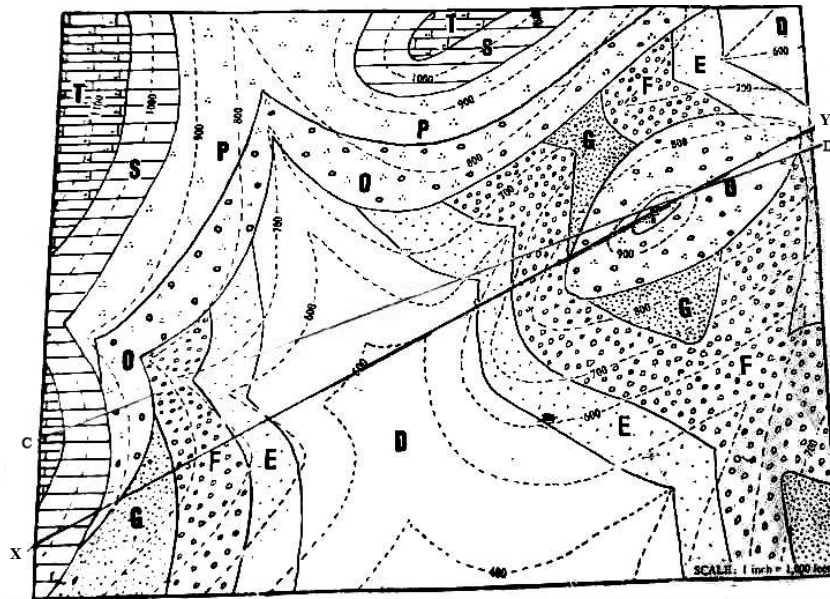

Scale: 1" = 1000 feet



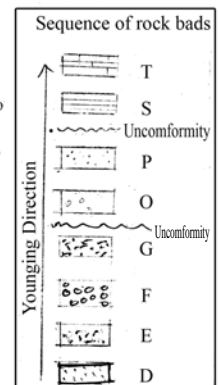
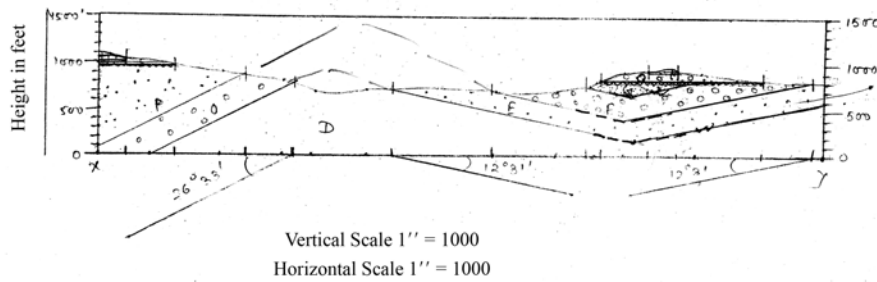



Geological Cross Section Along The Line xy



INTERPRETATION

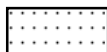

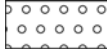
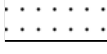

Introduction: A section line XY is drawn through the central part of the map running in west to east direction and the map has H.S.—1" = 1000 feet and V.S.—1" = 1000 feet. This is a three series map.

a) **Succession of rock beds:** The sequence of rock beds is called succession of rock beds. The map consists of three series. The oldest bed of older series is lower D and after that the other beds are deposited in sequential order. The oldest beds of older series are lower D, E, F, G, O, P. The youngest beds of younger series are upper T, S, P, O.

Name of rock beds	Symbol	Age of Deposition	Thickness (feet)		Remarks
			True	Vertical	
upper T		Youngest ↑	98	199	Younger
upper S			049	50	
lower p		↓ Oldest	49	50	Unconformity
lower O			98	100	Unconformity
lower G			148	150	Older
lower F			248	250	
lower E		248	250		
lower D		693	700		

b) **Geological Structure:** The upper part of the map is horizontal structure and the beds are upper T and S. There is a unconformity line between upper S and lower P. The middle part of the map is anticline fold above which a valley is exist and its related beds are lower P, O, S and F. It's core bed is lower D and it's oldest bed of older series. It's right dip angle is 26°33' towards west and left dip angle is 12°31' towards east. The lower part of the map also is syncline fold and its core bed is lower

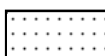
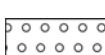
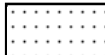
G, above which a ridge is exist. Its left dip angle is $12^{\circ}31'$ towards west and left dip angle is also $12^{\circ}31'$ towards east.

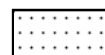
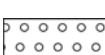
Name of rock beds	Symbol	Age of Deposition	Dip (degree)		Remarks
			Apparent	True	
upper T		Youngest	$0^{\circ}0'$	$0^{\circ}0'$	Horizontal Structure Unconformity
upper S			„	„	
lower p			$26^{\circ}33'$	$33^{\circ}41'$	Anticlinal Valley Unconformity
lower O			„	„	
lower G		Oldest	$12^{\circ}31'$	$14^{\circ}2'$	Synclinal ridge
lower F			„	„	
lower E			„	„	
lower D			„	„	

c) Topography and its relation with structure: The map area reaches its highest altitude of 1100 feet towards the left and right margin of the map section and the lowest altitude of the areas is 500 feet. The lower altitude is find in the central part of the map. The relative or altitudinal variation in the region is almost 600 feet.

The general slope of the map is from west to central and east to central part of the map. Fluvial action has been affecting the topography leads to a river valley where the rivers have formed and the rivers flowing from three direction from the higher to lower altitude teading to a centripetal drainage pattern. Moreover here, consequent, subsequent, strike, dip and anti-dip streams form a trellis drainage pattern. It indicates that there is no structural control over topography. However, due to such drainage pattern a typical topographic features called inversion of relief topography with a hillocks near the western part. Therefore, it signifies a folded topography of both anticlinal and synclinal by nature.

d) Geological History: The geological sequences are—

1) All the rock beds are of sedimentary origin, so all of them develop in marine condition.

2) Here the oldest bed in D which was first deposited, the subsequently E, F, G beds were deposited in the same series.

3) After that, in a separate series O and P beds are deposited.

4) After the deposition they were uplifted and tilted and due to tectonic movement, folded topography is formed.

5) Finally, S and T beds are deposited and due to tectonic movement, they formed folded topography and then they are subjected to erosional deposition.

6) Different drainage network constantly evolve the region and Inversion of topography is formed.

B) Example 2 :

GEOLOGICAL MAP

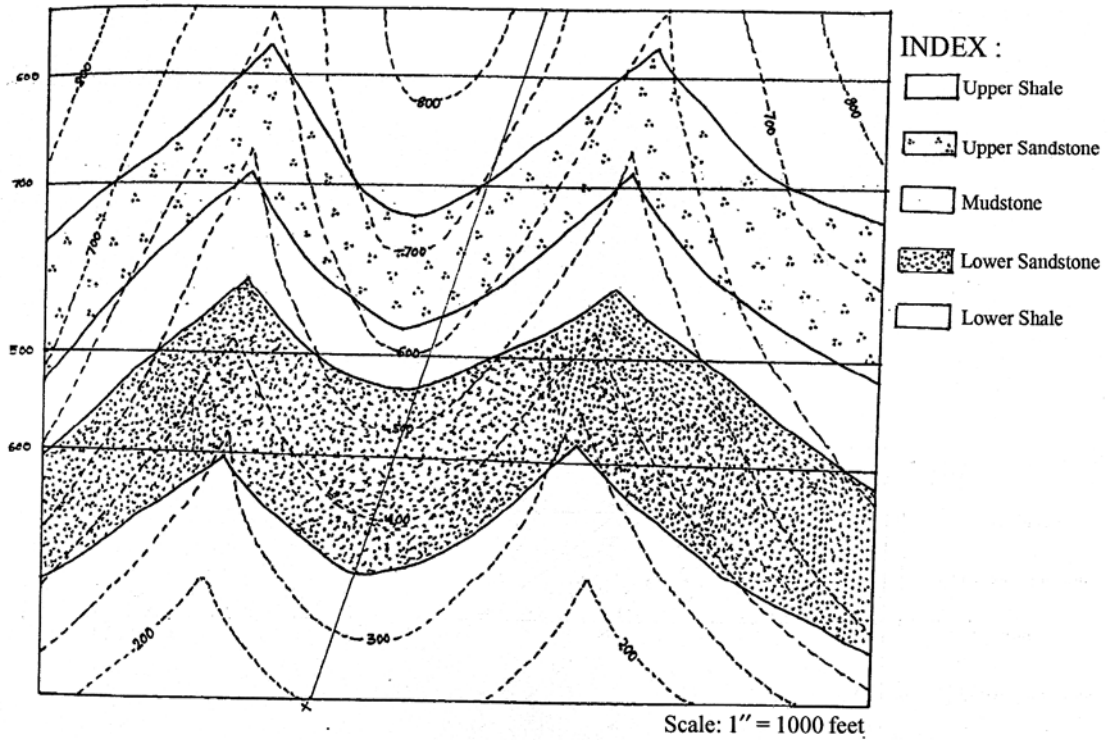

GEOLOGICAL SECTION ALONG XY

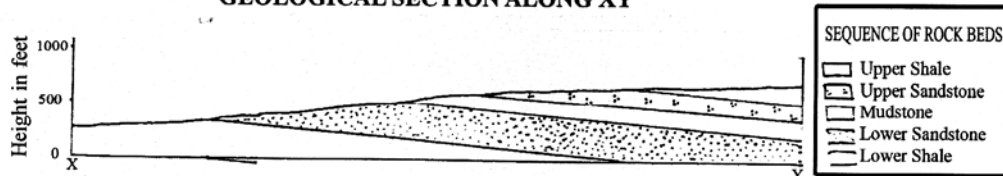

INTERPRETATION

Geological Map is a systematic representation of structure layout of different geological beds within the limits of contour alignment of a particular area on a certain scale. The section is drawn on the basis of the given map (example 2) which is located (xy) southwest to northeast. The nature of contour and topographical pattern indicates a plateau region.

Succession of Geological beds:

Beds	Thickness (feet)		Remarks
	V. T.	T. T.	
Upper scale	> 50	150.82	Youngest
Upper Sandstone	200	201.10	↑ Oldest
Mudstone	200	201.10	
Lower Sandstone	350	351.92	
Lower Shale	< 500	301.45	

V.T. → Vertical thickness T.T. → True thickness.

The sequence of beds is given. From the table we can see that upper shale is the youngest bed while lower shale forms the oldest bed. From this, we also use get the sequence of super position of beds. It is a single series formation.

Structure:

Beds	Dip Amount		Remarks
	T.D.	A.D.	
Upper Shale	6°0'	5°42'	Uniclinal Structure
Upper Sandstone	”	”	
Mudstone	”	”	
Lower Sandstone	”	”	
Lower Shale	”	”	

T.D. → True Dip

A.D. → Apparent Dip

The structure is an uniclinal structure with an angle of Dip as 6°0' (True dip) and 5°42' (Apparent dip). The sedimentary series being of the same series are conformable to each other.

Topography: The Region is of a plateau terrain. The maximum height of 800 feet is in the eastern part of the section while the lowest height of 200 feet is in the western side of the section thus covering a relative relief of 600 feet. Two consequent streams are flowing from N to S.

Topography in relation with structure: The topographical dip and structural dip is inversely related thus they are negatively related. Thus erosion varies in this region. On the western side, strike valley or antidip valley is formed.

Geological History:

Sedimentary beds are formed under marin conditions in the order lower shale, lower sandstone, mudstone, upper sandstone, upper shale order. Deposition is taken place by upliftment and then lifting of rock strata and their subaerial erosion and denudation.

C) Example 3 : Geological map and cross sectional profile

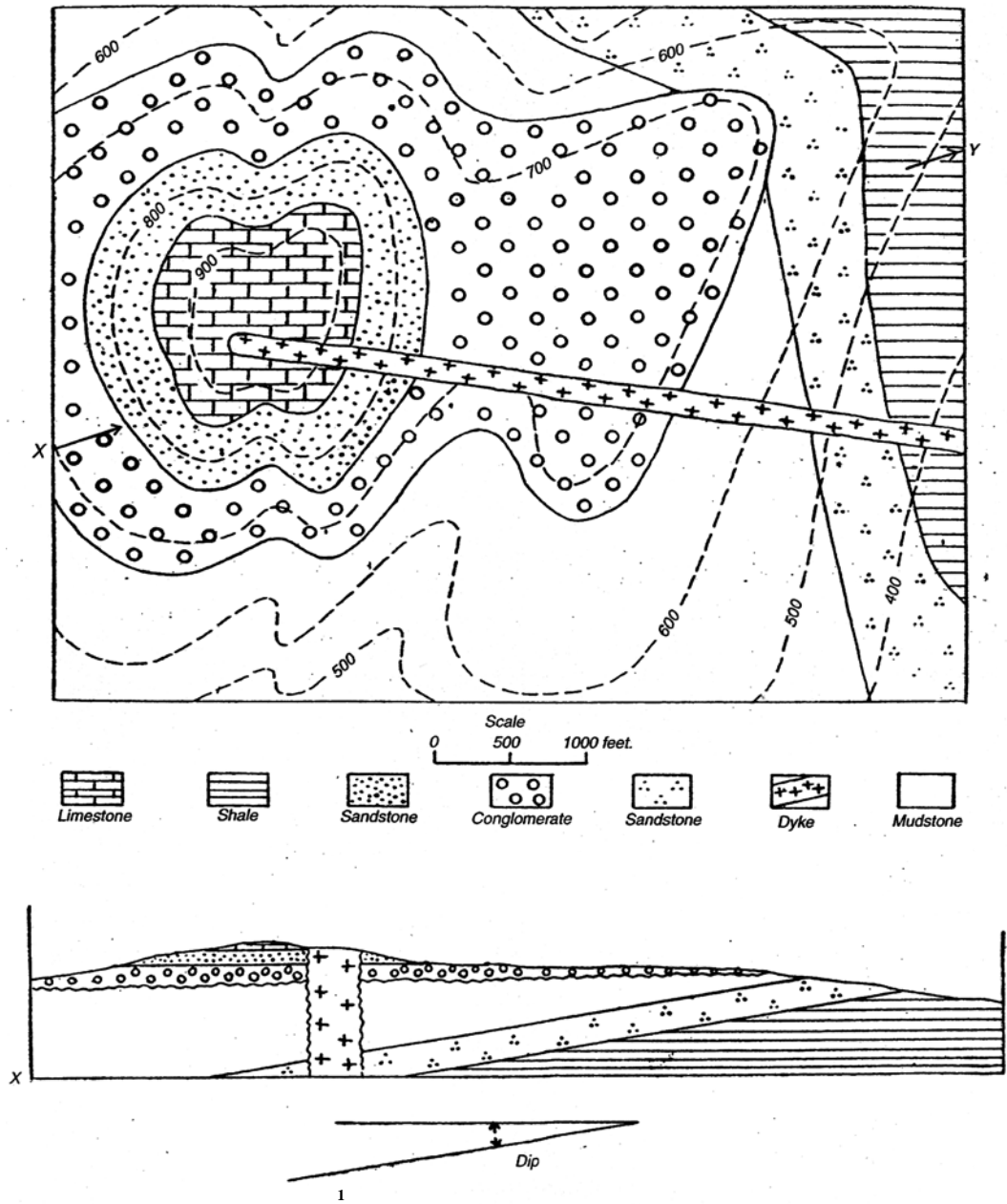

D) Example 4 :

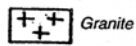
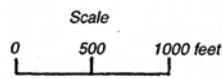
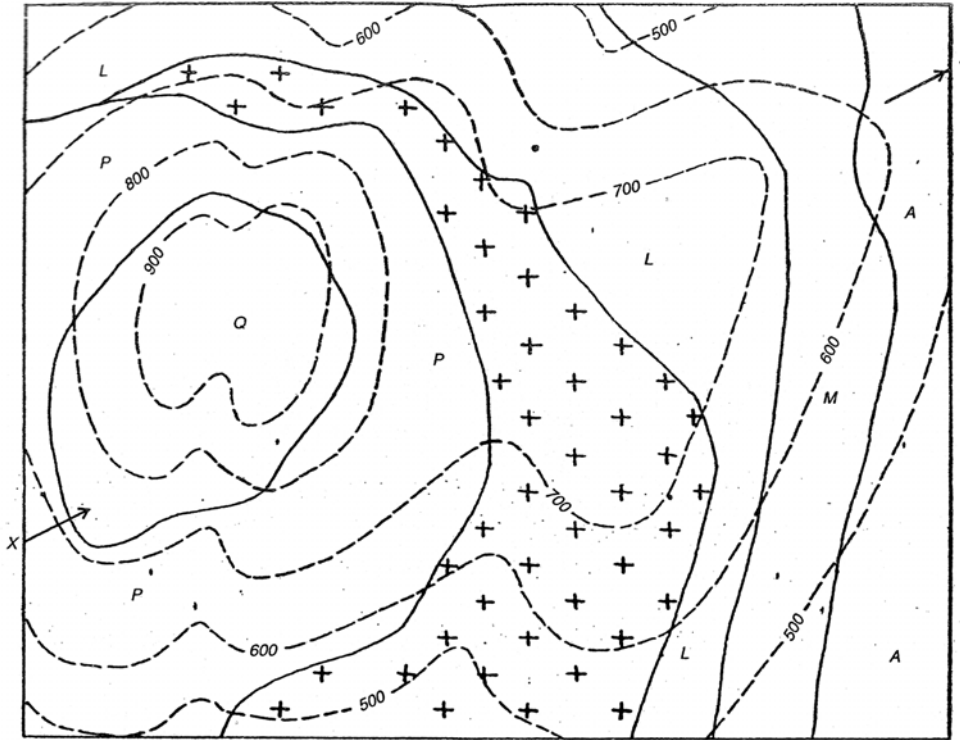

Map No. 2 Example (ii)

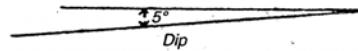
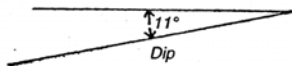
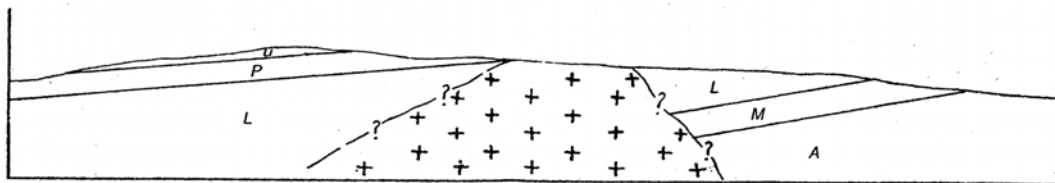
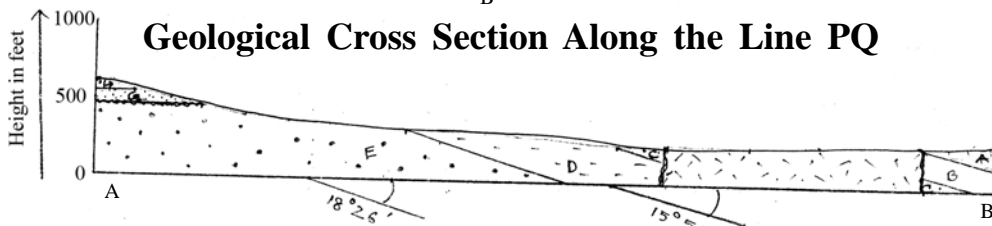
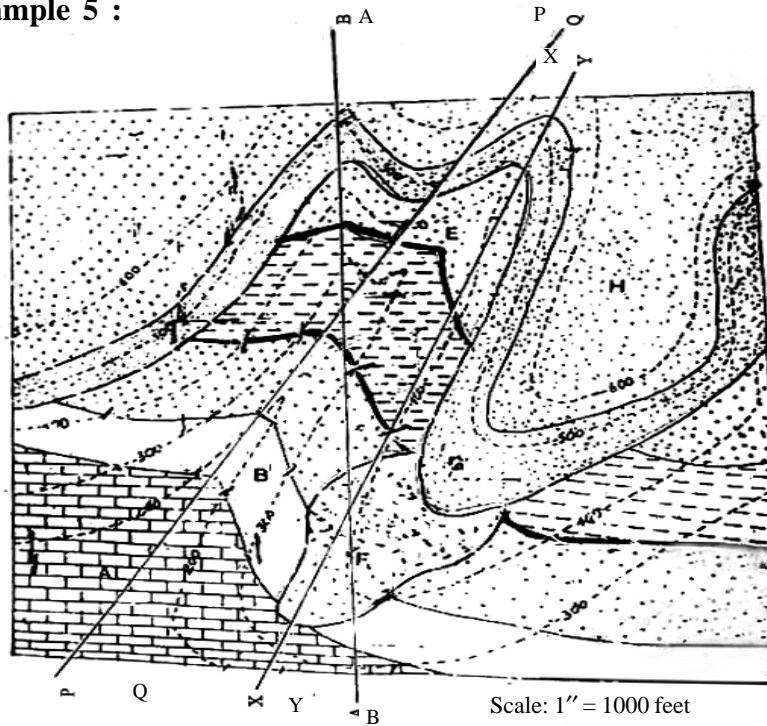

Figure: Geological section of the Map No.7 in the same scale.

A) Example 5 :



Horizontal Scale 1" = 1000 feet

Vertical Scale 1" = 1000 feet

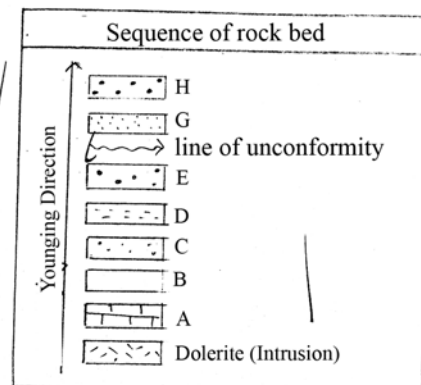

F) Example 6 :

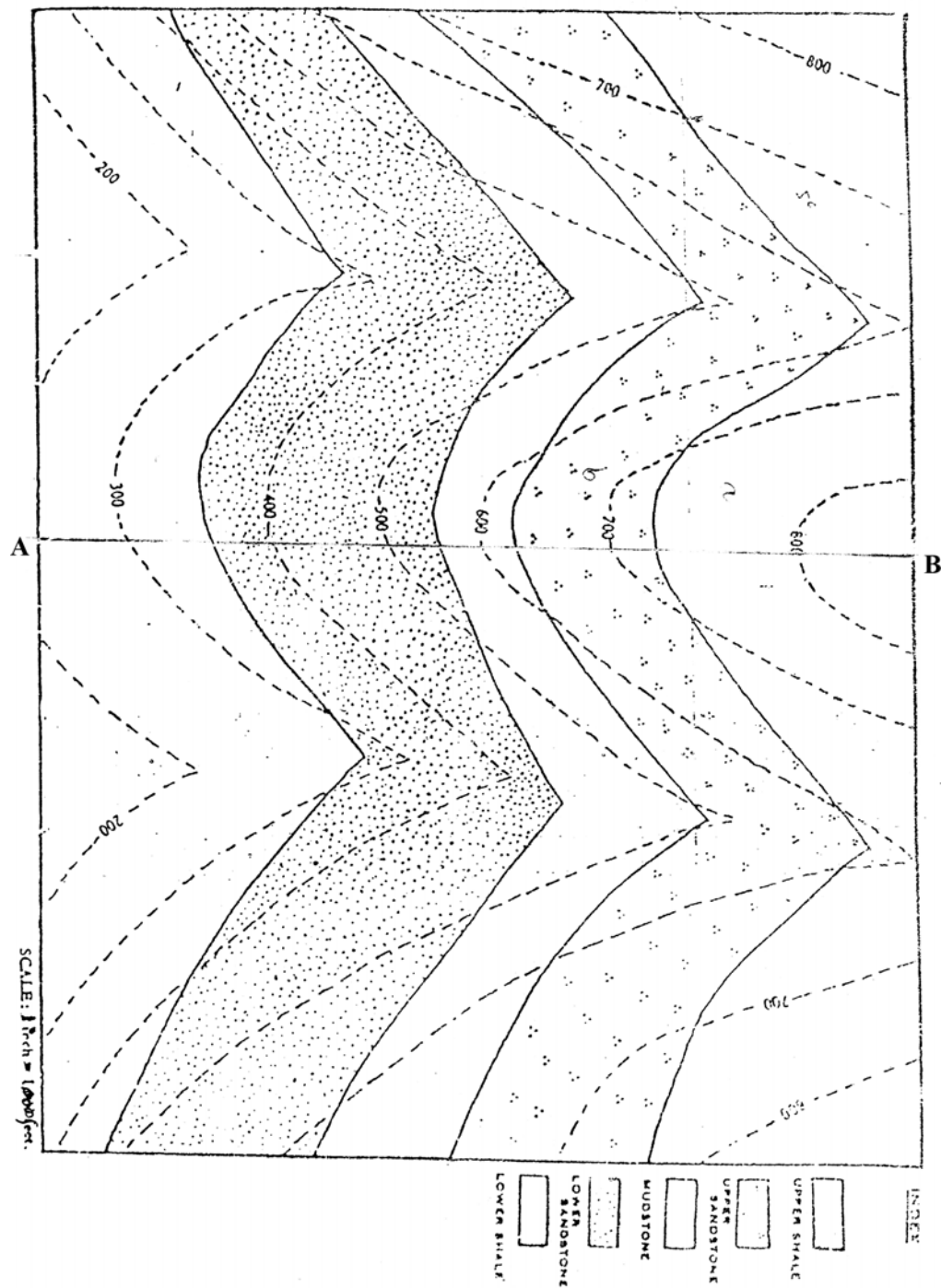

G) Example 7 :

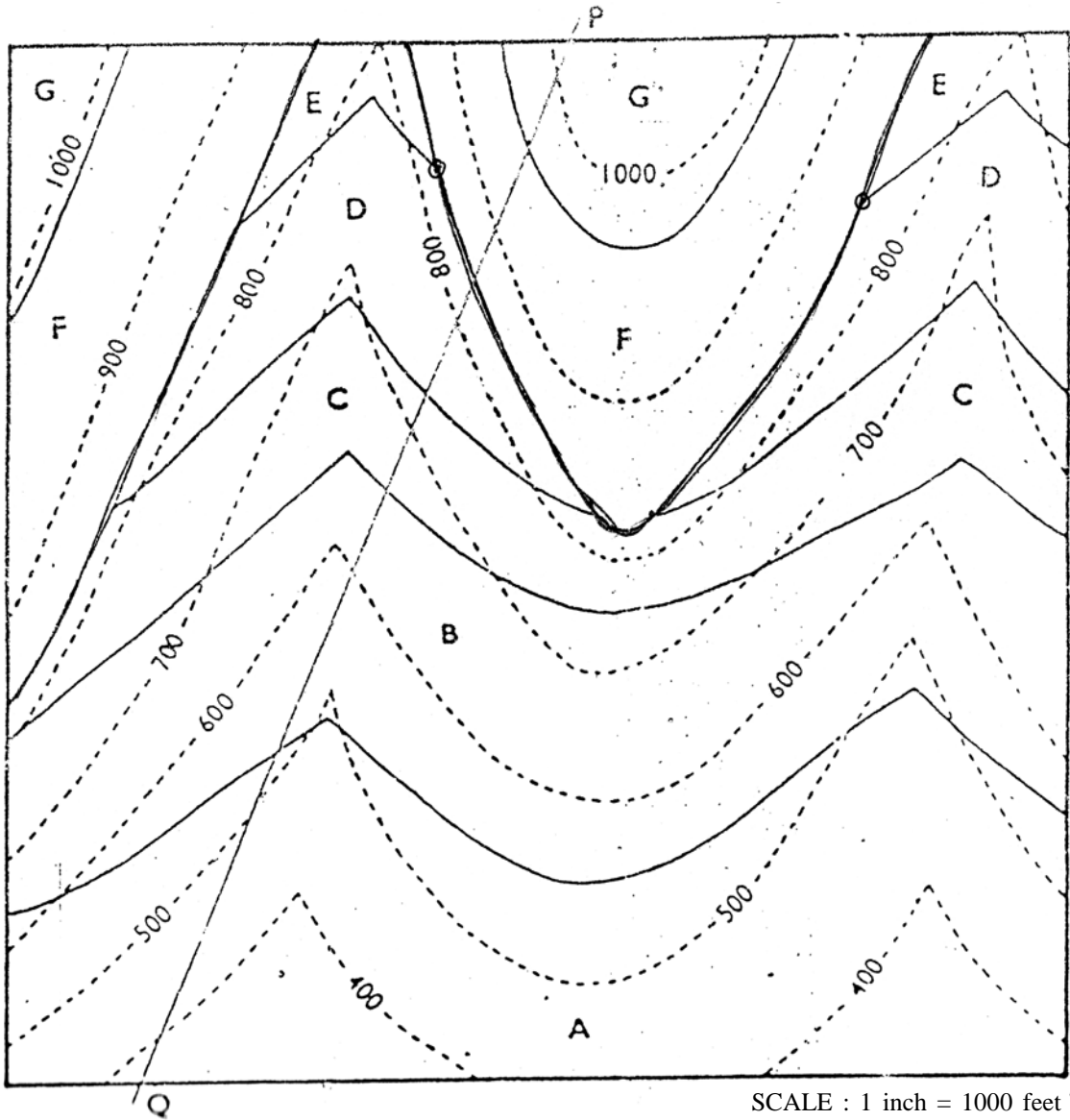

H) Example 8 :

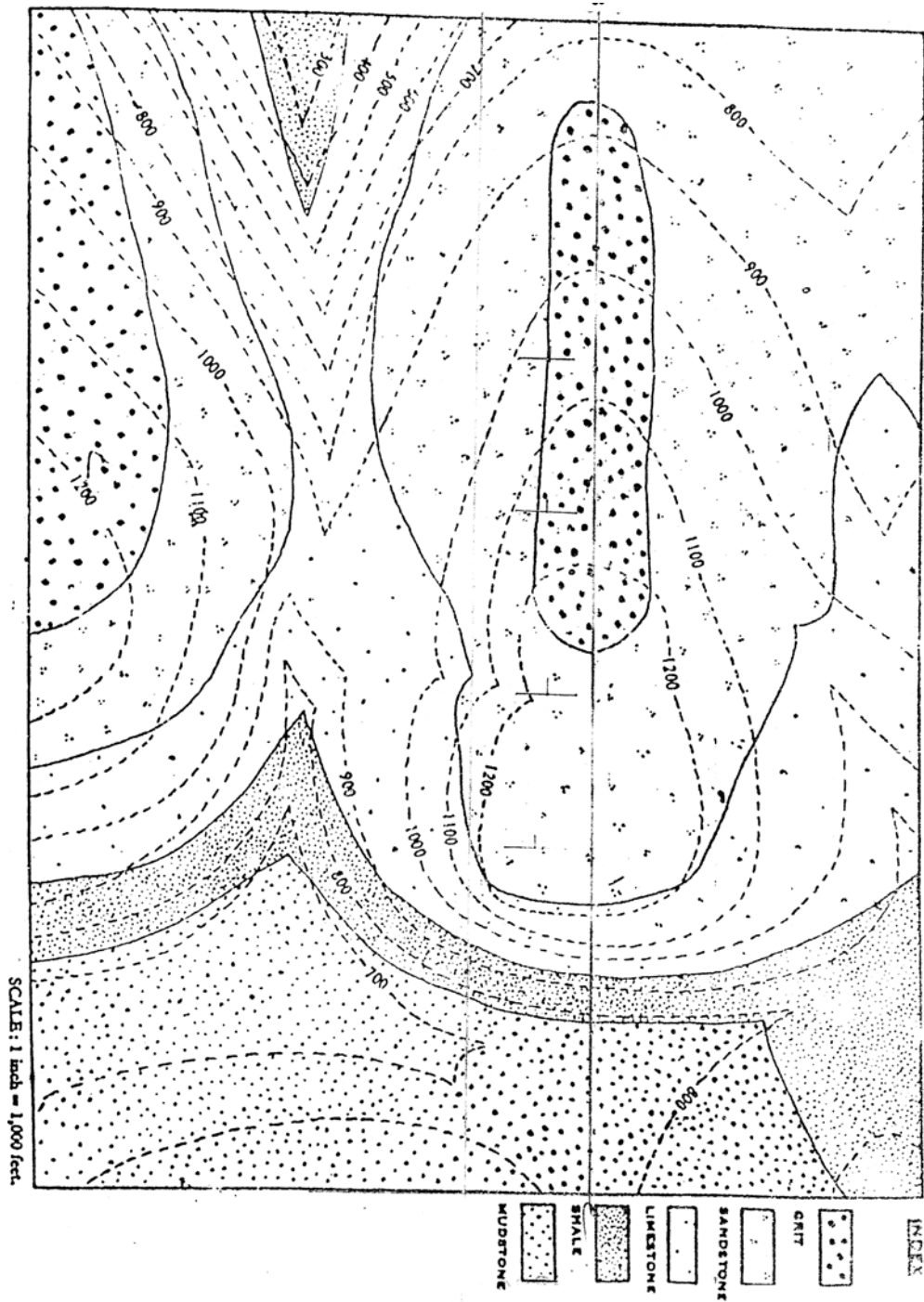

I) Example 9 :

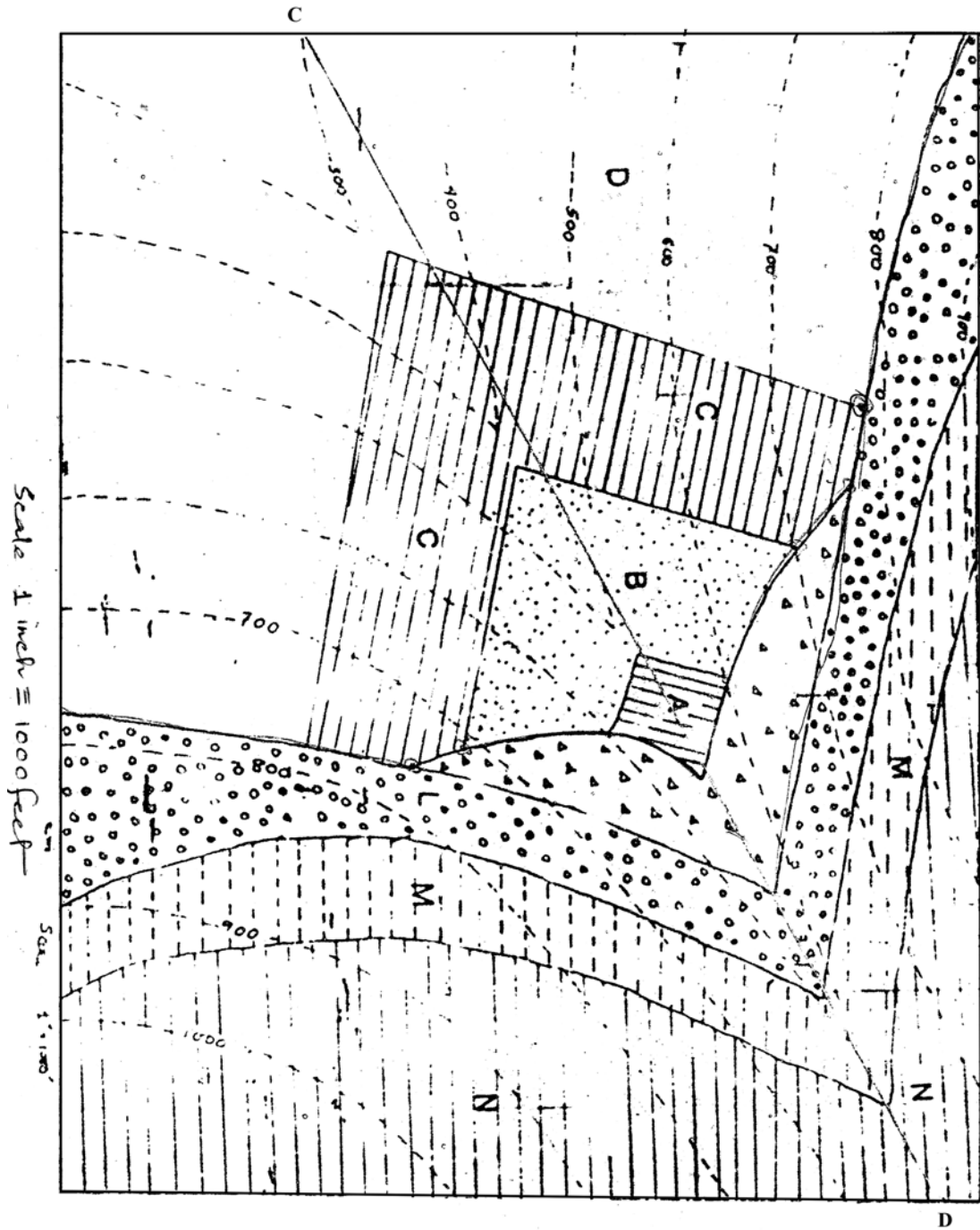

J) Example 10 :

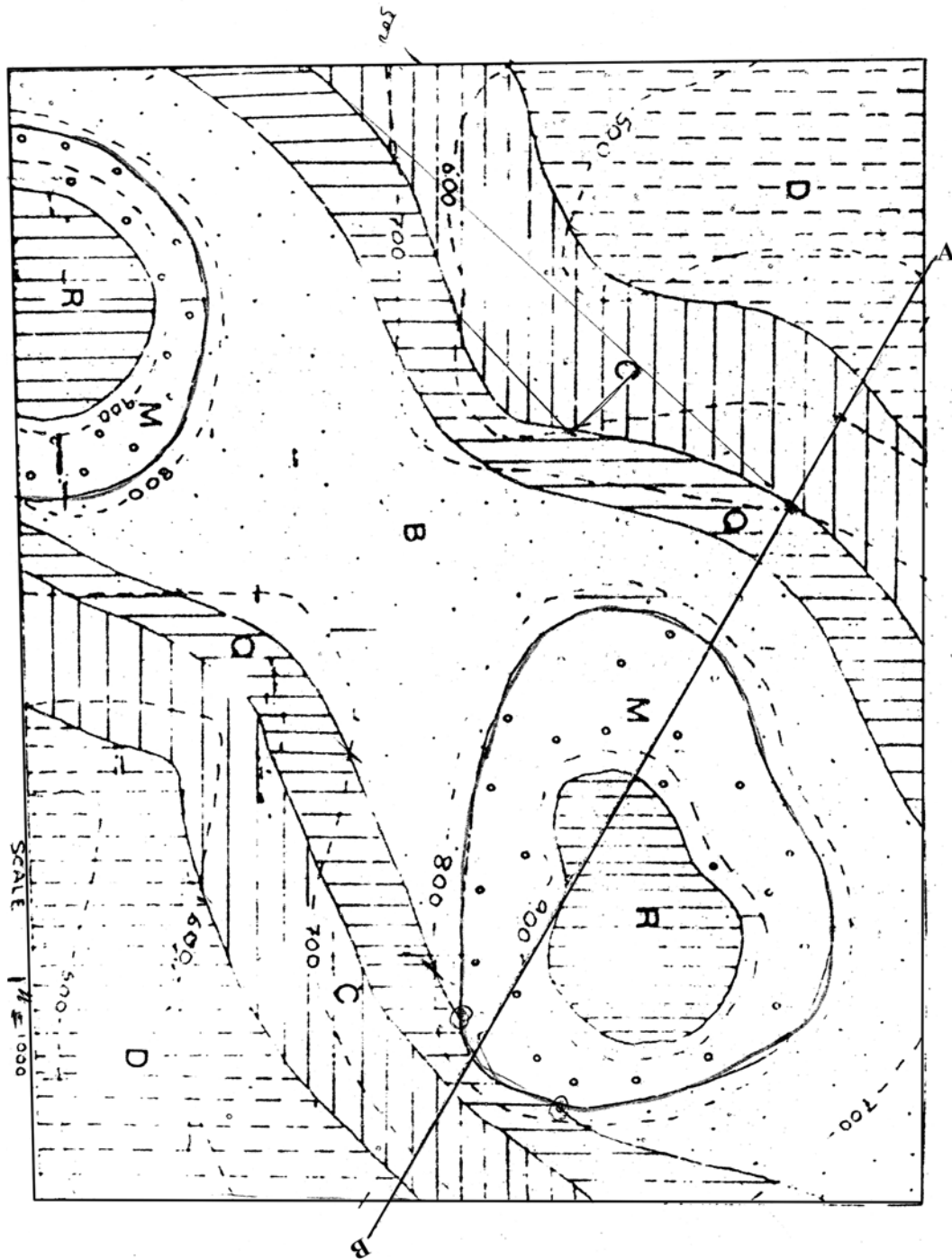

K) Example 11 :

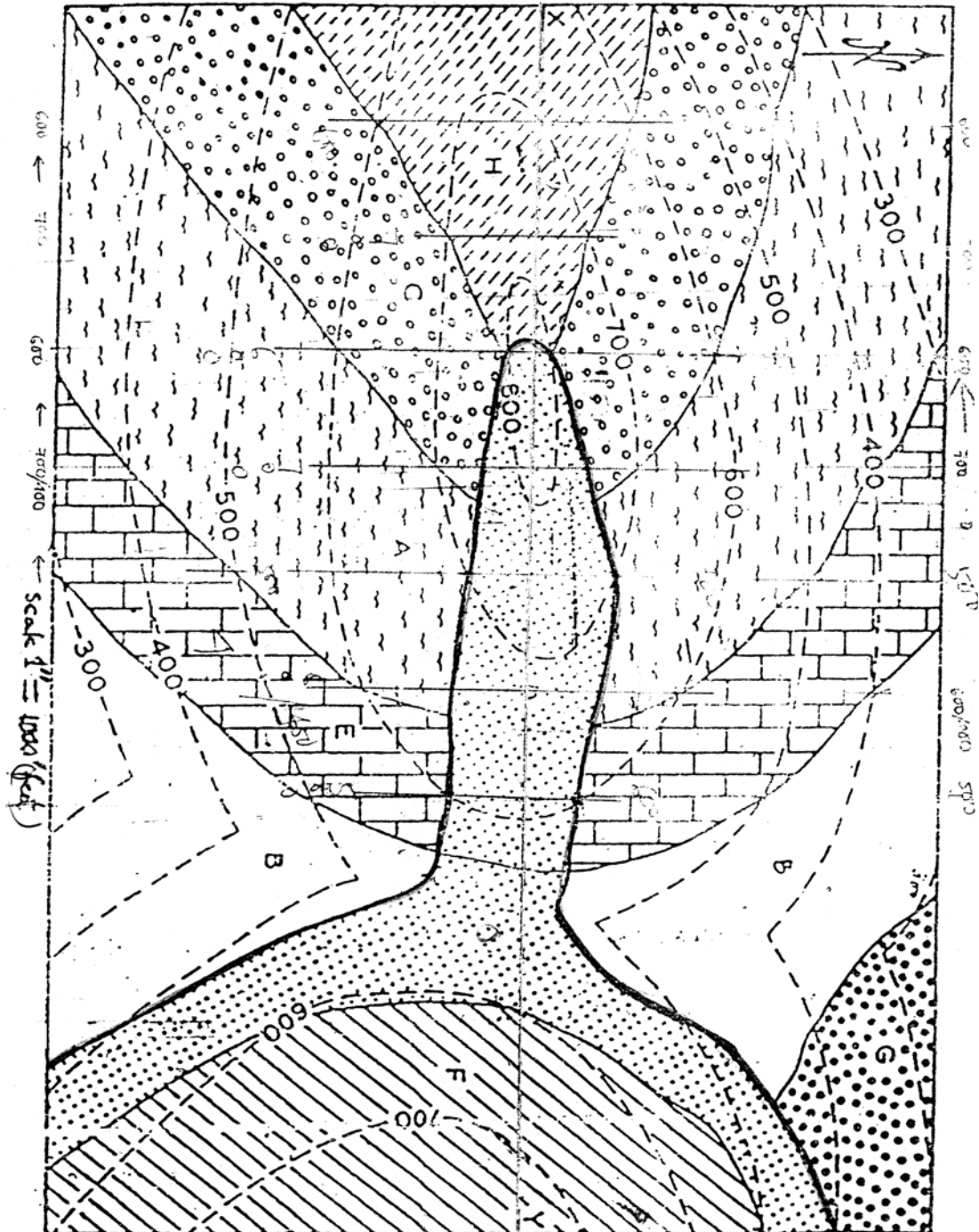

Summary/Learning Outcomes:

The learning outcomes of the blocks are :

- 1) The study of Indian topographical map helps to understand different physical and cultural elements.
- 2) The correlation between different physical and cultural elements of topographical map can easily understood by gaining the knowledge to topographical sheets.
- 3) By gaining knowledge one can delineate the drainage basin from the given topographical map.
- 4) Students can construct the hypsometric curve from the topographical map.
- 5) The identification of different rocks and minerals can be done by the learners by acquiring the knowledge about such rocks and minerals.
- 6) The knowledge of the study of geological maps enhanced the skills, helps to understand and interpretation of different types and structures of such maps.
- 7) The learners of geography discipline can describe and prepare particular assignment and solve problems related to the topics of the blocks after studied minutely.
- 8) The practical experience of solving geomorphological problems in this block will definately enhanced the skills of the learners in this discipline and strengthen the theoretical base of geomorphology and geotectonics.

Questions:

1. Draw a Broad Physiographic Division map of the given topographical map.
2. Draw Longitudinal Profiles, Serial Profiles, Superimposed Profile, Projected Profile Composite Profile and state their importance.
3. Draw a Relative Relief map and interpret it.
4. Draw a Average Slope map and interpret it.
5. Draw the Drainage Patterns of the map and interpret them.
6. Draw a Drainage Density map and interpret it.
7. Establish the correlations of Relative Relief, Stream Frequency and Drainage Density of a common area of the given topographical map

8. Draw a Vegetation Map and interpret it.
9. Draw a Settlement and Communication Map and interpret it.
10. Draw a Transect Chart to represent the correlation between physical and cultural features of the given topographical map.
11. Delineate a Drainage Basin the given topographical map and state its properties.
12. Draw a Drainage Density map by demarketing any Drainage Basin from the given topographical map and interpret it.
13. Draw a Stream Density map by demarketing any Drainage Basin from the given topographical map and interpret it.
14. Draw a Hypsometric Curve and state its significance.
15. Identify the given samples of minerals and state their three identifying features: Bauxite, Calcite, Chalcopyrite, Feldspar, Galena, Gypsum, Hematite, Magnetite, Mica, Quartz, Talc, Tourmaline.
16. Identify the given samples of rocks and state their three identifying features: Granite, Basalt, Dolerite, Laterite, Limestone, Shale, Sandstone, Conglomerate, Slate, Phyllite, Schist, Gneiss, Quartzite, Marble.
17. Measure the dip and strike by using clinometers.
18. Draw profiles along a cross section of the given Geological Map and interpret it. (Horizontal structure).
19. Draw profiles along a cross section of the given Geological Map with Uniclinal structure and interpret it.
20. Draw profiles along a cross section of the given Geological Map with Simple Anticlinal and Synclinal Fold Structure and interpret the map.
21. What are the major criteria to identify and interpret a geological map.
22. State about the succession, structure, topography, relation between structure and topography and geological history of geological maps.

References:

- Dury, G.H. (1971): Map Interpretation, Pitman Publishing.
- Hammond, R. and Macullagh, P.S. (1974): Quantitative Methods in Geography, Clarendon Press, Oxford.

- Mishra, R.P. (2009): Elements of Cartography. 6th Ed, Wiley
- Monkhouse, F.J. and Wilkinson, H.R. (1789): Maps and Diagrams: Their compilation and construction, P.I. Pub. Pvt. Ltd., New Delhi.
- Robinson, A. H., Sale, R.D., Morrison, J. (1980): Elements of cartography, Wiley, New York.
- Saha, P.K. and Basu, P. (2003): Practical Geography: A Laboratory Manual, Kolkata.
- Singh, R.J., (1991): Elements of Practical Geography, Kalyani Publishers.
- Bolton. T. (2009): (reprint). Geological Maps: Their Solution and Interpretation, Cambridge Univ. Press
- Farndon, J. (2012): The Illustrated Guide to Rocks & Minerals, Southwater.
- Kimerling, A.J., Buckley, A.R., Muehrcke, P.C., Muehrcke, J.O. (2011): Map Use: Reading, Analysis, Interpretation, 7th ed, Esri Press.
- McCullough, P.K. (1978): Modern Concept in Geomorphology, Oxford University Press.
- Pillent, C. (2002): Smithsonian Handbooks: Rocks & Minerals, Dorling Kindersley.
- Sarkar, A. (2015): Practical Geography: A Systematic Approach, 3rd ed, Orient Blackswan Private Ltd.
- Sen, P.K. (1989): Geomorphological Analysis of Drainage Basin: An Introduction to Morphometric and Hydrological Parameters, University of Burdwan.
- Sorrell, C.A. (2001): Rocks and Minerals: A Guide to Field Identification, St. Martin's Press.

Block-II

Climatology Laboratory

Learning Objectives:

- 1) To learn the uses of analogue instrument for the measurement of different weather elements.
- 2) To study the daily weather map of India and learn to interpret it.
- 3) To construct and interpret Climograph to identify the climatic conditions.
- 4) To study different climatic conditions and construct Wind Rose diagram
- 5) To construct Climatic Chart and learn to interpret it by understanding the related weather features.
- 6) To construct the Ombrothermic Chart and learn to interpret it using the weather conditions.

Unit 1 □ Measurement of Weather Elements using Analogue Instruments: Mean daily temperature, Air pressure

Structure

- 1.1 Concepts of Weather and Climate**
- 1.2 Measurement of Weather Elements**
 - 1.2.1 Temperature Measurement by Six's Maximum and Minimum Thermometer**
 - 1.2.2 Temperature Measurement by Rutherford's Maximum and Minimum Thermometer**
 - 1.2.3 Temperature Measurement by Sterenson's Screen**
 - 1.2.4 Air pressure Measurement**
- 1.3 Case Study : Weather Element Measurement by Analogue Instrument**
 - 1.3.1 Barometer**
 - 1.3.1.1 Introduction**
 - 1.3.1.2 Measurement of Reading**
 - 1.3.1.3 Example**
 - 1.3.2 Six's Maximum and Minimum Thermometer**
 - 1.3.2.1 Introduction**
 - 1.3.2.2 Measurement of Reading**

1.1 Concept of Weather and Climate

Concept of Weather: Temperature, sunshine, wind direction, wind velocity, precipitation, etc., are hardly stable at a place. They change rather quickly as time passes and their values may vary from place to place at a particular time. *Weather* is the state of the atmosphere at a place at a particular time, or for a short spell of time, with reference to temperature, atmospheric pressure, wind direction, wind velocity, sunshine, cloudiness, precipitation, etc. The spell of time may be as short as an hour or so or as long as a day. Elements such as temperature, atmospheric

pressure, wind direction, clouds, precipitation, etc., which form weather of a place, are called *weather elements*.

Concept of Climate: The average condition of the weather elements of a place over a long period of time is far less variable than the ever changing state of weather elements. The knowledge of changes taking place quickly in the weather condition is useful but that of the average weather condition over a long period of time say a few years, being nearly the same every year, is easily definable and reckonable and thus more useful. *Climate* is defined as the average weather condition of a place over a long period of time which should be at least 30 years.

1.2 Measurement of weather elements

The measurement of weather elements is basic to the study of the weather and climate of a place. We shall study the following weather elements:

1. Temperature, 2. Atmospheric pressure, 3. Wind direction, 4. Wind velocity, 5. Humidity and Rainfall, 6. Cloud amount.

1.2.1 Temperature Measurement by Six's Maximum and Minimum Thermometer:

Temperature is the degree of hotness and coldness of an object as measured with a thermometer. Heat being basic to life on earth, knowledge of temperature of different places is obviously useful. In India the Centigrade scale, internationally known as Celsius scale since 1948 after the name of its inventor A. Celsius (1701-44), is used for measuring temperature. According to this scale, water boils at 100° and freezes at 0° at sea-level and these figures are written as 100°C and 0°C. The thermometer calibrated according to Centigrade scale is called Centigrade thermometer (having a hundred degrees). Before the introduction of metric system of measurements, the Fahrenheit scale was used for measuring temperature. In some countries, this scale is still being used. According to this scale water boils at 212° and freezes at 32° and these figures are written as 212°F and 32°F. The thermometer calibrated according to the Fahrenheit scale is called Fahrenheit thermometer after name of its inventor G.D. Fahrenheit (1686-1736).

The formula for converting a Celsius temperature to a Fahrenheit temperature is

$$C = \frac{5}{9}(F - 32)$$

The formula for converting a Fahrenheit temperature to a Celsius temperature is

$$F = \frac{9}{5}C + 32$$

The temperature of a place is in fact the temperature of air near the ground under shade. It is minimum at about 4 A.M. and maximum at about 2 P.M.

Six's Maximum and Minimum Thermometer:

Introduction: This thermometer is used to measure the minimum and maximum temperatures of a day.

Description: It consists of a U-shaped tube having a narrow uniform bore. Both the ends of the tube are drawn into bulbs. The bulb (A) on the left side is completely full of alcohol; the bulb (D) on the right side is conical and is partially filled with alcohol. The U-shaped portion of the tube contains mercury (Fig.2.1). Above the mercury columns there are two steel indices E and F. These indices do not move up or down by themselves and remain in position unless pushed upwards by the rising mercury. Steel springs are attached to the steel indices. They are strong enough to press the indices against the wall of the bore of the tube and thus keep the indices in position.

The movement of mercury is controlled by the alcohol in the bulb A. Alcohol expands about 6 times as much as a mercury. When temperature rises, alcohol in the bulb A expands. Being a very thin liquid it passes through the space between the steel

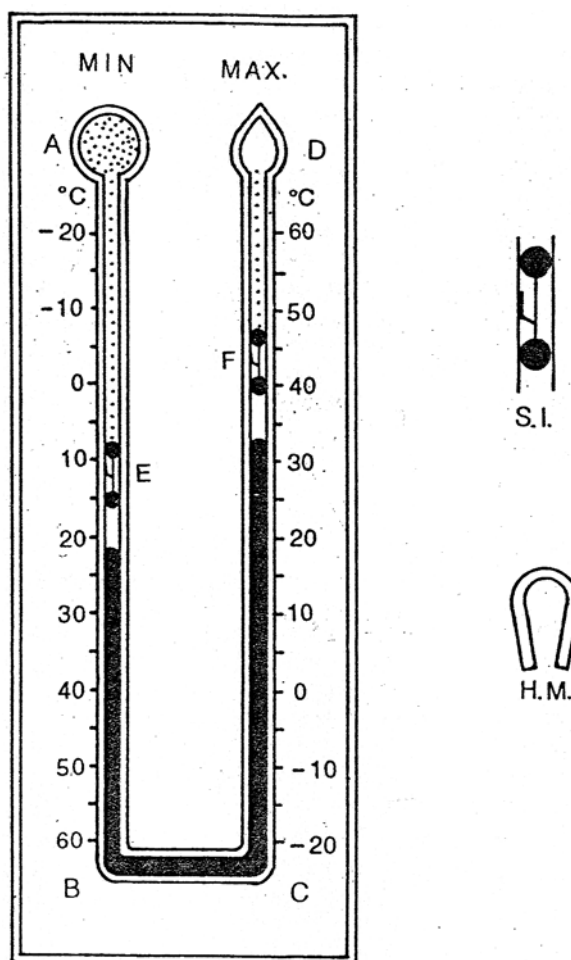

S.I.=Steel index

H.M.=Horse-shoe magnet

Fig. 2.1

index (E) and the wall of the bore of the tube and pushes the mercury column in the tube AB downwards. Obviously, the mercury column in the tube CD will rise. The rising column of mercury will push the steel index F upwards. It will continue pushing the steel index F upwards until temperature stops rising. The lower end of the steel index F will indicate the maximum temperature. When temperature begins to fall, the alcohol in the bulb A contracts. The contracting alcohol drags mercury behind it. Thus on the contraction of alcohol in the bulb A, the mercury column in the tube AB rises. The rising column of mercury pushes the steel index E upwards until temperature stops falling. The lower end of the steel index E indicates minimum temperature. Thus, the figures indicating temperature on the tube CD increase in value upwards and the figures indicating temperature on the tube AB decrease in value upwards. Alcohol in the bulb D does not play any part in the movement of mercury; its main function is to exert a little pressure on the mercury column and this stop it from breaking.

Every Six's Maximum and Minimum Thermometer is accompanied with a small horse-shoe magnet. This magnet is used to bring the steel indices in contact with mercury. The magnet is placed on a steel index and dragged towards mercury until the index touches mercury. The steel indices are brought in contact with mercury. The steel indices are brought in contact with mercury columns every day at 5-30 P.M. Next day we note down the minimum temperature at 8-30 A.M. and the maximum temperature at 5-30 P.M. Thus, we get minimum temperature and maximum temperature of a day and of all days of a month.

It may, however, be noted that in the meteorological observatories, two separate thermometers (i) Rutherford's Maximum Thermometer and (ii) Rutherford's Minimum Thermometer are used for recording maximum and minimum temperatures instead of a Six's Maximum and Minimum Thermometer.

1.2.2 Temperature Measurement by Rutherford's Maximum and Minimum Thermometer:

(i) Rutherford's Maximum Thermometer: It is a mercury thermometer and it has a steel index (Fig.2.2). It is mounted on a wooden board and is hung horizontally in Stevenson's Screen. A horse-shoe magnet is used to bring the steel index in contact with mercury. When temperature rises, mercury expands and the expanding mercury

pushes the index forward; and when the temperature falls, mercury contracts and recedes without disturbing the index. The end of the index facing the mercury thread, indicates the maximum temperature.

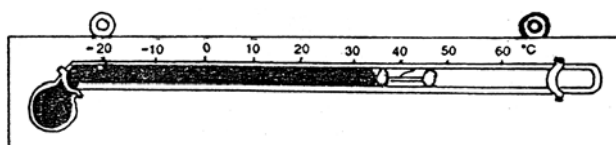

Fig. 2.2

(ii) **Rutherford's Minimum Thermometer:** This thermometer has alcohol instead of mercury (Fig.2.3). It has a glass index instead of a steel index. The thermometer is mounted on a wooden board and is hung horizontally in Stevenson's Screen. The glass index is always immersed in alcohol. The thermometer is tilted slightly to allow the glass index to take a position in which its outer end of the index facing the empty end of the thermometer) touches the concave surface of alcohol. When the temperature falls, alcohol contracts and recedes. The concave surface of the receding alcohol drags the glass index towards the bulb of the thermometer. The outer end of the glass index indicates the minimum temperature. When temperature increases, alcohol expands and it being a very thin liquid flows through the space between the bore of the thermometer and the glass index without disturbing the latter.

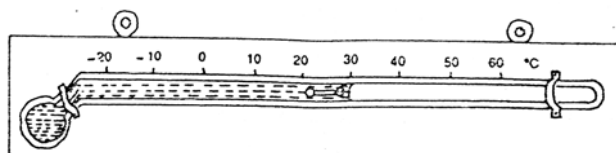

Fig. 2.3

1.2.3 Temperature Measurement by Stevenson's Screen:

For measuring temperature of air thermometers are kept under from buildings. A specially designed wooden box supported by four wooden legs is thermometers. This box is called Stevenson's Screen. The length, breadth and height of the structure of the box are 57.2 cm, 31.4 cm. and 41.6 cm. respectively. The box is painted white, it has louvered sides for excluding sun and rain but for admitting air, and double top and double bottom. The bottom of the box is 1.066 metres above the the ground.

The upper layer of the roof projects for 5.1 cm. beyond the sides of the box and is sloping. Stevenson's Screen is fixed in the open area away from buildings and trees. It is fixed in such a way that its door faces north. Rutherford's Maximum Thermometer, Rutherford's Minimum Thermometer, horse-shoe magnet, and wet and dry-bulb thermometers are placed inside Stevenson's Screen.

Fig. 2.3

(i) **True daily mean temperature:** In some observatories, temperature is recorded every hour. The sum of hourly temperatures recorded during the 24-hour day divided by 24 gives the true daily mean temperature.

True Daily mean temperature =

$$\frac{\text{Sum of hourly temperatures recorded during the 24-hour day}}{24}$$

(ii) **Daily mean temperature:** There are very few observatories where temperature is recorded every hour. In most of the observatories only the maximum temperature and the minimum temperature are recorded during the 24-hour day. The daily mean temperature is obtained by dividing the sum of the maximum temperature and the minimum temperature recorded during the 24-hour day by 2.

Daily mean temperature =

$$\frac{\text{Maximum temperature} + \text{Minimum temperature during the 24-hour day}}{2}$$

It is from the daily mean temperature that we calculate other temperature values namely the mean monthly temperature, the annual range of temperature. Thus, daily mean temperature is a basic temperature value.

(iii) **Daily range of temperature:** It is obtained by subtracting the minimum temperature from the maximum temperature of the 24-hour day.

(iv) **Mean monthly temperature:** We get the mean monthly temperature of a month by adding the daily mean temperature for all the days of the month and dividing this sum by the number of the days of the month.

(v) **Daily normal temperature:** It is the mean daily temperature of the same day of the past at least 30 years.

Example I. Temperatures recorded hourly at a station during the 24-hour day are given below.

Hours	Temperature (0°C)	Hours	Temperature (0°C)
0100	7.5	1300	22.5
0200	6.8	1400	23.8
0300	5.9	1500	23.2
0400	5.4	1600	22.0
0500	6.3	1700	20.1
0600	7.8	1800	18.6
0700	9.2	1900	16.8
0800	11.2	2000	15.2
0900	14.8	2100	13.5
1000	16.5	2200	11.2
1100	18.6	2300	10.4
1200	21.2	2400	8.9

Find out (i) the true daily mean temperature, (ii) the mean daily temperature and (iii) the daily range of temperature.

Solution:

(i) True daily mean temperature

$$= \frac{\text{Sum of hourly temperatures recorded during the 24-hour day}}{24}$$

$$= \frac{337.4}{24}$$

$$= 14.06^{\circ}\text{C}.$$

$$\text{(ii) Daily mean temperature} = \frac{5.4+23.8}{2} = \frac{29.2}{2}$$

$$= 14.6^{\circ}\text{C}.$$

(iii) Daily range of temperature = $23.8 - 5.4$
= 18.4°C .

Example 2. On 1.8.1975, the maximum temperature was 35°C and minimum temperature 26°C . Find out (i) the daily mean temperature and (ii) the daily range of temperature on 1.8.1975.

Solution:

(i) Daily mean temperature on 1.8.1975 = $\frac{35+26}{2} = 30.5^{\circ}\text{C}$.

(ii) Daily range of temperature on 1.8.1975 = $35^{\circ}\text{C} - 26^{\circ}\text{C} = 9^{\circ}\text{C}$.

1.2.4 Air Pressure Measurement

Introduction: Atmospheric pressure is not constant at a place. It also varies from place to place. The study of the variations in the atmospheric pressure from place to place and from time to time is very essential for forecasting a storm, rain, dry conditions, fair weather, etc. The knowledge of these weather conditions in advance is useful for sailors, airmen, fanners, etc.

Barometer: Air has weight. Therefore, the atmosphere exerts pressure. This pressure is measured with an instrument called a barometer. There are four types of barometers. They are:

- (i) Aneroid Barometer
- (ii) Barograph
- (iii) Fortins Barometer
- (iv) Kew Pattern Barometer.

(i) Aneroid Barometer: This barometer is commonly used by seamen, airmen and mountaineers for knowing the atmospheric pressure and related weather, and height above sea-level.

This barometer has no liquid in it. It consists of a small metallic box appearing like a disc. A partial vacuum is created inside the box and it is closed air-tight with a thin corrugated flexible metallic lid (Fig.2.4). The lid is depressed when the atmospheric pressure increases and is raised upward when the atmospheric pressure decreases. This up and down movement of the lid is very small and is, therefore, magnified with the help of levers.

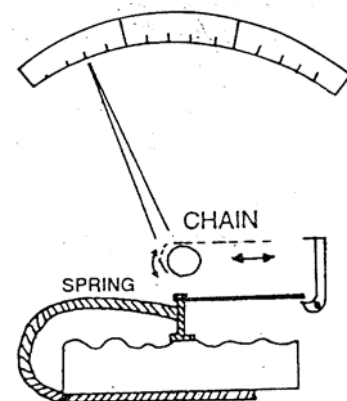

Fig. 2.4

The levers are connected to a needle which moves over a graduated dial marked with figures indicating the pressure in kilometres, inches and millibars. In addition to these figures a few words namely 'Stormy', 'Rain', 'Fair', and 'Dry' are written on the dial.

There is another needle, generally of red colour. It can be rotated with the help of a metallic stud fixed at the glass cover of the barometer. This is an index needle and is brought above the needle which actually moves due to changes in pressure. After some time the needle below moves away indicating how much variation there has been in the pressure after the index needle was brought above this needle.

This is a small-sized, portable and metallic barometer it is also quite sensitive to the changes in pressure. A sensitive instrument will indicate a change in pressure when it is raised up even for a metre. It can be fixed in any position in contrast to a mercurial barometer which has to be fixed in a vertical position for correct readings. Owing to these merits of an aneroid barometer, it is very commonly used by seamen, airmen and mountaineers.

Uses of aneroid barometer. There are two types of aneroid barometer. One is used for forecasting weather and the other is used to measure height above sea-level. The barometer used to measure altitude is known as an altimeter.

If the needle of an aneroid barometer does not fluctuate and remains nearly steady, it indicates that there will be no appreciable change in the weather conditions for some time. If the pressure starts increasing, it indicates that anticyclonic conditions are establishing themselves and dry conditions will prevail for some time. The falling pressure, however, indicates that cyclonic conditions have started developing and rain may fall. If the pressure falls rapidly, there is a possibility of a storm.

An *altimeter* is a special type of aneroid barometer used to measure height above sea-level. The graduations on its dial show height in metres or feet. Altimeters are carried by mountaineers, surveyors and are fitted in aeroplanes for knowing the height above sea-level.

The atmospheric pressure decreases with height. It falls roughly at the rate of 34 millibars for an ascent of 270 metres or one inch for an ascent of 900 feet. It should, however, be noted that the atmospheric pressure at a place changes from time to time and above a height of 1000 metres, the rate of fall in pressure progressively declines. Therefore, the readings recorded by an altimeter at a place change accordingly. Temperature and latitude of a place also affect its atmospheric pressure. To get accurate height, temperature, altitude and latitude corrections are applied to the

readings of the altimeter. But this involves mathematical calculations. Therefore, tables are provided with each altimeter for finding out the height of a place above sea-level.

(ii) **Barograph.** It is a combination of an aneroid barometer and a rotating drum. A set of levers is so arranged as to convey the movement of the flexible lid of the box of the barometer, to a needle which rests on the drum. This has an ink or a pencil point. A graph paper is wrapped round the drum and the drum is allowed to complete one rotation in a day (24 hours) or a week. A curve indicating the changes in the pressure is marked on the graph paper. The graph paper is changed in some barographs daily and in the others every week.

(iii) **Fortin's Barometer.** It is a mercurial barometer and is fitted in the laboratories and meteorological observatories for recording atmospheric pressure. It indicates atmospheric pressure accurately.

It consists of a 100 cm. long glass tube (Fig.2.5). The tube is mounted on a board and stands in a vertical position. Its upper end is closed and its lower end is bent upwards. The tube contains mercury and its lower end dips in mercury kept in a reservoir made of glass. A leather piece in the form of a bag is attached to the lower end of the reservoir. The leather can be raised or lowered with the help of a screw fixed at the bottom of the leather bag. With the rise or fall of the leather piece, the level of mercury in the reservoir can be raised or lowered. An ivory pointer pointing downward to the mercury reservoir is fixed in the lid of the reservoir. The ivory pointer indicates zero reading. A vernier scale is used to read the pressure accurately. The scale is made to move up or down with the help of a knob. To read the pressure, proceed as follows:

(a) Make the ivory pointer just touch the surface of mercury by using the screw *S* (Fig. 2.5).

(b) Slide the vernier scale up or down till its lower edge appears to touch the convex surface of mercury.

(c) If the zero of the vernier scale is, say, between 745 and 746 mm. and the vernier constant is 0.1 mm. and if the 5th division on the the vernier scale coincides with a scale division, the atmospheric pressure

$$= 745 + 5 \times 0.1$$

$$= 745.5 \text{ mm.}$$

(iv) **Kew Pattern Barometer.** Fortin's Barometer is no longer used in the meteorological observatories. Now Kew Pattern Barometer is used. Its construction is almost similar to that of Fortin's Barometer except that the reservoir of mercury is made of steel and there is no screw under it. Thus, there is no need to bring the ivory pointer in contact with mercury. This barometer is easy to operate and it gives the pressure reading quickly. There is also an arrangement by which it always remains vertical.

Unit of measurement of atmospheric pressure. Atmosphere has weight. Therefore, the atmospheric pressure is measured in the units of force. The unit of force used for measuring atmospheric pressure is the millibar. The average value of the atmospheric pressure on the surface of the earth at sea-level is equivalent to 760 mm. or 29.925 inches at latitude 45°N, and temperature 0°C. The force exerted by 760 mm. high mercury column is equal to 1,013,231 dynes per square centimetre.

Now a bar is equal to 1,000,000 dynes and a millibar is equal to 1,000 dynes i.e. one thousandth part of a bar.

$$1 \text{ bar} = 1,000,000 \text{ dynes}$$

$$1 \text{ millibar (mb)} = 1000 \text{ dynes}$$

$$\text{But } 1000 \text{ mb} = 750.1 \text{ mm. or } 29.53 \text{ inches}$$

$$\therefore 1 \text{ mb.} = 0.7501 \text{ mm. or } 0.02953 \text{ inch}$$

$$\text{and } 34 \text{ mb} = 1 \text{ inch.}$$

The average atmospheric pressure at sea-level is 1013.23 mb. The atmospheric pressure at sea-level varies generally between 940 mb. and 1050 mb.

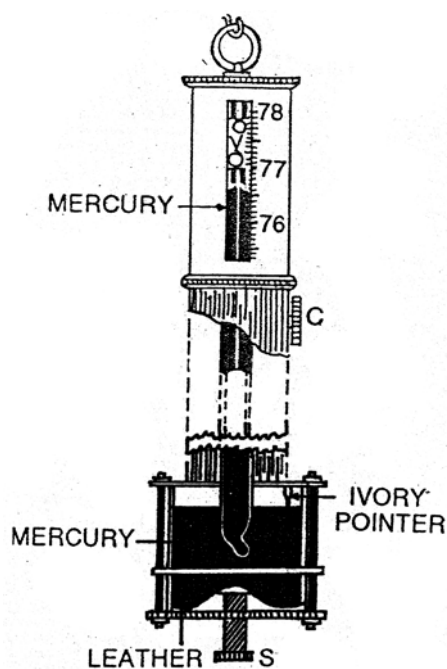

Fig. 2.5

1.3 Case Study: Weather Element Measurement by Analogue Instrument

1.3.1 Barometer:

1.3.1.1 Introduction: In, 1643 Torrecelli first introduce Barometer. Later, Fortin, Kew and Aneroid Barometers were being prepared based on the method of Torrecelli.

1.3.1.2 Measurement of Reading: It is important to know the reading of vernier scale to determine the vernier constant. The value of vernier constant may differ according to instruments. The vernier constant is to be determined by the formula—

$$\text{Vernier constant (v.c.)} = \frac{d}{n} \left[\begin{array}{l} \text{Where,} \\ d = \text{smallest main scale division} \\ n = \text{Number of vernier division} \end{array} \right]$$

1.3.1.3 Example:

(a) Smallest main scale division (d) = 0.1 cm.

(b) Number of vernier division (n) = 10 (which is equal to 9 main scale division)

$$\begin{aligned} \text{Then, v.c.} &= \frac{d}{n} \\ &= \frac{0.1}{10} \text{ cm.} = 0.01 \text{ cm.} \end{aligned}$$

It is helpful for the final reading from Barometer.

$$\begin{aligned} \text{Barometer reading} &= (\text{Main scale} + \text{Vernier scale}) \text{ reading} \\ &= [0.01 \times 15 = 0.15 \text{ cm}] \\ &= (76.40 + 0.15) \text{ cm} \\ &= 76.55 \text{ cm} \\ &= 765.3 \text{ (mm)} \end{aligned}$$

N.B. : For the correct reading. We need to take the Barometer thrice and the make the average value.

Determination of wind pressure by Fortin's Barometer

Place:

Date:

Instrument No.:

Time:

No. of reading	Main Scale reading	Vernier constant	No. of vernier scale division	Vernier scale reading	Final reading (cm)	Mean pressure (mm)	Temperature (cf)
1st	76.4	0.01	11	0.01×11 = 0.11	76.4+0.11 = 76.51		84
2nd	76.4	0.01	12	0.01×12 = 0.12	76.4+0.12 = 76.52	765.2	84
3rd	76.4	0.01	13	0.01×13 = 0.13	76.4+0.13 = 76.53		84

1000 dynes = 1 milibar (mb)

1000 mb = 1 bar

1 bar = 29.92 Inch or 76 cm or 760 mm.

[mb = milibar
mm = millimeter
cm = centimeter]

$$\therefore \left[\frac{1000\text{mb} \times 765.2}{760} = \frac{765200}{760} \right] = 1006.84\text{mb}$$

Therefore, the above reading (765.20 mm) represents the air pressure of 1006.84 mb.

1.3.2 Six's Maximum and Minimum Thermometer:

1.3.2.1 Introduction: Six introduced the thermometer for the daily maximum and minimum temperature determination. It is helpful to determine daily, monthly and annual average temperature and range of temperature.

1.3.2.2 Measurement of Reading: Determination of Maximum and Minimum Temperature by Maximum and Minimum thermometer is as follows:

Place:

Date:

Instrument No.:

Date	Time	Temperature (°C)		Range of Temperature (°C)
		Maximum	Minimum	
15.04.2018	2.30 pm	32.5	24.3	8.2

Fortin Barometer

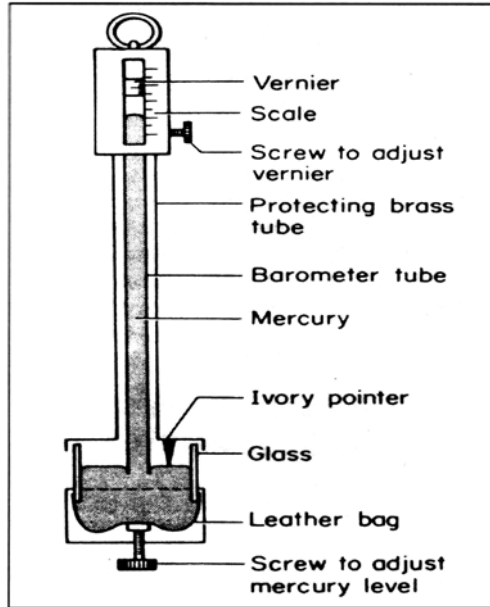

Fig. 2.6 Fortin Barometer

Six's Thermometer

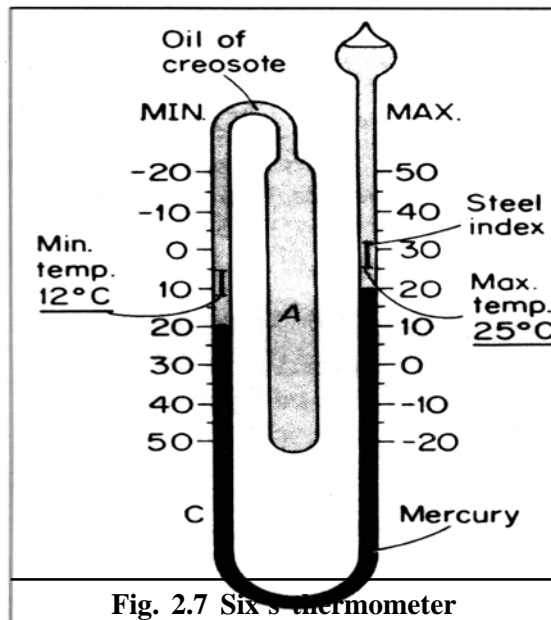

Fig. 2.7 Six's thermometer

Unit 2 □ Interpretation of a Daily Weather Map of India: Pre-Monsoon, Monsoon & Post-Monsoon

Structure

- 2.1 Concepts**
- 2.2 Purpose**
- 2.3 Types**
- 2.4 Analytical matter of Weather Map**
- 2.5 Identification of Season from Weather Map**
 - 2.5.1 Winter Season**
 - 2.5.2 Summer Season / Pre-Monsoon Season**
 - 2.5.3 Rainy Season / Monsoon Season**
 - 2.5.4 Post-Monsoon Season**
- 2.6 Weather Symbols**
- 2.7 Reading a Weather Map**
- 2.8 Some notes on the Weather Maps of India**
- 2.9 Metric Units for Weather Reports**
- 2.10 Weather Map Interpretation**
 - 2.10.1 Introduction**
 - 2.10.2 Pressure**
 - 2.10.3 Wind Condition**
 - 2.10.4 Sky Condition**
 - 2.10.5 Rainfall / Precipitation**
 - 2.10.6 Pressure-Wind-Cloudiness-Rainfall Relation**
 - 2.10.7 Other Atmospheric Phenomena**
 - 2.10.8 Sea Condition**
 - 2.10.9 Weather Forecasting**
- 2.11 Indian Daily Weather Report**
- 2.12 Weather Elements in a Weather Map/Report.**

2.13 Exercise of Weather Maps

2.1 Concepts

A weather map or chart shows on a flat sheet of paper on which all the data available consulting the weather for the given area at a particular moment of time is plotted. A weather map is the representation of the weather of a portion of the earth or a part of it on a flat surface. The term weather denotes, the condition of the weather elements at a particular place and time. Generally six weather elements are recognised. These are—

(i) Temperature (ii) Pressure (iii) Wind (iv) Humidity (v) Cloud (vi) Precipitation

Thus, we can define a weather map as a map of the world or part of it showing at a stated time numerically and with the help of symbols. The temperature and pressure conditions and direction and velocity of wind, humidity, clouds, visibility, nature and amount of precipitation weather chart enables to observe the development of weather patterns and to anticipate future developments. Conditions of weather elements are observed at different meteorological stations and same telegraphically to the head office for the final preparation of the weather report.

It is obvious that the recently of having a weather map was felt most by sailors. In 1699, **Edmund Hallay** published a map for 30°N and 30°S latitudes which showed trade wind and the direction of the prevailing monsoon. These map can not be taken to be a typical weather map because it denotes the weather condition over a period of time.

For preparation of a weather map showing the weather elements at different places for a particular point of time, a quick system of sending information was necessary. Thus with the advent of electric telegraph it became popular to prepare such weather maps. With further improvements in the system of news transmission by the wireless telegraph weather information from a large area could be gathered at a central stations.

The first publication of weather map of India was started at **Simla** in 1864. After first world war, the office of the Indian Meteorological Department was shifted to Pune. At present there are 350 Meteorological Observation Stations in India which have been classified into various categories based on the size, facilities and nature of information.

2.2 Purpose

To study this portion anybody can understand—

- 1) Definition of weather map
- 2) Importance of weather map
- 3) Different elements of weather map
- 4) Concepts of weather map
- 5) Regional variation of weather map
- 6) Predict the weather of a place.

2.3 Types

Meteorologists prepare different types of weather map taken—

- 1) Station Model based weather map
- 2) Non-station model based weather map
- 3) Upper air circulation weather map
- 4) Satellite photo based weather map

The Indian Weather Map provides 3 charts in one sheet. There is one large map at the top accompanied by two small maps at the bottom which provide information regarding departure of minimum temperature from normal and the departure of 8.30 hrs. pressure from normal.

2.4 Analyse Matter of Weather Map

Weather map discuss the following weather elements—

- (1) Atmospheric Pressure—
 - (a) Location of High Pressure (HP)
 - (b) Location of Low Pressure (LP)
 - (c) Trends of Isobars
 - (d) Pressure Gradient
- (2) Wind Condition—
 - (a) Wind Direction
 - (b) Wind Velocity
- (3) Sky Condition—
 - (a) Cloud Cover
 - (b) Other Weather Elements
- (4) Precipitation—
 - (a) Distribution of Rainfall
 - (b) Location of Rainfall

- (5) Temperature Departures from Normal
- (6) Sea Condition
- (7) Weather Forecasting

2.5 Identification of Season from Weather Map

Climate of India mainly Tropical Monsoon type due to its location. But weather maps of India represent different seasons. The features of the weather elements are different during different season. The identifying features are mentioned here (season wise)—

2.5.1 Winter Season [December to February]:

- (a) Clear sky.
- (b) High Pressure (HP) over North-West parts of India.
- (c) Cold winds comes from the High Pressure belts (Origin of it is Siberia)
- (d) In peninsular India wind movement is from East to West.
- (e) Easterly are full of moisture which yield rainfall over south-east coastal region.
- (f) In North-West region precipitation is caused by depression that are associated with western disturbance moving from Mediteranean sea.
- (g) In this season, Precipitation is moderate to slanty.

2.5.2 Summer Season (Hot weather) [March-May]

- (a) Highest temperature in North India.
- (b) Precipitation occur in coastal area.
- (c) West Bengal, Assam, Burma (Myanmar), Bangladesh receive convectional precipitation. It is also refers as '**Mango Shower**'.
- (d) In the Northern plains convective system produce **Thunder Showering**.
- (e) Sky is covered with cumulonimbus cloud produced by strong convection.
- (f) Other climatic characteristics are **strong quall winds and Dust Storm**.
- (g) These violent dust storm are known as '**Andhi**' or '**Norwester**'. Sometimes accompanied by heavy downpours and afternoon storms.

2.5.3 Rainy Season [June-September] / Monsoon Season :

- (a) Low pressure over North-Western India and High Pressure over ocean.
- (b) By the end of May and first week of June trade wind from southern hemisphere are drawn toward thermal in N.W. region of the subcontinent.
- (c) The southerly trades on crossing the Equator are deflected to right according to **Ferrel's Law**.
- (d) Now the S.E. trade wind become S. Westerly blowing winds towards North-East.
- (e) This season face rainfall across India.
- (f) Coastal areas are overcast or high cloud covered.
- (g) This season is also called **Monsoon Season**.

2.5.2 Post-Monsoon Season (Retreating Monsoon) [October - December]:

- (a) Temperature falls gradually.
- (b) Occasional rainfall occurs.
- (c) Wind blow from westerlies direction in North India.
- (d) In, South India, North-Easterly winds prevail.
- (e) Weakening of Low Pressure over the continent.
- (f) Low Pressure centre of Bay of Bengal.
- (g) Cyclones can be seen on Southern Bay of Bengal.
- (h) Shower occurs in Tamilnadu.
- (i) Monsoon starts to retreat from North West India.

2.6 Weather Symbols

On weather maps for the sake of convenience, rainfall and other elements of weather are represented by symbols or abbreviation of names. Such a system was devised by **Admiral Beaufort** in 1806 and was later modified by him in 1830. The same table is even now being used with a few additions (Table).

Beaufort Notation:

- b : blue sky—to more than a quarter covered with cloud.
- be : sky partly cloudy-one-half covered.

c : generally cloudy—detached opening clouds.
 d : drizzle.
 e : wet air without rain falling, a copious deposit of water on trees, buildings, etc.
 f : fog, visibility 22-1,100 yd.
 fe : wet fog.
 fs : fog over sea (coast station).
 fg : fog on lower ground (inland station).
 F : thick fog, visibility less than 220 yd.
 g : gloom.
 h : hail.
 i : intermittent.
 jp : precipitation within sight of station.
 ks : storm of drifting snow.
 KQ : line squall.
 l : lightning
 m : most, m visibility 1,100 - 2,200 yd.
 o : overcast sky, *i.e.*, the whole sky covered with one impervious cloud.
 p : passing showers.
 q : squalls.
 r : rain.
 s : snow.
 t : thunder.
 tl : thunderstorm.
 u : ugly threatening sky.
 v : unusual visibility of distant objects.
 w : dew.
 x : hoar-frost.
 y : dry air—less than 60 per cent humidity.
 z : haze, range of visibility 1,100 yd or more but less than 2,200 yd.

Table : Forms of Meteorological Symbols approved by the International Meteorological Organisation, Warsaw, 1935

∅	Pure air	∇ ⁺	Shower of Snow	⌋	Hoar Frost
∞	Haze	∇ [*]	Shower of Rain	∞	Glazed Frost
=	Mist		Snow (Sleet)	∇	Soft Rime
≡	Fog v < lkm	⊗	Soft Hail	∇ ⁺	Hard Rime
≡	Shallow Fog	△	Small Hail	⚡	Gale
≡	Ground Fog	▲	Hail	☉	Sunshine
≡	Frost Fog	<	Distant Lightning	⊕	Solar Halo
•	Drizzle	⚡	Thunderstorm	☾	Lunnar Halo
•	Rain	+	Drifting Snow (High up)	☉	Solar Corona
⊗	Snow	+	Snowstorm	☾	Lumar Corona
⊗	Sle	+	Drifting Snow (Near the Ground)	☾	Rainbow
△	Granular Snow	⊗	Dust or Sandstorm	☾	Aurora Borealis
△	Grains of Ice	⊗	Dust Devil	☾	Mirage
	Ice Needles	⊗	Snow Lying	☾	Zodiacal Light
∇ [*]	Shower of Rain	∇			

Capital letters indicate intensity of the phenomenon, and slight intensity by a small suffix a Repetition of letters indicate continuity and intermittence by prefixing the letter i. Thus:

- R : heavy rain.
- r : (moderate) rain.
- or : slight rain.
- RR : continuous heavy rain.
- rr : continuous (moderate) rain.
- iro : intermittent slight rain.

Actual existing weather is demarcated from preceding conditions by a 'solidus', thus, b/r, blue open sky after rain. The sign (–) indicates decrease in the intensity of the particular phenomenon and the sing (+) indicates increase in intensity. A symbol

enclosed within brackets thus: (1) indicates the occurrence of the phenomenon in the vicinity of the station. Indices 0, 1, 2 may be used to denote intensity.

On weather maps in addition to the above observations generally the barometric tendency is also indicated. The stations which are equipped with barographs report the amount and nature of change in pressure in the three hours preceding the time of observation. This rise or fall in pressure is known as the barometric tendency and the nature of the change, whether the fall or rise was continuous or there was first a fall and then a continuous rise or any other variety of change, is known as the “characteristic” which is also reported. If lines are drawn through places having the same tendency we get what are known as isallobars.

In modern weather maps the type of cloud and the individual amounts of different types are also indicated by symbols.

2.7 Reading a Weather Map

Before proceeding to read the Indian Daily Weather Map one should get familiar with the various symbols used on such maps.

The following points are to be described while reading the weather map :

1. Pressure

- (a) location of bar high,
- (b) location of bar low,
- (c) trend of isobars,
- (d) gradient of pressure.

2. Wind

- (a) direction, (b) velocity.

In relation to pressure variation.

3. Sky condition

- (a) cloud cover,
- (b) nature of the cloud,
- (c) other atmospheric phenomena.

4. Precipitation

- (a) general distribution.
- (b) special area of heavy precipitation.

5. **Pressure departure from normal**
6. **Temperature departure from normal**
7. **Sea-condition**

2.8 Some Notes on the Weather Maps of India

With a view, to making improvements in the representation of weather conditions several changes have been introduced in the 'Weather Reports of India' in recent years. Up to the end of the year 1948 the weather maps in the 'Reports' used to show (a) pressure in the millibars, (b) wind direction and speed in miles, (c) rainfall in inches and sea. condition. There was, thus, no indication of clouds cover on the weather-maps. The symbols used were also different from those of later weather maps.

On 1st January, 1949 various new informations regarding cloud cover and other atmospheric phenomena were introduced. The new maps, thus, gave a better picture of the weather conditions than the old maps.

Further modifications, though only minor, have been made since January 1, 1957 so as to represent more clearly the wind condition on the. weather- maps.

2.9 Metric Units for Weather Reports

From 1st January, 1957 weather reports in India are giving rainfall in millimetres, temperatures in degrees centigrade and cloud heights and distances of visibility in metres and so on. Wind speed generally meant for navigational purposes will continue to be printed in knots as hitherto, while those for other purposes will be expressed in kilometres per hour, consequently an inch of rainfall at any station will be reported as 25.4 millimetres of rainfall; 2 inches as 51 millimetres and so on. The conversion is very simple being proportional at a rate one inch = 25.4 millimetres.

In the case of temperature, the conversion is not so simple. To convert degrees Fahrenheit to degrees Centigrade, equations are used.







































































































up to 31st December, 1948	<p style="text-align: center;">WIND</p> <p>X 0 – 1 mile per hour  49 – 56 miles per h.</p> <p> 2 – 3 miles " "  57 – 65 " " "</p> <p> 4 – 7 " " "  Above 65 " " "</p> <p> 8 – 11 " " " "</p> <p> 12 – 16 " " " "</p> <p> 17 – 21 " " " "</p> <p> 22 – 27 " " " "</p> <p> 28 – 33 " " " "</p> <p> 34 – 40 " " " "</p> <p> 41 – 48 " " " "</p>		<p style="text-align: center;">RAIN</p> <p>0 – 09" neglected</p> <p> .10" – .17"</p> <p> .18" – .37"</p> <p> .38" – .67"</p> <p> .68" – .87"</p> <p> .88" – .124"</p> <p> 1.25" – 1.74"</p> <p> 1.75" – 2.50"</p> <p> 2.51" – 3.49"</p> <p style="text-align: center;">8c. 8</p>																																	
	<p style="text-align: center;">SEA CONDITION</p> <p>Cm Calm</p> <p>Sm Smooth</p> <p>St Slight</p> <p>Mod moderate</p> <p>Ro rough</p> <p>V. Ro very rough</p> <p>Hi high</p> <p>V. Hi V. high</p> <p>Ph phenomenal</p>																																			
Since 1st January, 1949	<p style="text-align: center;">WIND</p> <p> Less than 3 knots</p> <p> 5 knots</p> <p> 10 knots</p> <p> 15 knots</p> <p> 20 knots</p> <p> 50 knots</p> <p style="text-align: center;">RAIN FALL</p> <p>less than 9 cm neglected</p> <p>- = 0.10 to 0.17 cm rest actual amount plotted out side the circle.</p>	<p style="text-align: center;">CLOUD</p> <table border="1"> <thead> <tr> <th>Amount</th> <th>low or medium</th> <th>High</th> </tr> </thead> <tbody> <tr> <td>Sky covered</td> <td></td> <td></td> </tr> <tr> <td>1/8 "</td> <td></td> <td></td> </tr> <tr> <td>1/4 "</td> <td></td> <td></td> </tr> <tr> <td>3/8 "</td> <td></td> <td></td> </tr> <tr> <td>1/2 "</td> <td></td> <td></td> </tr> <tr> <td>5/8 "</td> <td></td> <td></td> </tr> <tr> <td>3/4 "</td> <td></td> <td></td> </tr> <tr> <td>7/8 "</td> <td></td> <td></td> </tr> <tr> <td>overcast</td> <td></td> <td></td> </tr> <tr> <td>sky obscured</td> <td></td> <td></td> </tr> </tbody> </table> <p style="text-align: center;">Sea condition shown as above</p>	Amount	low or medium	High	Sky covered			1/8 "			1/4 "			3/8 "			1/2 "			5/8 "			3/4 "			7/8 "			overcast			sky obscured			<p style="text-align: center;">WEATHER</p> <p> Haze</p> <p> Dust Devil</p> <p> Mist</p> <p> Shallow Fog</p> <p> Fog</p> <p> Squal</p> <p> Dust or Sand storm</p> <p> Drifting snow</p> <p> Hail</p> <p> Drizzle</p> <p> Rain</p> <p> Snow</p> <p> Shower</p> <p> Thunder storm</p> <p> Lightning</p>
	Amount	low or medium	High																																	
Sky covered																																				
1/8 "																																				
1/4 "																																				
3/8 "																																				
1/2 "																																				
5/8 "																																				
3/4 "																																				
7/8 "																																				
overcast																																				
sky obscured																																				
Since 1st January, 1957	<p style="text-align: center;">WIND</p> <p> 5 knots</p> <p> 10 knots</p> <p> 15 knots</p> <p> 50 knots</p> <p style="text-align: center;">Rainfall in cm</p> <p>- = 0.25 to 0.44 cm</p>	<p>In 1730 hrs. weather maps, rainfall amounts indicated refer to past 9 hours.</p> <p>In 0830 hrs. weather maps, rainfall amounts indicated refer to past 24 hours.</p>																																		
	cloud, weather 8 sea conditions shown as above.																																			

Fig. 2.8

2.10 Weather Map Interpretation

2.10.1 Introduction

The supplied weather map of wednesday, 22nd May 1985 indicates the weather condition of the Indian subcontinent recorded at 08.30 Hrs. I.S.T., 03.00 HRS. G.M.T. This weather map indicates pre-monsoon due to the following characteristics—

- (a) Low pressure over the landmass that means the temperature over landmass is high as the position of the sun is in the Northern Hemisphere.

INDIAN DAILY WEATHER REPORT WEATHER MAP AT 0830 HRS I.S.T. (0800 HRS. G.M.T.)

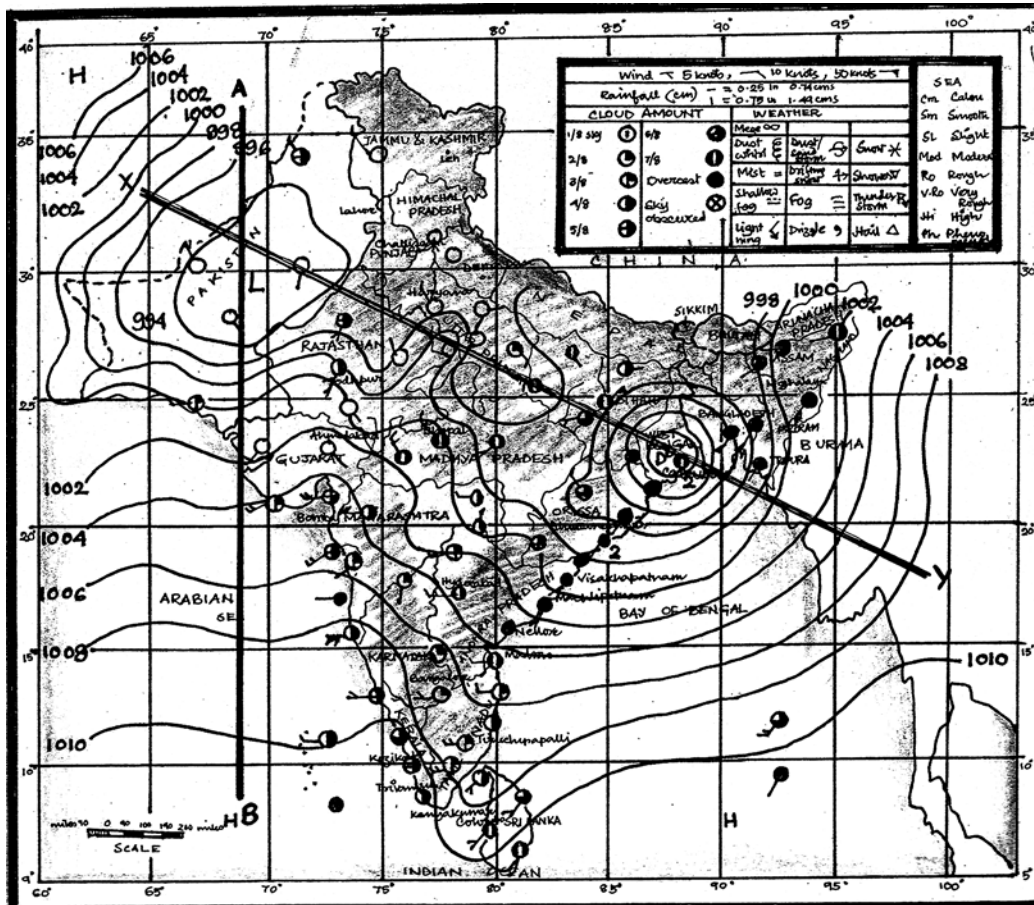

Fig. 2.9

- (b) Trend of isobars are decreasing from South to North.
- (c) The direction of wind is more from West and Southwest direction.
- (d) Cloud cover is getting throughout India, as it covers almost South India.
- (e) Rainfall is not high over North-west India.

On the basis of these characteristics the weather map clearly indicates summer season.

2.10.2 Pressure:

Pressure variation is quite prominent all over the country. This variation of pressure is mostly dependent on the angle of insolation, humidity, altitude and rotational movement of the earth. Moreover, because of peninsular location, humidity varies and due to topography altitudinal variation creates condition for pressure variation on the basis of the variation of pressure, various area of low pressure and high pressure can be flow over the Indian subcontinent.

- (i) **Areas of low pressure:** There is one low pressure zone that has developed over the North-Western part of India, over Afganistan and parts of Pakistan. This low pressure zone is surrounded by the isobar of **994mb** and is oval in shape. However apart from this low pressure zone, there is a **depression** that has developed over **Bay of Bengal**. This depression is could due to closely association of isobars of **996mb, 998mb, 1000mb, 1002mb**. The isobars are more or less **circular to semicircular** in shape.

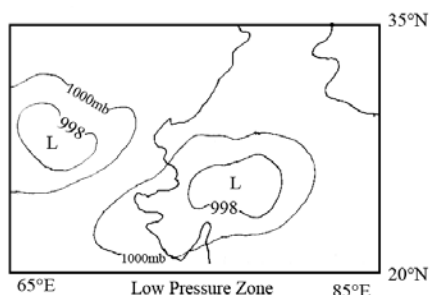

This pressure condition is due to—

- (i) Relative position of the sun over Northern hemisphere vertical rays follows over of the Tropic of Cancer.
- (ii) Humidity is high.
- (iii) Inland location of the areas.

- (ii) **Areas of High Pressure:** As summer season so the relative position of the sun is over northern hemisphere and thus temperature over the landmass is higher confared to that of the oceans. Hence the temperature over oceans on watermass is comparatively low thus creating high

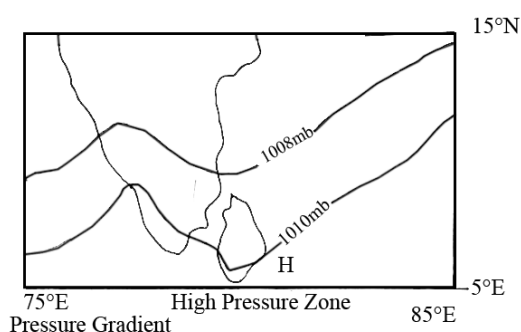

pressure zones over the watermass. There are two high pressure zones that can be seen over the water masses. One of them occurs over the **Arabian Sea** and stretches upto the **Indian Ocean**, towards South-West India and is surrounded is the isobar of **1010mb**, elongated in shape however the second high pressure zone can be scan to the extream part of the Indian subcontinent and east of **Myanmar** or **Burma**. It is also surrounded by **1010mb**, isobar and stretching in North-South direction than irregular manner. Factors responsible— (a) Relative position of sun (b) Humidity low, (c) Location over water.

(iii) **Pressure Gradient:** From this section are can came to the conclusion that the pressure gradient is more or less **gentle** over the **North and Nonth-Western part** of the subcontinent in Pakistan, Rajasthan M.P. etc. overs as the spacing of the isobars are wide enough. But gradually decrease towards Bay of Bengal, we can see that the isobars over closely attached to each other and hence more is a steep pressure gradient as have develops a depression are Bay of Bengal. **Moderate pressure gradient** can be seen over the central India.

PRESSURE GRADIENT

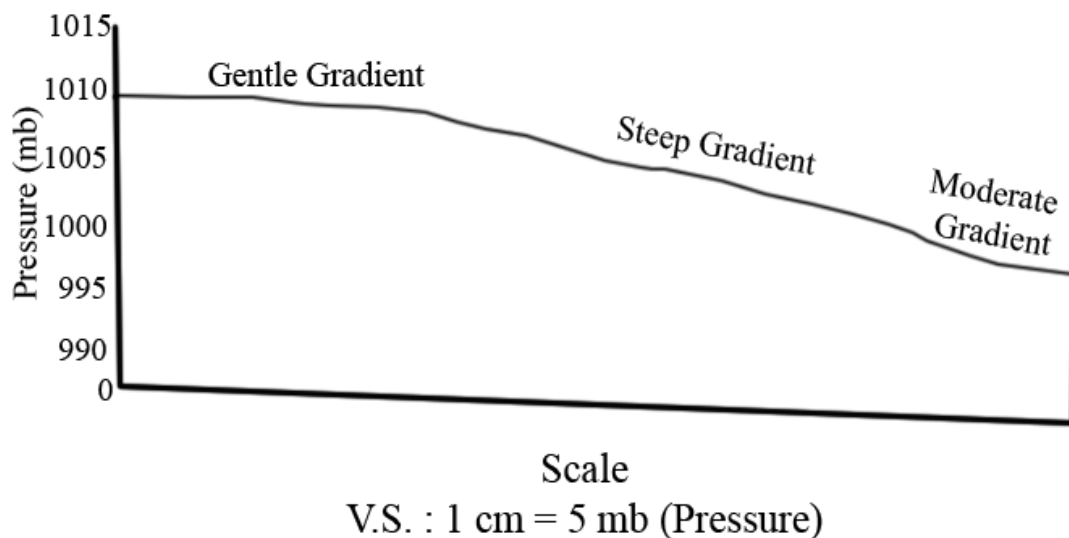

(iv) Trend of Isobars: The trend of isobars with its value decreasing from South

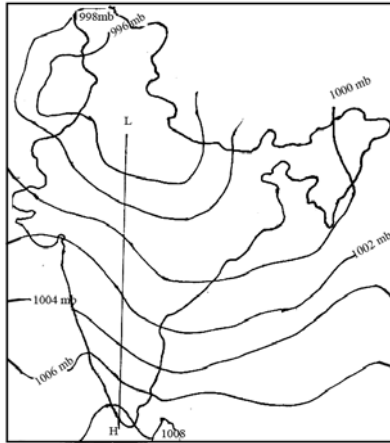

to North constitute of in low pressure zone over North-West India and a depression in Bay of Bengal. There is also two high pressure zone found in South India and extream Eastern of India. The usual trend of isobars is from West to East. The isobars of LP. zones are irregular to oval in shape and gradually towards south, the isobars stretches from West from where it takes a south ward bend toward Tamil Nadu and further thus back towards Meghalaya over Bay of Bengal. The isobars over the oceanic zone is circular to semi-circular in shape.

2.10.3 Wind Condition:

Wind system of any region is dependent on over of location of H.P. and areas of L.P. as winds blows from H.P. zone to L.P. zone. Generally winds are deflected to the right in N.H. (Northern Hemisphere) and left in S.H. (Southern Hemisphere) ace to series low. Thus the wind blows of the subcontinent is due to two characteristics—

- (i) Wind Direction
- (ii) Wind Velocity.

(i) Wind Direction: In keeping with the general law of wind motion, the winds

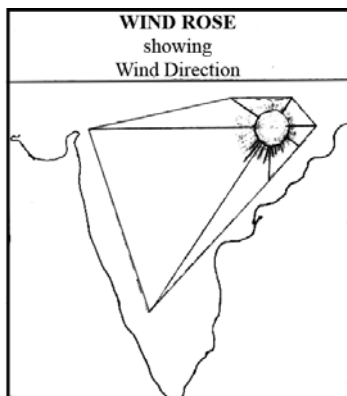

move from H.P. to L.P. areas in this map. The winds over the subcontinent has predominantly blows from West and South-West direction. Specially over West and South India that is areas near **Maharashtra, Andhra Pradesh, Karnataka, Tamil Nadu, SriLanka, Now India over Rajasthan, Gujrat** etc., the wind blowing from West, South and S.W. directions mostly. However, over East and North East India and also North, the winds are blows from **East and South-East** direction. Near **Puna, Meghalaya, Assam, West Bengal, J & K, U.P.,**

M.P., Orissa. The areas of H.P. is found in N.E. and E. India and L.P. zone over the Bay of Bengal.

The dominance of wind blowing from West to South-West direction can be obtained with the help of statistical method—

Wind Direction	Tally	Frequency
N		3
NE		3
E		9
SE		7
S		4
SW		12
W		13
NW		4
		N = 55

N	NE	E	SE	S	SW	W	NW	No. of days	Calm days
3	3	9	7	4	12	13	4	55	4.62

On the basis of the above statistical data wind direction in the particular day can be divided into four major zones of wind direction—

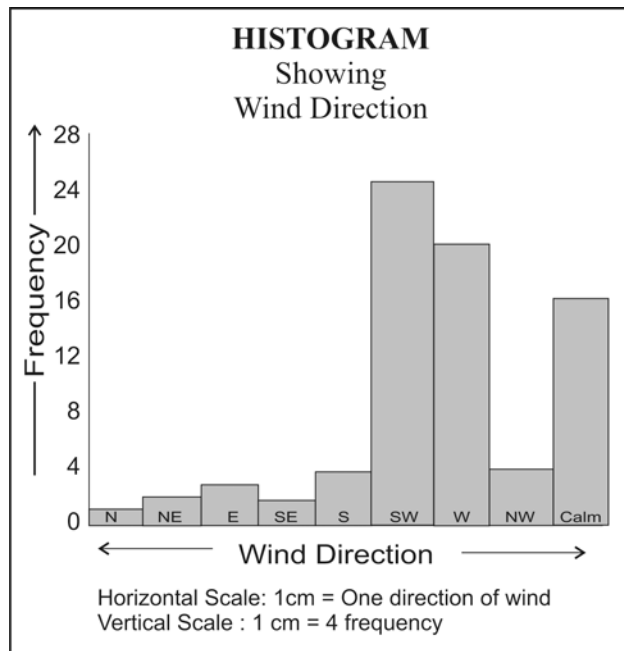

(ii) Wind Velocity: This wind velocity over the subcontinent depends on the pressure gradient over the subcontinent. Since the pressure gradient varies from gentle to steep, hence wind velocity is slightly high over the water mass, however over the landmass, the wind velocity is more or less gentle, where the isobars are closely associated to each other. The pressure gradient is steep and hence the wind velocity is slightly high. However, the wind velocity of the subcontinent of this particular day can be analysed with the help of following statistical method :—

Wind Velocity (in knots)	Tally	Frequency
< 5		11
5-10		25
10-15		16
> 15		3
		N = 55

The statistical method clearly indicates that the wind velocity is more or less moderate to high as it varies between 5 knots to 15 knots. However, it is found that this wind velocity in all over India and thus the landmass has a moderate wind velocity and that of the watermass, the wild velocity is quite high specially along the of strata Arabian sea and east of Srilanka. Thus, based on the above obtaced data, three wind velocity zones can be obtained—

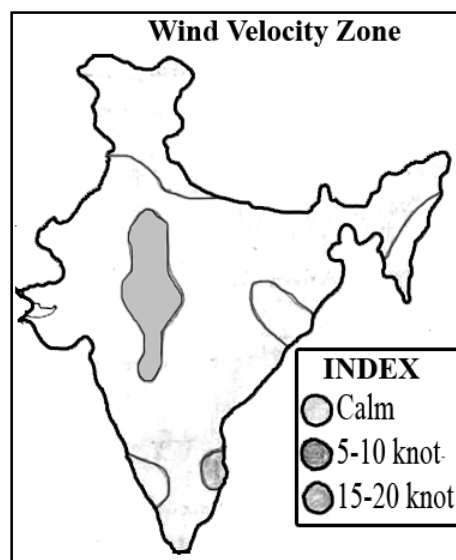

The wind velocity is quite low over North and North West India. Specially near **Pakistan, Rajasthan, J & K, U.P., M.P. and Gujrat**, also in the central part near east of **Maharashtra, parts of M.P., Meghalaya Plateau, Assam** and also towards the eastern coast. The wind velocity gradually increases towards the coastal areas of S. India near **Andhra Pradesh, Tamil Nadu, Karnataka, Kerala coast** wind velocity decreases gradually towards Bay of Bengal and over Andaman & Nicobar island, South East of Sri Lanka. Thus, the wind velocity over the subcontinent can be analysed with the help of the following statistical method (Histogram)—

**Histogram with Polygon
Showing
Wind Velocity)**

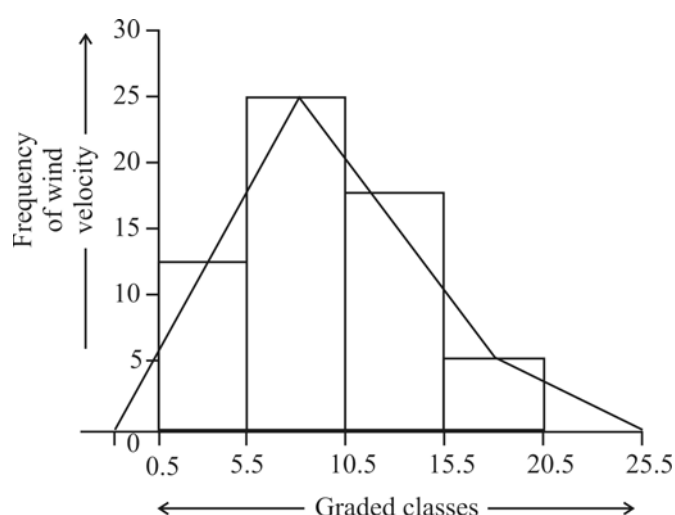

2.10.4 Sky Condition

Nature of Cloud and Cloud Cover: The nature of high, medium and low clouds which are responsible for pattern of rain with their location should be mentioned.

Distribution of cloudiness is discussed and analysed. In the present map, peninsular India, Indian ocean, arabian sea & bay of bengal are recorded overcast. It shows nearly 100% of the stations completely overcast while about 25% stations are absolutely clear sky. (Jammu & Kashmir, Punjab, Haryana, Rajasthan, Uttar Pradesh) This cloud cover may caused by—

(i) The Arabian and Bay of Bengal branches of S.W. Monsoon are moist and rainbearing by nature.

(ii) Regional difference of weather condition.

Database for cloud coverage:

Cloudiness	Blue Sky	$1/8^{\text{th}} - 3/8^{\text{th}}$	$4/8^{\text{th}} - 5/8^{\text{th}}$	$6/8^{\text{th}} - 7/8^{\text{th}}$	Overcast
Index	○	☉ ☌	☌ ☌	☌ ☌	●
Tally					
Frequency	12	7	8	19	5
%Frequency	23.5	19.7	15.7	37.3	9.8

CLOUD COVER ZONE

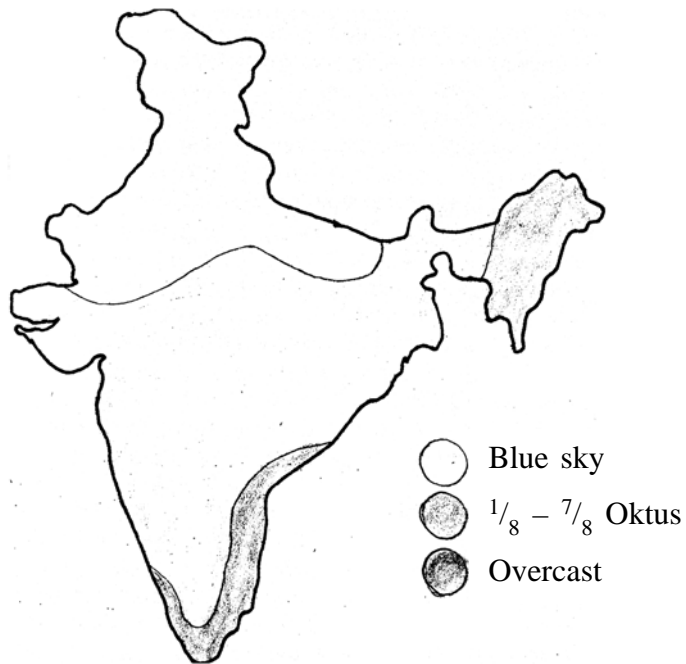

**BAR GRAPH
Showing
Cloud Cover**

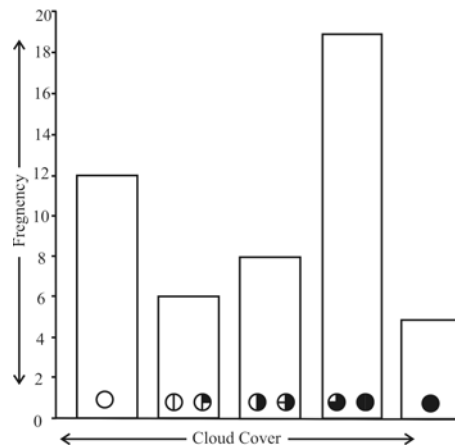

2.10.5 Rainfall:

In the present weather map, some scattered rainfall was observed in Karnataka, Tamil Nadu, Kerala, Andhra Pradesh and Meghalaya and Tripura. Other parts of India remained fairly dry. The rainfall has been widespread over Goa-Cochin (2 cm) & Tripura (1 cm) due to the moist S-W Monsoonal branches.

**BAR GRAPH
Showing
Rainfall Distribution in India**

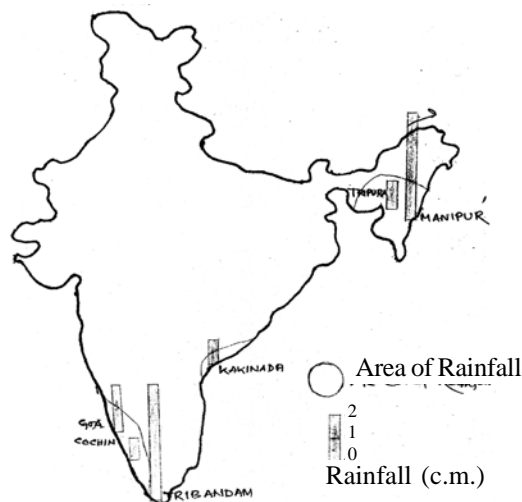

2.10.6 Pressure-Wind-Cloudiness-Rainfall Relation:

The origin of the S-W monsoon was influenced by the low pressure over the N-W part of the subcontinent. Here, the Bay of Bengal branch is southerly, while Arabian Sea branch is mostly westerly. Therefore, rainfall has been concentrated over the windward slope of the orographic barriers. The mentioned two branches of monsoon meet along the axis along which depressions are move affecting the rain.

2.10.7 Other Atmospheric Phenomena:

Here, haze, sandstorm, duststorm and drizzde are observed in some places. U.P., M.P., Andhra Pradesh, Orissa observed haze, whereas Rajasthan experience duststorm and sandstorm.

2.10.8 Sea Condition:

It represents the nature of sea. This condition fluctuated between calm and slight and it is mostly determined by the wind velocity and pressure. Here, the southern part of ocean over the Indian ocean was moderately disturbed (moding), whereas, the western part of Arabian Sea and places near SriLanka was quite rough ($R_0 \rightarrow$) by nature. The sea of other portions was smooth.

SEA CONDITION

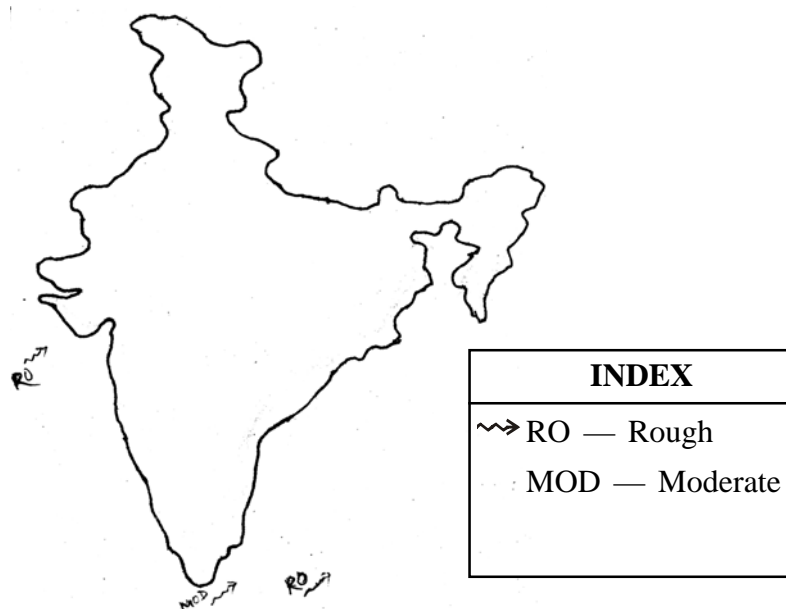

2.10.9 Weather Forecasting:

A short-range forecast for the next 24 to 48 hours may be made on the basis of above analysis, as follow:

- 1) The night temperature are likely to increase at some places — (Maharastra, M.P., Bihar, Karnataka) due to high cloud cover.
- 2) The minimum temperature is likely to increase over the semi-arid and arid regions which indicates a stormy weather.
- 3) The pressure is likely to romalise over most of the area.
- 4) Light and scattered rainfall may occur at Kerala, Tamil Nadu, Andhra Pradesh, Tripura and Manipur and North Eastern Hill states.
- 5) Jammu & Kashmir, Rajasthan, H.P., may experience a fair and clear sunny sky.
- 6) Due to the moderate to rough sea conditions, fishermen of those areas are requested not to go for fishing.

WEATHER FORECASTING

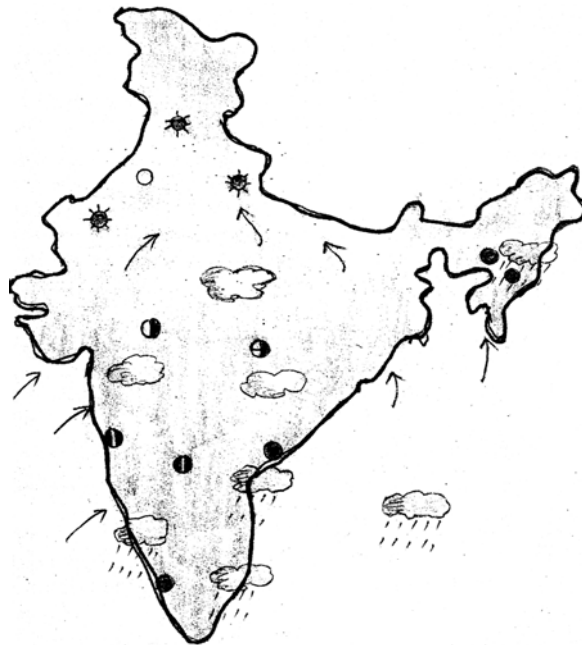

2.11 Indian Daily Weather Report

It is a six-page report and is published every day by the Meteorological Office, Pune. It contains a summary of observations, a forecast of weather, meteorological data of a large number of stations, coded messages and two weather maps.

The report gives a summary of the observations recorded at 0830 hours I.S.T. The summary includes a brief account of the dominating pressure systems, rainfall received during the past 24 hours, departure of maximum temperature and minimum temperature from normal and a forecast of weather valid until the evening of the next day.

In addition to a brief summary of the weather, wireless reports from ships and coded messages received from various stations are given. The coded messages pertain to cloud amount, direction of wind, speed of wind in knots, visibility present and past, weather regarding rain and snow, barometric pressure, temperature, cloud amount with height, cloud type, change in barometric pressure recorded at 0830 hours of the date on which the report was published and at 1730 hours of the previous day, etc. The coded messages relate to the observations recorded at 1730 hours of the previous day and at 0830 hours of the date of the publication of the report.

The report also includes temperature and rainfall data of all those stations of which coded messages are given. Maximum and minimum temperatures in °C and their departure from normal, rainfall of past 24 hours in millimetres, season's total in mm. year's total (from 1 January), in cm. and annual normal rainfall in cm. are given.

Two weather maps of India and the neighbouring countries, one depicting the weather at 0830 hours on the day of the publication of the weather report and the other depicting the weather at 1730 hours of the previous day are also attached to the report. At the bottom of the weather map showing the weather at 0830 hours, there are two small maps of India, one showing the departure of minimum temperature from normal and the other departure of pressure recorded at 0830 hours from normal. The rainfall amounts given in the weather map showing the weather at 0830 hours, are those received during the past 24 hours.

At the bottom of the weather map showing the weather at 1730 hours, there are also two small maps of India but one showing the departure of maximum temperature from normal and the other depicting winds, fronts and discontinuities at 1.5 km. above the mean sea-level at 1730 hours. The rainfall amounts given in the weather map depicting the weather at 1730 hours are those received during the past 9 hours only.

2.12 Weather Elements in a Weather Map/Report

A map showing the distribution of weather elements for a given time, is called a *weather map*. The weather elements are represented on a weather map by symbols. Knowledge of these symbols is essential for making an attempt to study a weather map.

A weather map is studied systematically as under:

1. Introduction. Give the time at which the weather observations were recorded and the date. Also make a brief mention of the special weather conditions represented on the two small-sized maps given at bottom of the main weather map of India and the neighbouring countries.

2. Barometric pressure.

- (i) Areas of high pressure,
- (ii) Areas of low pressure,
- (iii) Pressure systems,
- (iv) Trends of isobars,
- (v) Pressure gradient.

Pressure is represented by isobars drawn at an interval of 2 mb. A close look at the weather map indicates that the isobars assume certain shapes. Locate the highest and the lowest pressures and various pressure systems namely cyclones, anticyclones, wedge, col, etc. 'L' is placed in the centre of a low pressure area. 'H' in the centre of a high pressure area and 'D' in the centre of a depression. Mention the direction which the isobars run. Also identify the areas where pressure is uniformly the same and where the pressure falls rapidly. The rate of fall of pressure between two points is called *pressure gradient* or *barometric gradient*. Where the isobars are close together pressure gradient is steep and where the isobars are wide apart, it is gentle. The maximum gradient is along the line perpendicular to the isobars. Where the gradient is gentle the wind is weak and where the gradient is steep it is strong.

3. Wind

- (i) Direction, (ii) Velocity.

The direction of the wind is controlled by various pressure systems (Fig.) and it should be studied in relation to these systems. The direction of the wind is indicated by a line one end of which meets a circle drawn at the station where the wind direction was recorded. The direction from which the line comes to meet the circle indicates the direction of the wind. The wind velocity is shown by barbs (feather lines) attached to the line indicating the direction of the wind (Fig.). The velocity of the wind is given in knots (page 320). Cyclonic storms if any should also be identified.

4. Cloud Cover

- (i) Cloud amount, (ii) Type of the cloud.

Mention how much of the sky is covered with clouds in the various parts of the country. Also indicate whether the cloud is high, low or medium.

5. Rainfall

- (i) Distribution, (ii) Areas receiving exceptionally heavy rainfall.

Rainfall is given in centimetres and is written close to the south-eastern side of the circle. The weather map depicting the weather at 0830 hours gives the rainfall received during the past 24 hours. The weather map depicting the weather at 1730 hours gives the rainfall received during the past 9 hours only (Fig.) A black dot indicating that it was raining when the map was drawn is placed near the western side of the circle. Identify the areas which have received exceptionally heavy rainfall giving the probable causes. Describe and explain the distribution of rainfall throughout India and the neighbouring countries.

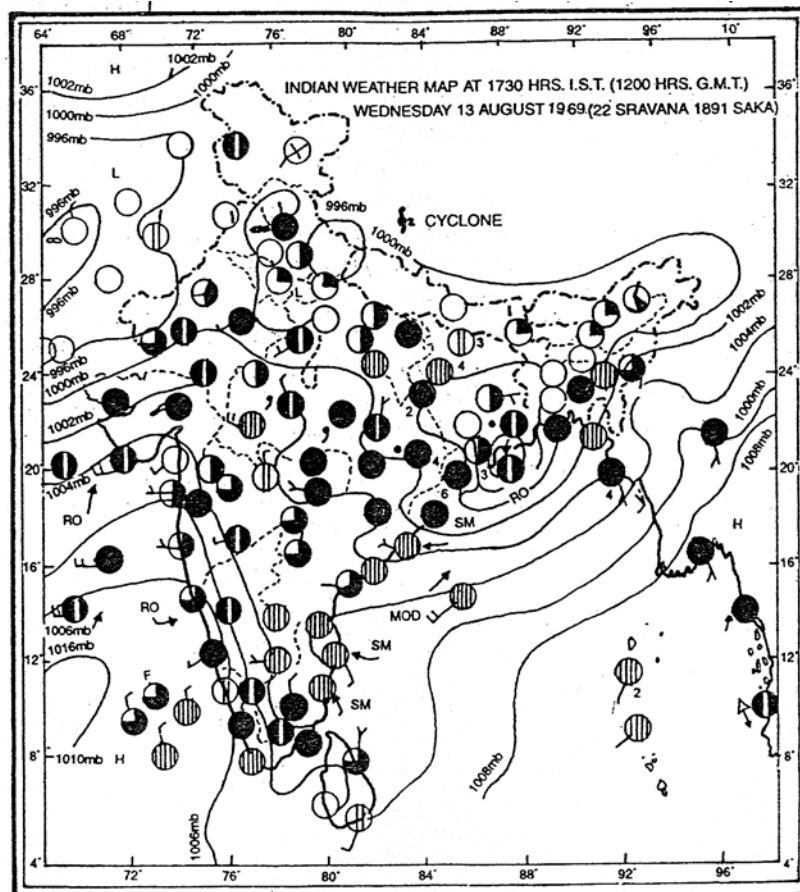

6. *Other Weather Phenomena*

Mention the distribution of haze, dust-whirl, mist, shallow fog, lightening, squall, dust or sandstorm, drifting snow, fog, drizzle, rain, snow, shower, thunderstorm and hail.

7. Departure of minimum temperature from normal.
8. Departure of maximum temperature from normal.
9. Departure of pressure from normal.
10. Sea condition.

2.13 Exercise of Weather Maps

1. What is a weather map? What does it portray? Why it is important to geographers?
2. Name the instruments that record atmospheric. temperature, pressure, wind velocity, wind direction, cloudiness, sunshine, rainfall, evaporation, and evapotranspiration.
3. Name the Headquarters of IMO and WMO.
4. Name the different types of weather recording stations in India.
5. Define atmospheric pressure. State the units of its measurement.
6. Name the different climatological seasons along with their duration in India.
7. What are the salient features of weather observed during the hot weather season in India?
8. What are the salient features of weather observed during the cold weather season in India?
9. What are the salient features of weather observed during the southwest monsoon season in India?
10. What are the salient features of weather observed during the retreating monsoon season in India?
11. Critically study the isobaric pattern in the weather map. Identify the trends of isobars and explain it.
12. State the salient characteristics of the weather, elements as shown in the given weather map and identify the seasons.
13. Draw a sketch map to show the areas of high pressure and low pressure and the trends

of isobars with such features as axis of low pressure, axis of monsoon trough, wedge of high pressure, cyclonic circulation and the general pattern of isobars. .

14. What is meant by pressure gradient? How it is measured, on a weather map? Find the directions and magnitudes of the steepest, gentlest and average pressure gradient shown on the given weather map.
15. Draw isobaric sections along suitable directions on the given weather of pressure gradient. Explain it.
16. For, the given weather map draw a wind rose and analyse it to identify the season.
17. State the laws relating to wind direction. Draw a sketch map to show the different zones and interpret it.
18. Draw a statistical diagram to analyse the distribution of wind velocity over a given weather map.
19. Draw a sketch map to show the distribution of different wind velocity zones and interpret it.
20. Draw a statistical diagram to analyse the distribution of cloudiness over a given weather map.
21. Draw a sketch map to show the distribution of zones of different cloudiness and interpret it.
22. Draw a sketch map to show the distribution of rainfall, and interpret it.
23. Draw a sketch map to show the distribution of different sea conditions and interpret it.
24. Draw a transect chart to illustrate the relation between pressure gradient and wind velocity.
25. With the help of a transect chart, explain the relations between pressure condition wind condition, cloudiness, rainfall and other atmospheric phenomena.
26. Interpret the weather map under the heads pressure conditions, wind conditions cloud cover and rainfall. Comment on the weather conditions that would be most likely in the next 24-48 hours.
27. Critically analyse the weather conditions portrayed in the weather map and identify the season.

Exercise:

Map 1

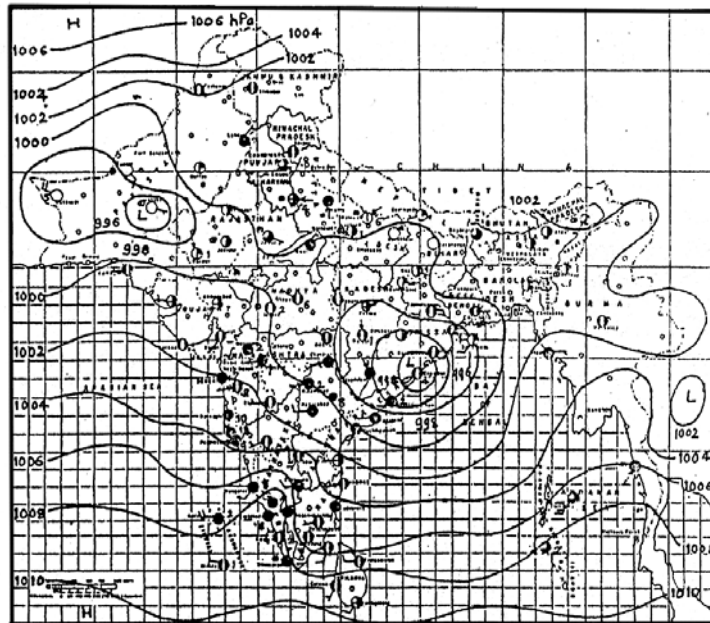

Map 2

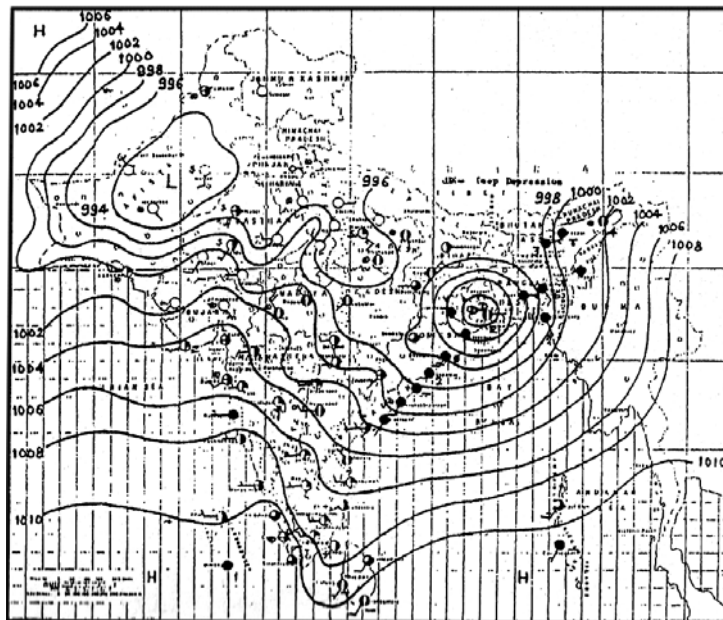

Map 3

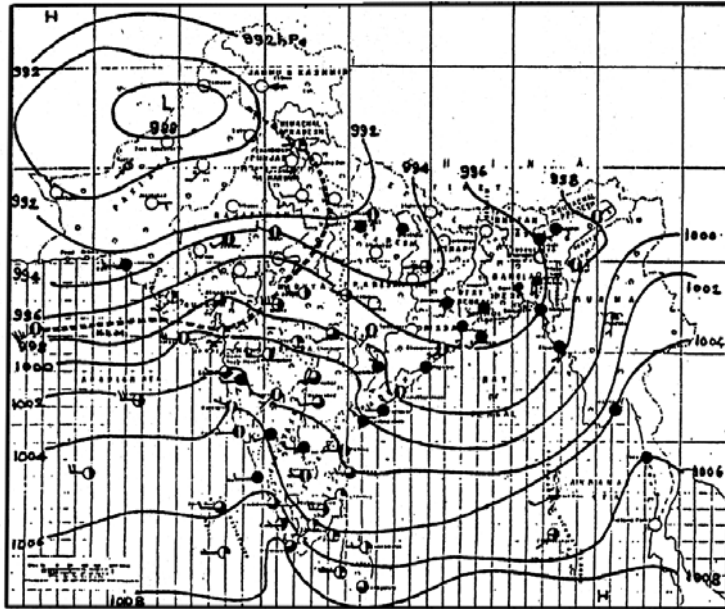

Map 4

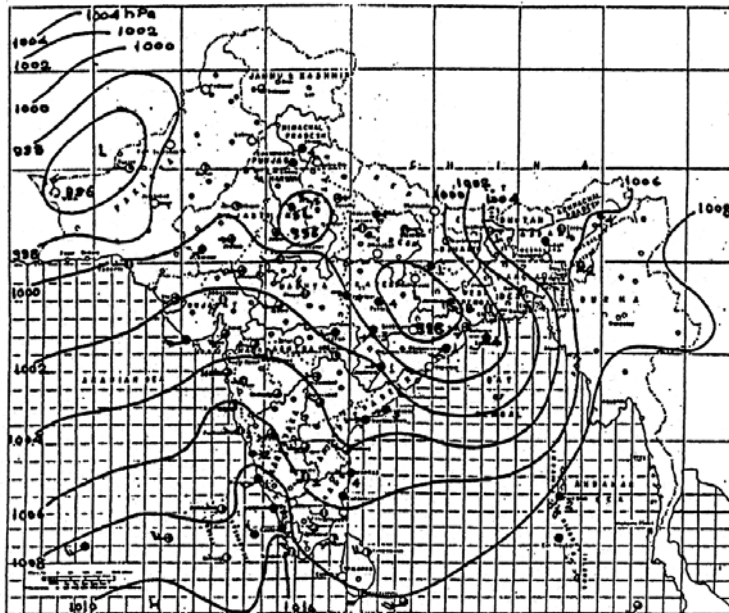

Map 5

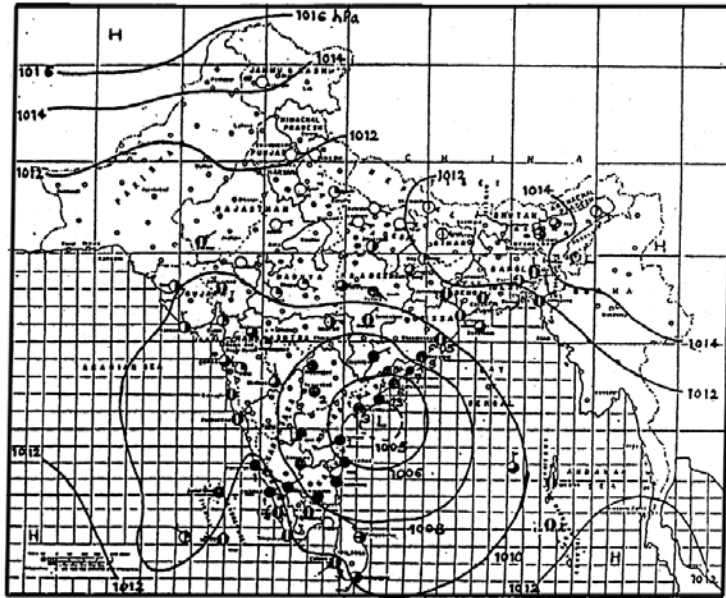

Map 6

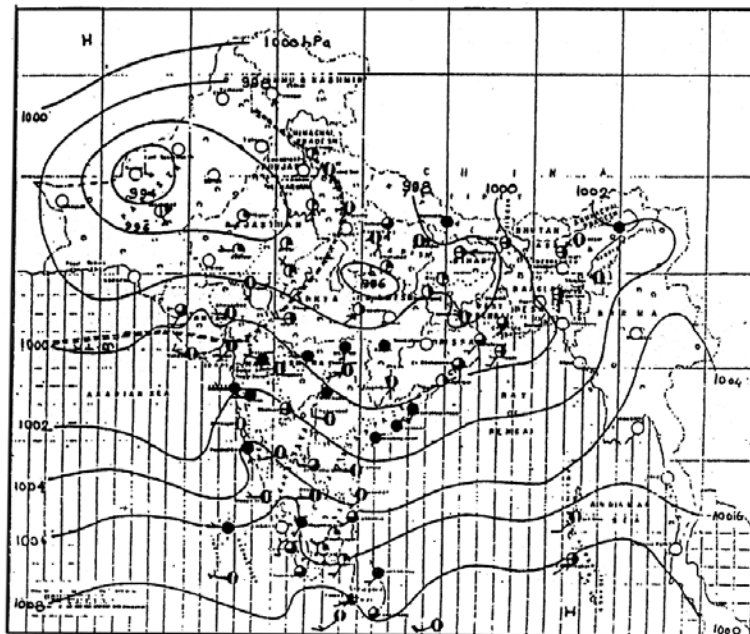

Unit 3 □ Construction and Interpretation of Climograph (G. Taylor)

Structure

- 3.1 Introduction
 - 3.2 Construction
 - 3.3 Uses
 - 3.4 Structure
 - 3.5 Examples
 - 3.6 Exercise
-

3.1 Introduction

G. Taylor, in 1949, introduced a climatic diagram to represent mean-monthly values of wet bulb temperature ($^{\circ}\text{C}$) and relative humidity (%) on a fixed frame.

3.2 Construction

(1) In the fixed rectangle or square frame, wet bulbs temperature in plotted along the y-axis (from -10°F to 90°F) while the relative humidity is plotted along the x-axis (graduated from 20% to 100%).

(2) The four corners of the frame are marked as **Row** in South-East (SE), **Muggy** in North-East (NE), **Scorching** in the North-West (NW) and **Keen** in the South-West (SW).

(3) The diagram represents—

Item	Represents	Do notes
(i) Raw	low wet-bulb	(< 40°F) & high relative humidity (over 70%)
(ii) Muggy	high wet-bulb	(> 60°F) & high relative humidity (over 70%)
(iii) Scorching	high wet bulb	(> 60°F) & low relative humidity (below 40%)
(iv) Keen	low wet bulb	(< 40°F) & low relative humidity (below 40%)

(4) A scale of discomfort is marked on the right of the rectangular frame. The scale values are—

Discomfort	Features
(i) Very rarely uncomfortable	Below 45°F
(ii) Ideal	45° - 55°F
(iii) Rarely uncomfortable	55° - 60°F
(iv) Sometimes uncomfortable	60° - 65°F
(v) Often uncomfortable	65° - 70°F
(vi) Usually uncomfortable	Above 70°F

(5) Within the frame, the name of the months need to be write shortly after plotting the points by measuring the web-bulb temperature and relative humidity of each months.

(6) The plotted points of each months should be joined gradually by the straight lines which finally represent the **Polygonal Climograph**.

(7) Finally, analyse or interpret the polygonal climographs on the basis of its location (located in which corners of the frame) and shape.

3.3 Uses

- (1) It is used to indicate the physiological effects of climate on man.
- (2) It represents the discomfort level of climate.
- (3) Different zones or pattern of uncomfortableness can be best understood by climograph.

3.4 Structure

* **Climograph (The Taylor type):**

Name	Position	Wet bulb Temperature (°F)	Relative Humidity (%)
Raw	South East (SE) Corner	Below 40°F	Over 70
Muggy	North East (NE) Corner	Over 60°F	Over 70
Scorching	North West (NW) Corner	Over 60°F	Below 40
Keen	South West (SW) Corner	Below 40°F	Below 40

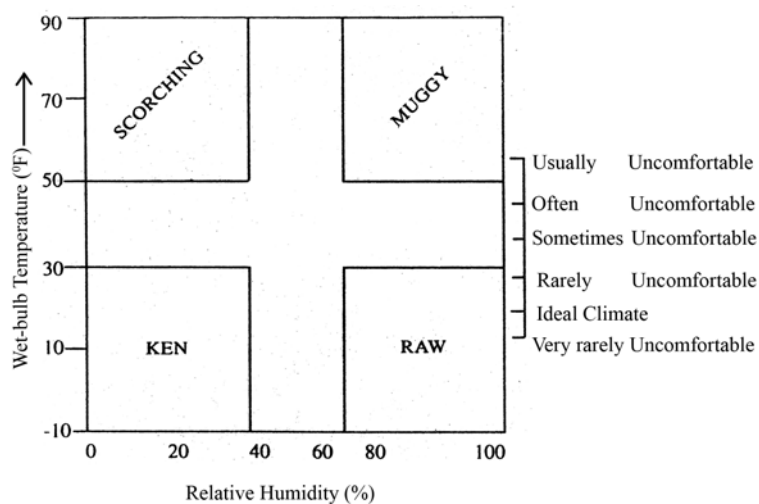

Fig. : Structure of Climograph

3.5 Examples

(a) **Example-1:** Draw 'Climograph' on the basis of the given data and also identify the climatic type.

Month	J	F	M	A	M	J	J	A	S	O	N	D
Wet-Bulb Temp. (°F)	33.6	36.3	42.2	50.2	59.2	65.7	68.9	67.9	64.4	54.9	45.4	38.5
Relative Humidity (%)	78	73	65	57	58	42	52	57	38	55	44	48

N.B.: $\frac{C}{5} = \frac{F-32}{9}$

(b) **Example-2:** Draw 'Climograph' on the basis of the given data.

Month	J	F	M	A	M	J	J	A	S	O	N	D
Wet-Bulb Temp. (°F)	64.8	68.5	70.5	78.1	82.9	82.3	80.8	80.7	80.5	78.0	68.9	68.4
Relative Humidity (%)	40	44	38	38	57	69	81	79	75	72	48	48

CLIMOGRAPH (After G. Taylor)

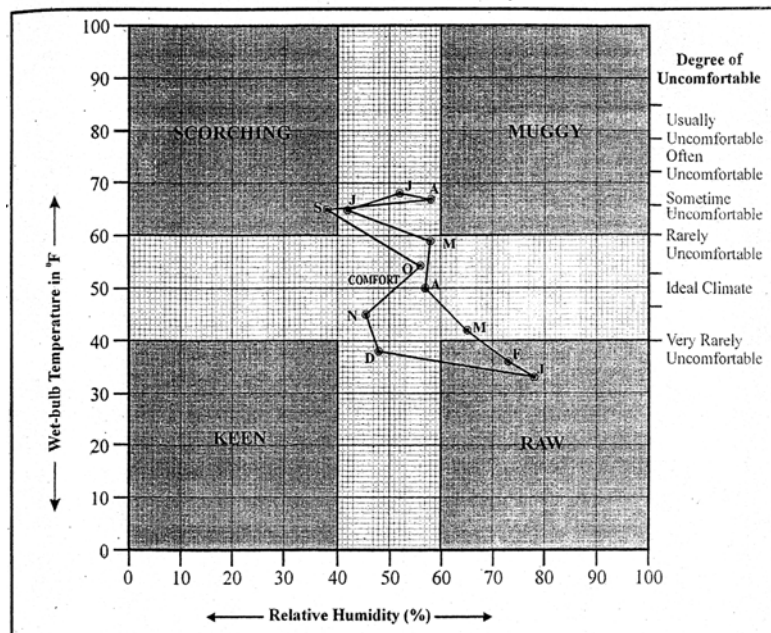

CLIMOGRAPH (After G. Taylor)

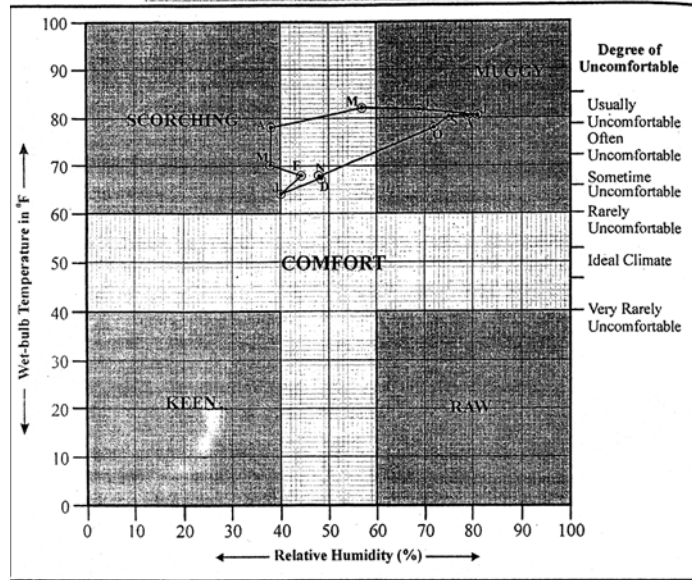

C) Example 3 : Data for Climograph of Kolkata:

Month	J	F	M	A	M	J	J	A	S	O	N	D
Wet-Bulb Temp. (°F)	65	69	71	78	83	82	81	81	80	78	69	68
Relative Humidity (%)	40	44	38	38	57	69	81	79	75	72	48	48

CLIMOGRAPH OF KOLKATA
[After G. Taylor]

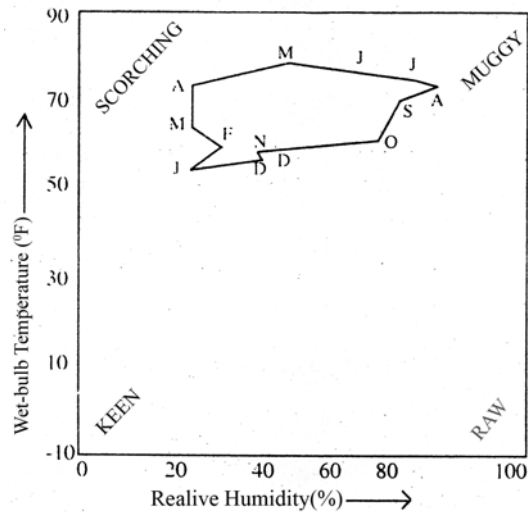

Fig. : Climograph of Kolkata

3.6 Exercise

CLIMOGRAPH

Draw 'Climograph' on the basis of the given data, also identify the climatic type:

Month	J	F	M	A	M	J	J	A	S	O	N	D
Wet-Bulb Temp. (°F)	35.3	38.3	42.2	32.3	59.2	67.7	69.9	68.9	67.9	64.2	55.2	40.5
Relative Humidity (%)	80	78	66	58	45	54	53	40	52	45	46	50

Draw 'Climograph' on the basis of the given data also identify the climatic type:

Month	J	F	M	A	M	J	J	A	S	O	N	D
Wet-Bulb Temp. (°F)	53	55	58	61	66	71	77	78	75	68	62	57
Relative Humidity (%)	49	44	45	47	51	55	57	73	77	76	78	79

Draw a climograph with the help of following data. Identify the climatic type.

Month	J	F	M	A	M	J	J	A	S	O	N	D
Wet-Bulb Temp. (°F)	45	46	56	64	63	61	59	52	50	49	43	42
Relative Humidity (%)	35	36	61	62	66	70	75	80	79	67	55	38

Draw a climograph with the help of following data. Interpret the diagram.

Month	J	F	M	A	M	J	J	A	S	O	N	D
Wet-Bulb Temp. (°F)	8	12	18	18.5	19.6	19.8	20.1	17	17.5	16.9	09	07
Relative Humidity (%)	61	60	55	54	49	71	83	84	70	68	64	58

Draw a climograph with the help of following data. Interpret the diagram.

Month	J	F	M	A	M	J	J	A	S	O	N	D
Wet-Bulb Temp. (°F)	78	80	80.5	81	83	80.4	79	82	84	83	77.6	79.7
Relative Humidity (%)	86	77	91	78	82	76	74	83	90	86	85	88

Unit 4 □ Construction and Interpretation of Wind Rose

Structure

4.1 Definition

4.2 Features

4.3 Construction

4.4 Uses

4.5 Example

4.1 Definition

Wind rose is a diagram showing the relative frequency of wind directions at a place.

4.2 Features

- 1) It is a graphic tool used by meteorologists.
 - 2) It gives a succinet view of wind direction.
 - 3) It represents the prevailling winds.
 - 4) It is associated with climograph.
 - 5) It represents the calm condition of a month.
-

4.3 Construction

The directions of the 12 months of a place is to be represented by a wind rose diagram, following the steps given below:

- 1) A circle is to be drawn on the basis of average value of cxalm condition. It can also be drawn representing maximum value of the calm condition.
- 2) The value of the calm conditions need to be write in the circle.
- 3) The straight lines are to be drawn (total 8) at 45° angle concentrating the centre circle.
- 4) The each 8 lines reepresent 8 wind direction. The straight lines should be drawn according to the average value wind directions of the 12 months on a certain scale.
- 5) The terminal points of the each 8 lines need to be joined by a boundary lines (extra portions of each lines need to be erase).
- 6) The directions of each lines should be mentioned.
- 7) The graphical scale and heading of wind rose diagram need to be write.

4.4 Uses

- 1) It is daily use to understand the monthly or yearly changes of wind direction and its stability of a place.
- 2) It is useful to represent the sea breeze and land breeze of the coastal areas.
- 3) It helps to understand the daily and or seasonal changes of atmosphere, especially wind condition.

4.5 Example

Wind Direction:

Table for wind direction (Wind Rose diagram)

Wind Direction	N	NE	E	SE	S	SW	W	NW	Calm
No. of days	2	15	7	5	6	37	5	4	13
Scale 1cm = 5 Units	0.4	1	1.4	1	1.2	7.4	1	0.8	0.5 cm radius

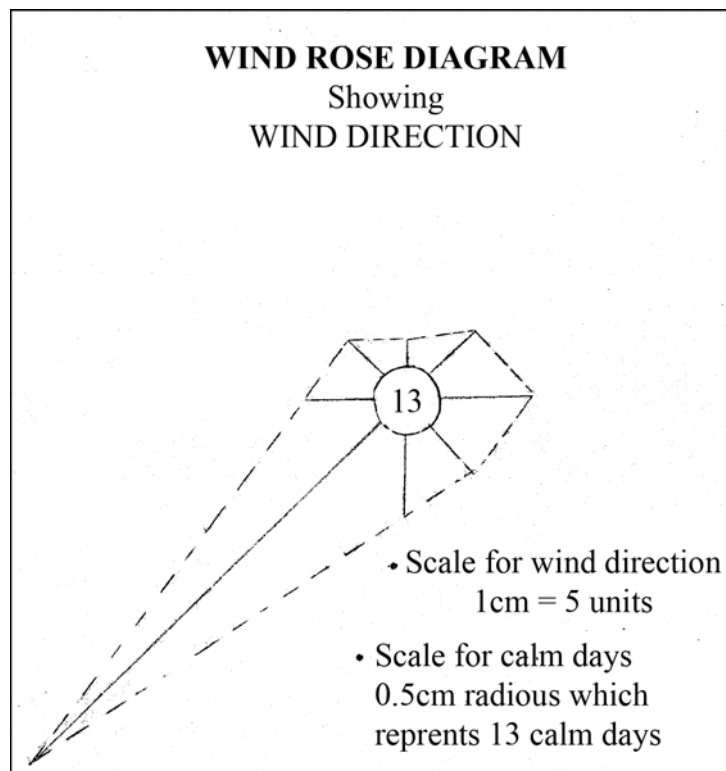

Unit 5 □ Construction and Interpretation of Climatic Chart

Structure

5.1 Introduction

5.2 Construction

5.3 Data for Climatic Chart

5.4 Representation of Climatic Chart

5.5 Drawing of Climatic Chart

a) Diagram in Two Frames b) Diagram in Four Frames c) Diagram in Single Frame

5.1 Introduction

Climatic Chart provides an overview of the climate at a place. It helps to understand the association between temperature, pressure, relative humidity and rainfall.

5.2 Construction

In this chart four elements of weather have been represented on the vertical (y-axis) and time on the abscissa (x-axis). The given climatic chart depicts the temperature, pressure, relative humidity and rainfall for three months of August, September and October for 2005 at Alipore, Kolkata at 8.30 hours. The temperature is depicted with a red curve, pressure with brown curve and relative humidity with blue curve. Rainfall is depicted using bars. On the ordinate, the scale for temperature, pressure, relative humidity and rainfall is 1 cm presents 5°C, 10 mb, 10% and 10mm respectively. On the abscissa 1 cm represents 5 days.

The climatic conditions prevailing at Alipore, Kolkata during August - October, 2005 depict moderate to high temperature ranging from 25°C on September to 35°C on September. Temperature fluctuations are relatively lower in August and October. However, the temperature in October is generally lower than in August.

Pressure follows the pattern of temperature and varies between 990 mb and 999 mb on September and October respectively. Pressure too fluctuates with temperature and in general high temperature is associated with low pressure barring few days when high temperature is not associated with low pressure probably on account of the influence of other weather elements. However, pressure increases continuously towards the end of October coinciding with decline in temperature.

Relative humidity fluctuates considerably during these three months and ranges from around 60 per cent on October to nearly 100 per cent for certain days in September and October. It is interesting to observe that the peak in relative humidity in September and October is associated with a dip in pressure as well.

Rainfall fluctuates more than the other three elements during these three months.

While there is practically no rainfall from mid to end of October; all through August to October beginning irregular rainfall is observed. The rainfall was maximum on the 5th of October 2005 (79.0 mm). In August, more frequent and copious rainfall occurred during 5th to 15th of the month; and in September, more frequent and copious rainfall occurred during 10th to 20th of the month. As expected copious rainfall days coincide with days of high relative humidity.

Thus, the three months of August - October are months of moderate though fluctuating temperature and low pressure, moderate to high relative humidity and moderate to high rainfall. The only exception is from middle to end of October when temperature starts declining and pressure increasing. Fluctuations in relative humidity are more prominent and rainfall is negligible. Thus, the four elements of weather are associated and reflect that during the three months Alipore, Kolkata experiences rainy climate and October end reflects the end of rainy season on one hand and probably marks the gradual ushering in of the winter season over the following days.

5.3 Data for Climatic Chart

Average temperature (°C)	Rainfall (mm)	Relative humidity (%)	Pressure (mb)
25	79.0	68	999.5
24	61.1	67	998.2
27	4.9	67	995.7
28	0.9	60	990.2
26	11.6	60	991.5
22	39.9	65	996.6
20	49.2	67	997.9
24	0.04	60	998.1

5.4 Representation of Climatic Chart

This data of climatic chart can be represented in three different frames which can be considered as different methods. The methods are—

- (a) Diagram in two frames—
 - (i) One frame for temperature and Rainfall
 - (ii) Another frame for Relative Humidity and Pressure.
- (b) Diagram in four frames—
 - (i) One for Temperature, (ii) One for Rainfall, (iii) One for Relative Humidity
 - (iv) One for Pressure
- (c) Diagram in single frame— Here Temperature, Rainfall, Relative Humidity and Pressure are plotted in a single frame based on their respective scales.

5.5 Drawing of Climatic Chart

CLIMATIC CHART
(A) Diagram in two frames

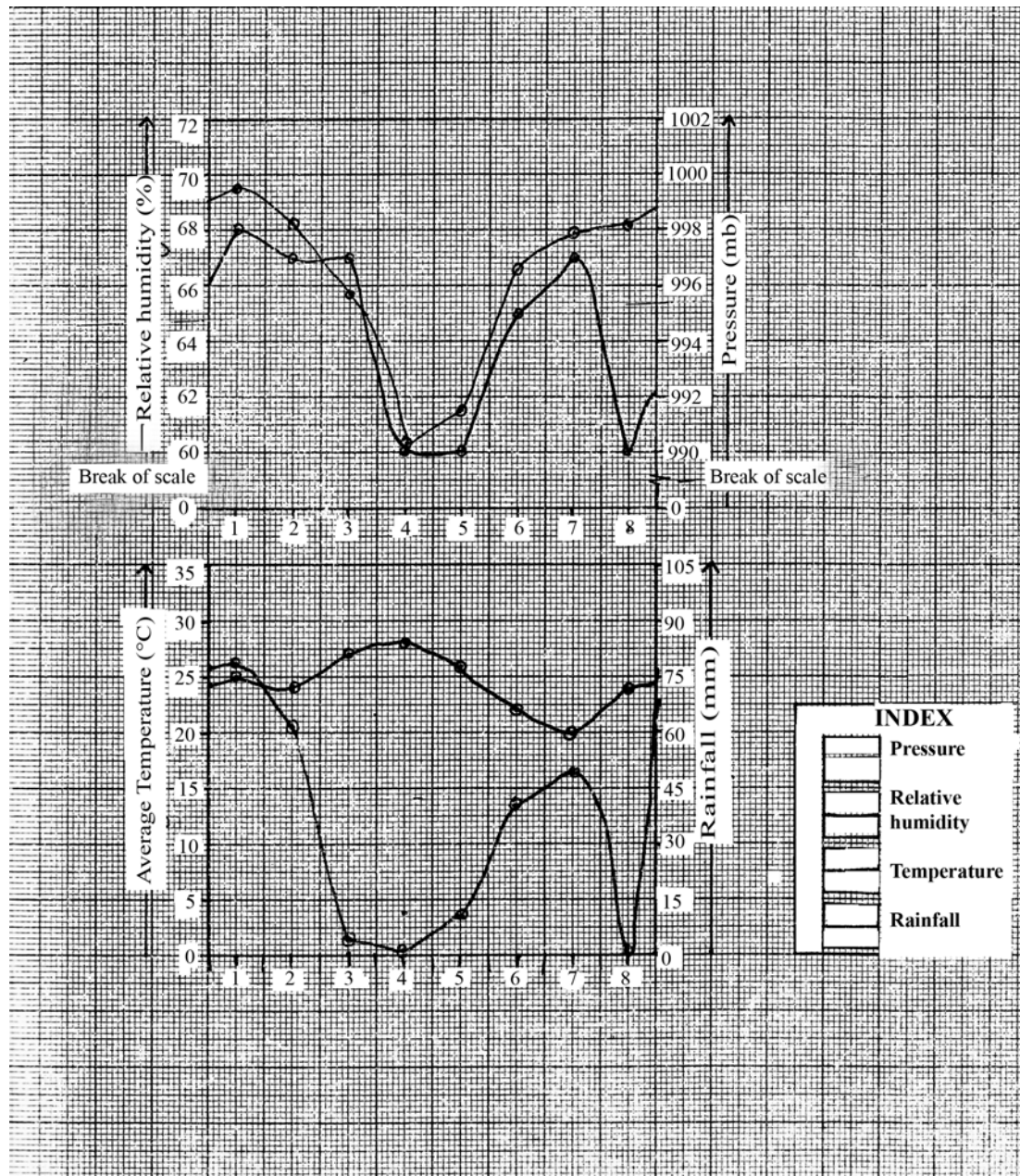

CLIMATIC CHART
(B) Diagram in four frames

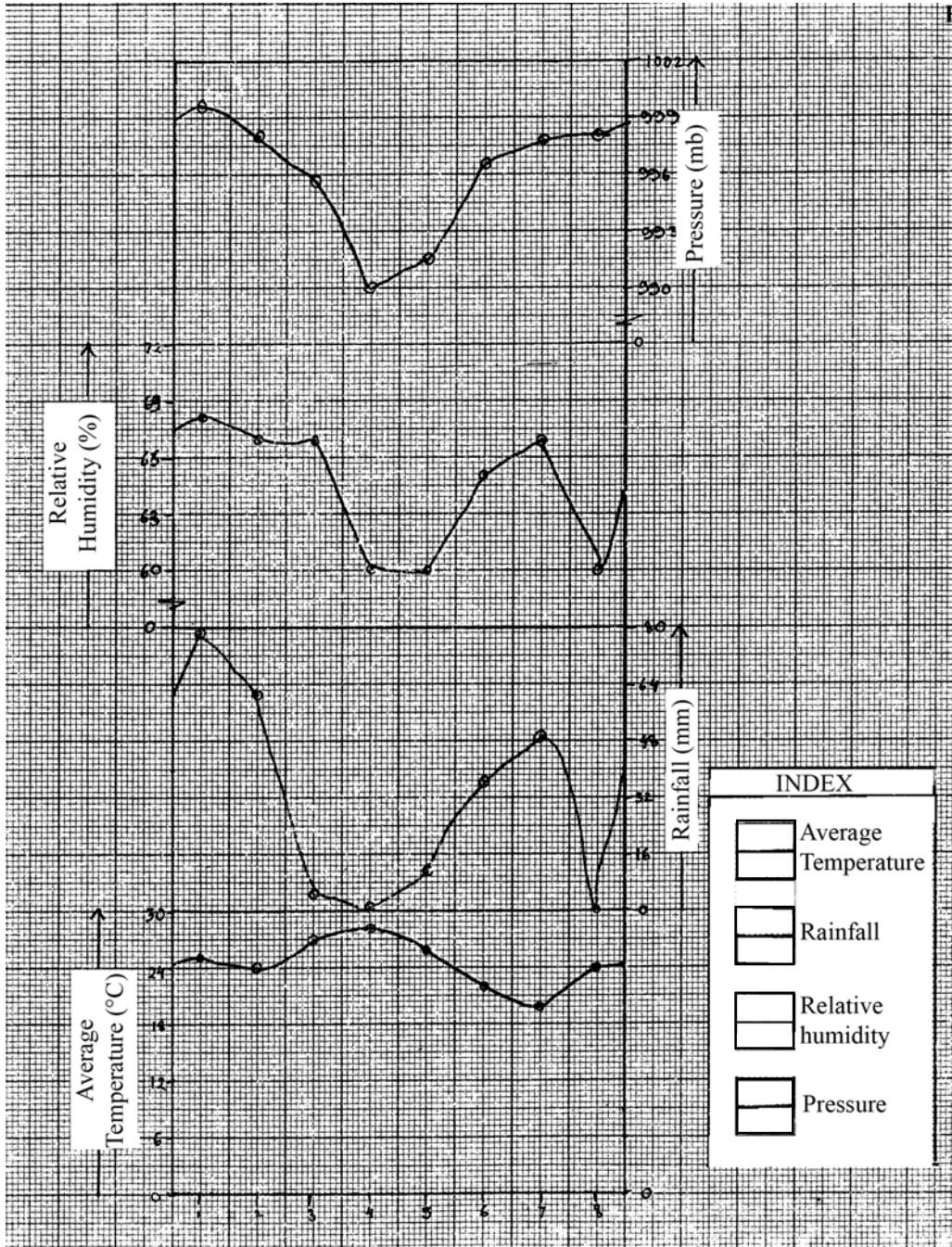

CLIMATIC CHART
(C) Diagram in single frame

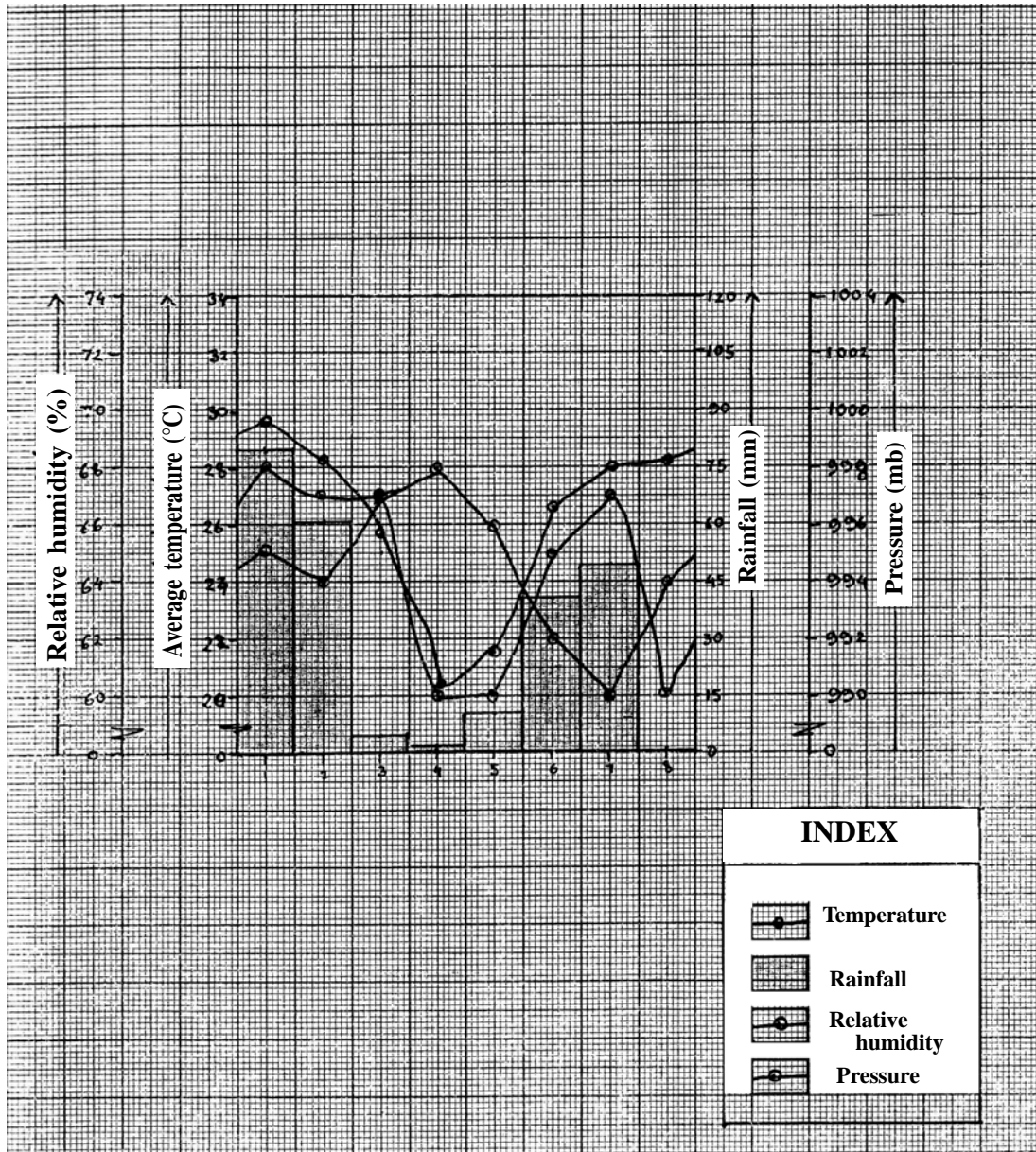

Unit 6 □ Construction and Interpretation of Ombrothermic Chart

Structure

- 6.1 Introduction
 - 6.2 Construction
 - 6.3 Data table for Ombrothermic Chart
 - 6.4 Drawing of Ombrothermic Chart
 - 6.5 Interpretation of the Diagram
-

6.1 Introduction

Ombrothermic Chart is a graph technique developed by Emberger *et. al* (1963) to identify water deficiency/stress conditions for plant growth. The word 'Ombrothermic' can literally be split up into 'ombro' i.e. 'relating to precipitation' and 'thermic' i.e. 'related to temperature'.

6.2 Construction

This method graph represents mean monthly temperature (°C) and monthly precipitation (mm) on the vertical axis. The scale of the temperature is generally associated on the left and precipitation on the right. The temperature scale is generally half value that of precipitation. The temperature and precipitation are usually plotted against on axis of time (horizontal axis)—generally over a year for each month. The temperature are indicated by a red curve, whereas precipitation is represented by a blue curve.

The resulting ombrothermic chart identifies water deficiency conditions, i.e. months with unfavourable conditions for plant growth. Plants are under water stress during the months when the precipitation curve drops below the temperature curve and plants are under temperature stress when the temperature curve drops below the freezing mark (0°C).

When the curve of precipitation exceeds that of the temperature it is referred to as the wet period or water surplus period. On the other hand, when the temperature curve is higher than that of precipitation, it is referred to as dry or *Xeric Period*. This can be represented by the following equation :

$$2t^{\circ} > P = > \text{dry/xeric}, \quad 2t^{\circ} < P = > \text{wet/water surplus.}$$

Thus, ombrothermic chart represents the complex spatial relationships between temperature and precipitation. This relationship is used for identifying *drought related phenomena* as well as hydrological stress due to excessive amount temperature. Thus, the chart technique offers the possibility to highlight gradual shift that occur in the season pattern, then relative lengthening/contracting, as well as corresponding

seasonal drought conditions as they both tend to neutralize the impact of each other. The balance of the two main elements of weather and climate tend to determine the climate of the region and hence have an implication for plant growth in the area as they determine water surplus or xeric periods.

6.3 Data table for Ombrothermic Chart

Table: 1 Station A

Months	Temperature	Rainfall (mm)
J	16	3.0
F	18	12.0
M	22	14.0
A	25	140.0
M	27	400.0
J	28	1021.0
J	27	918.0
A	27	605.0
S	26	415.0
O	25	142.0
N	21	59.0
D	19	0.0

Table: 2 Station B

Months	Temperature	Rainfall (mm)
J	18	4.0
F	19	25.0
M	24	8.0
A	30	71.0
M	31	121.0
J	31	170.0
J	30	318.0
A	29	165.0
S	28	302.0
O	27	41.0
N	23	0.0
D	19	0.0

6.4 Ombrothermic Chart of Station 'A'

Showing

THE RELATIONSHIP BETWEEN RAINFALL & TEMPERATURE

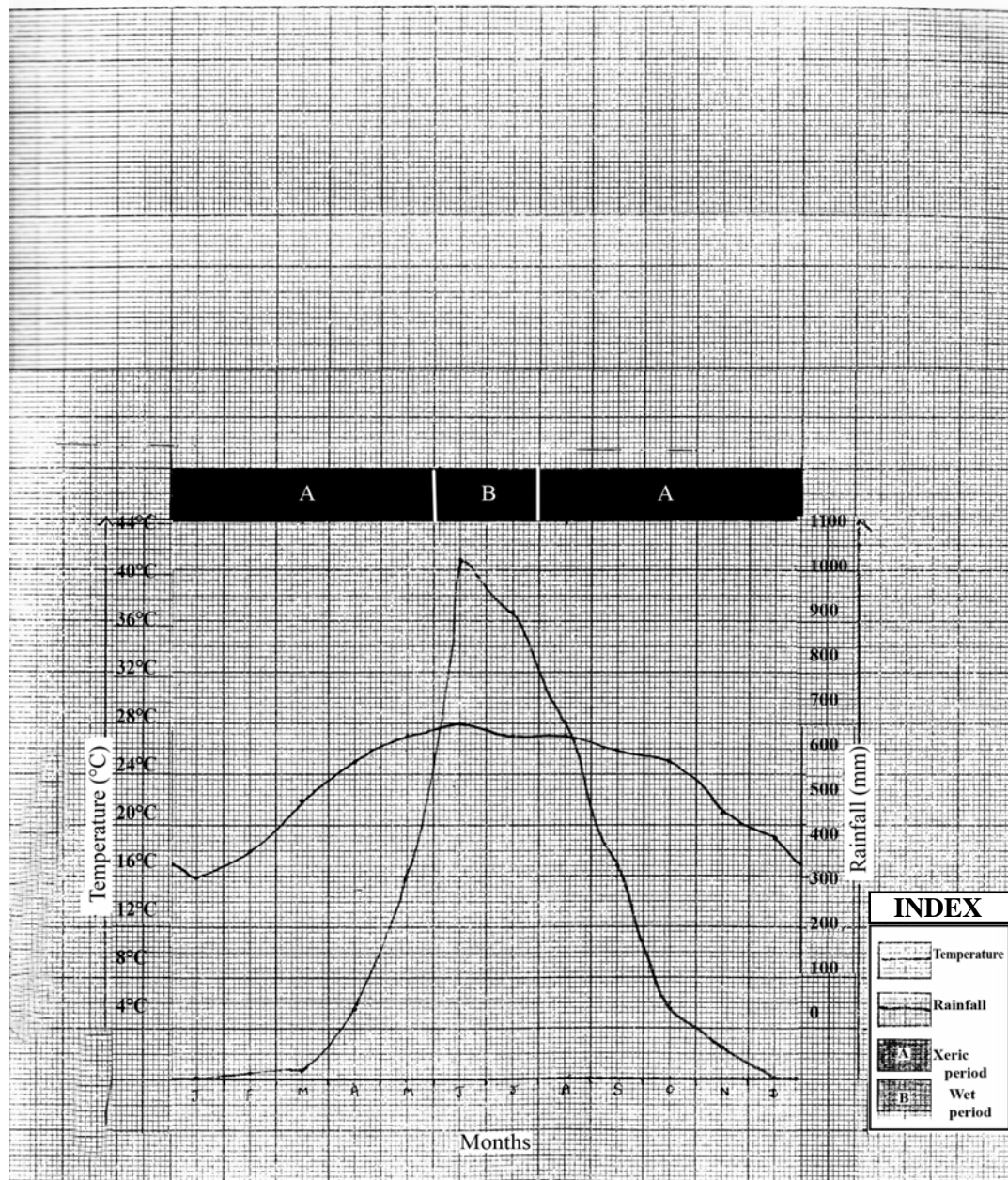

6.5 Ombrothermic Chart of Station 'B'

Showing

THE RELATIONSHIP BETWEEN RAINFALL & TEMPERATURE

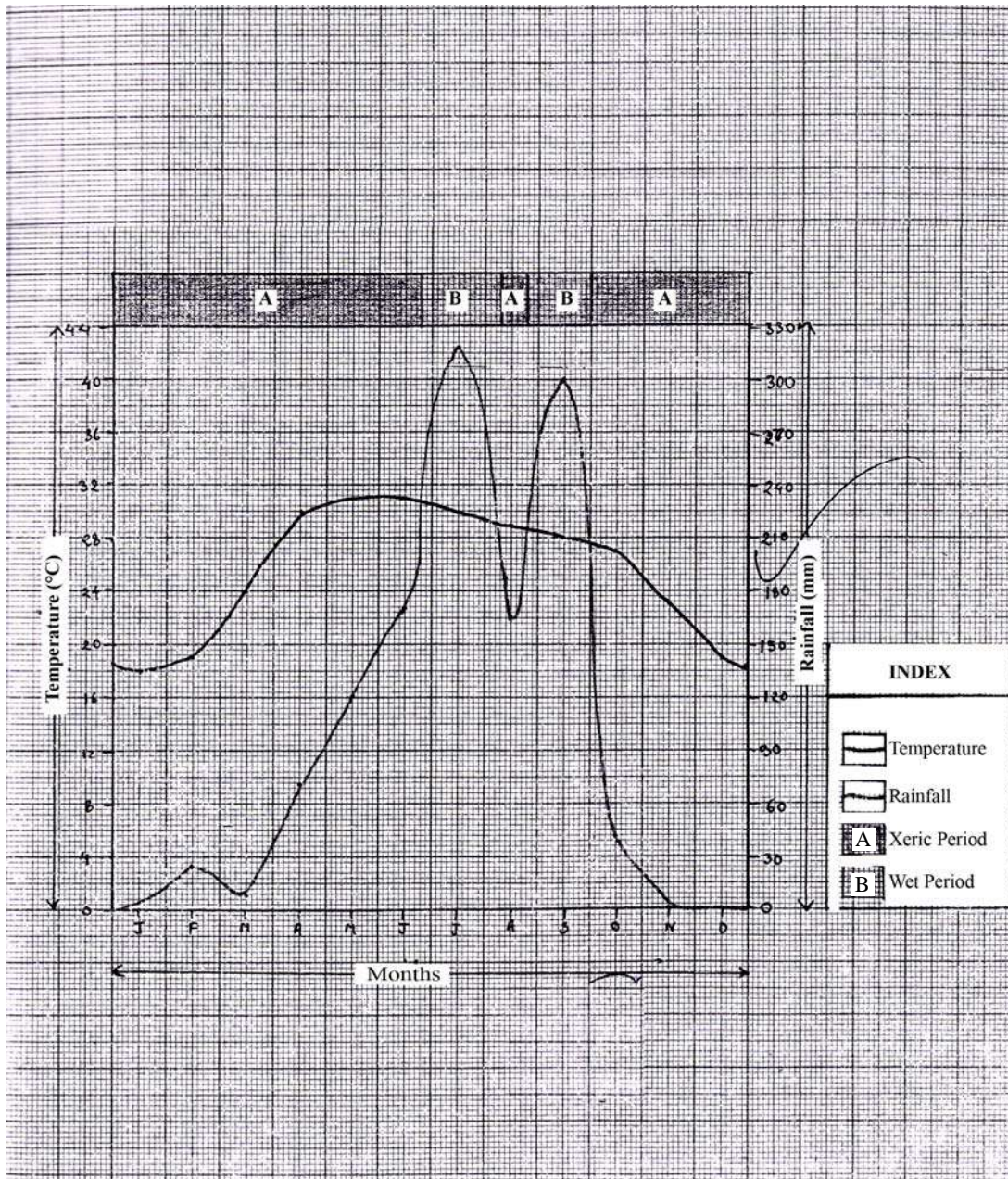

6.5 Interpretation

In both the Ombrothermic chart, there are two periods—xeric period and wet period. When the temperature is higher than rainfall in Ombrothermic chart that is called **Xeric Period** and when then temperature is lower than the rainfall that is called **Wet Period**.

In Ombrothermic chart 'A' the **Xeric Period** starts from the middle of August and continues to the middle of May and June. In Ombrothermic chart 'B' there are two Xeric periods are present, one starts from the October and continues to June, it is the longer **Xeric Period**. Another Xeric Period; the smaller one, starts and ends in August.

In chart 'A' the **Wet period** starts from June and ends in the middle of August. In chart 'B' the wet period is divided in two periods. One starts from the end of June to starting of August and another wet period starts from end of August to September.

Summary/Learning Outcomes

The learning outcomes of the blocks are :

- 1) The use of different instrument for measuring weather elements is understood by the learners and they became capable of measuring such elements and describe the weather condition.
- 2) The study of daily weather map of India helps the learners about the salient features of different seasons of India and their key element which enhance their skill to interpret different weather reports.
- 3) The study of construction, process of climograph, wind rose, climatic chart, ombrothermic chart help the learners to understand the condition and they can interpret those very well.
- 4) Different aspects of climatology are analysed in the block which help the learners to understand and prepare particular assignment and make them capable to solve problems related to the topic.
- 5) This practical experience will definitely help the learners to understand and strengthen the theoretical base of climatology and enhanced their skills in this discipline.

Questions:

1. Measure the Mean daily temperature using the given instrument and interpret it.
2. Measure the Air pressure the given instrument and interpret it.
3. State about the basic criteria to identify the monsoon, pre-monsoon and post-monsoon season from a Daily Weather Map of India.
4. State about the major heads to interpret a a Daily Weather Map of India.
5. State about the Pressure and Wind Condition of the given Daily Weather Map of India with the help of suitable drawing.
6. Discuss about the Sky Condition and Rainfall/Precipitation of the given Daily Weather Map of India with the help of suitable drawing.
7. Explain about the Pressure-Wind-Cloudiness-Rainfall corelationsof the given Daily Weather Map of India with the help of suitable drawing.
8. Discuss about theother Atmospheric Phenomena, Sea Condition and Weather Forecasting of the given Daily Weather Map of India with the help of suitable drawing.
9. Draw and interpretation of Climograph using the given data.
10. Prepare a Wind Rose diagram and interpret it.
11. Prepare a Climatic Chart and interpret it.
12. Construct a Ombrothermic Chart and interpret it.

References:

- Hammond, R. and Macullagh, P.S. (1974): Quantitative Methods in Geography, Clarendon Press, Oxford.
- Mishra, R.P.: Elements of Cartography.
- Monkhouse, F.J. and Wilkinson, H.R. (1789): Maps and Diagrams: Their compilation and construction, P.I. Pub. Pvt. Ltd., New Delhi.
- Robinson, A. H., Sale, R.D., Morrison, J. (1980): Elements of cartography, Wiley, New York.
- Saha, P.K. and Basu, P. (2003): Practical Geography: A Laboratory Monepal, Kolkata.
- Sarkar, A. (1997): Practical Geography: A systematic Approach, Orient Longman Ltd., Hyderabad.
- Singh, R.J., (1991): Elements of Practical Geography, Kalyani Publishers.
- Kimerling, A.J., Buckley, A.R., Muehrcke, P.C., Muehrcke, J.O. (2011). Map Use: Reading, Analysis, Interpretation, 7th ed, Esri Press.

NOTES